

# ZWZ

## Transmission Bearing Catalogue

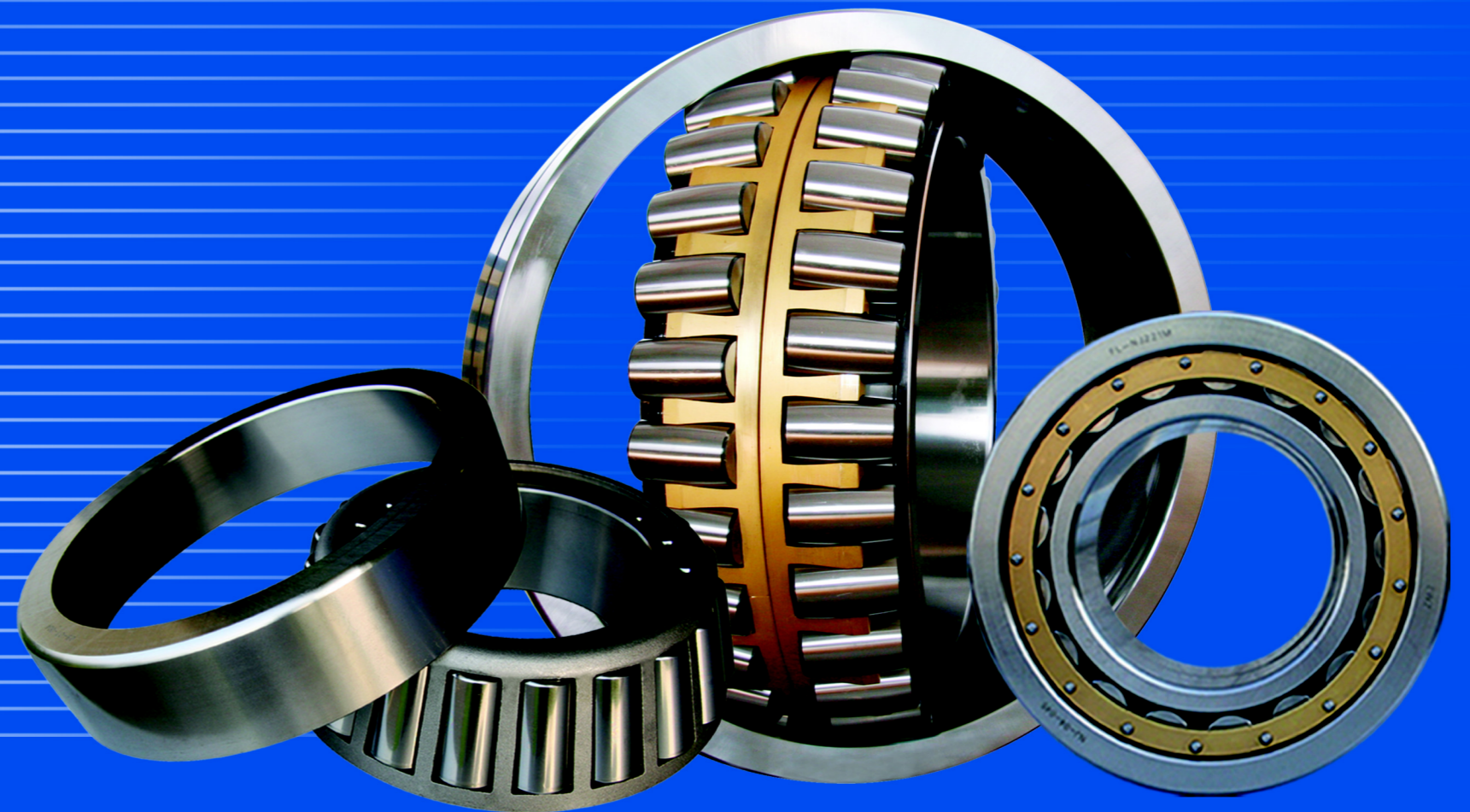

**Size Range:** Nine types of gearbox bearing with OD  $\phi$  30-  $\phi$  2500mm.

**Applications:** Industrial Gearbox, Wind Turbine Gearbox and Vehicle Gearbox, etc.

**Manufacturing Capability:** ZWZ can provide more than 2000 specifications produce, 1 million gearbox bearings every month. 35 days by through hardened steel, and 50 days by case hardened steel.

## 1 Selection of Bearing

The variety of kinds and types, dimensions of power train bearings makes the selection of the most appropriate bearings very important in order to achieve the expected functions of the mechanical devices. Analyses and evaluations from different viewpoints on the factors to be considered must be made in order to choose the bearings. There are no special regulations on such selection procedures, but the steps below are followed:

Understand the work conditions of the mechanical device and the bearings.

Define the requirements on the bearing to be chosen.

Choose the type of the bearing.

Choose the configuration of the bearing

Choose the dimensions of the bearing.

Choose the specifications of the bearing

Choose the mounting method of the bearing

### 1.1 The using conditions and the surrounding conditions of the bearings

Correct definitions on the application position in the mechanical device and the use conditions and surrounding conditions are the pre-conditions of choosing the proper bearing. For this purpose, the following figures and data are required:

The functions and structure of the mechanical device.

The application position

Loads (how big and in which directions);

Rotate speed.

Vibration and shock.

Temperature of the bearing (surrounding temperature and rises).

Surrounding ambience (corrosion, cleanness, lubrication).

### 1.2 The Selection of Bearing Type

Items of Analyses		Methods for Choose
Mounting space	Those can be put in the mounting space	Since the rigidity and strength of the shaft have been considered in the designing, first of all the inner diameter of the bearing must be determined. But there are too many dimensional series and types, the most appropriate type must be chosen.

Load	Strength, direction and nature of the load [the load carrying capacity is indicated by basic load rating whose value is provided in the bearing dimension tables]	The load is subject to changes, such as the amount of the load, whether there is only radial load or not, whether the axial load is in single-direction or double direction, the amount of vibration or shock and others,. These factors must be considered before choosing the most appropriate bearing type. Normally, the radial load carrying capacity of the bearings with the same ID are listed in the following order: [deep groove ball bearing < angular contact ball bearings < cylindrical roller bearings < tapered roller bearings < spherical roller bearings]
Rotating speed	Those are suitable for the mechanical rotations. [the limit value of rotating speed is indicated by limiting speed (rpm) whose figures are provide in the bearing dimension tables.]	The limit speed of the bearing rests with not only the bearings type but also bearing dimensions, cage type, precision, load carrying conditions, and lubrication methods. These factors must be considered for the choice. The following bearings are applied for high speed rotation: [deep groove bearings, angular contact ball bearings, cylindrical roller bearings]
Rotating precision	Those can satisfy the rotation precision requirements. [The dimensional precision and rotation precision have been standardized according to national standards and bearing types.]	Machine tool spindles, gas turbines and control machines entail high rotation precision, high speed and low friction. Bearings with precision degree 5 or over should be applied in the cases. Normally the following bearings are applied: [deep groove ball bearings, angular contact ball bearings, cylindrical roller bearings]
The relative leaning of the inner ring and outer ring	Reason of leading to the relative leaning of the inner ring and outer ring must be analyzed (such as the load-induced bending of the shaft, poor precision of the shaft and housing or mounting error), and the bearings that fit these conditions should be chosen. [The permissible sloping angle is indicated in the notes to the tables of bearing dimensions]	If the relative leaning between the inner ring and outer ring is too big, the inside load thereof shall do harm to the bearings. So bearing types that can carry this leaning should be chosen. Normally, the allowable sloping angle increased with the following order: [cylindrical roller bearings, tapered roller bearing, deep groove ball bearings (angular contact ball bearings), thrust ball (spherical roller) bearings]
Mounting and dismounting	Check the frequency and methods of mounting and dismounting of the bearings regularly.	If too much mounting and dismounting, choosing cylindrical roller bearings with separable inner ring and outer ring, needle roller bearings and tapered roller bearings is comparatively convenient. With adapter or withdrawal sleeve, self-aligning ball bearing with tapered bore and spherical roller bearings with tapered bore are convenient for mounting and dismounting.

## 1.2 The selection of bearing Collocation

Normally, the shaft is supported by two bearings in radial and axial directions. Then, one of the bearings is called the fixing-end bearing which carries the load in radial and axial directions. It controls the comparative axial movement between the shaft and the bearings. The other one is called the free-end bearing that only carries the radial load and the bearing can comparatively move in the axial direction in order to solve the problems of expansion of the shaft caused by changed in the temperature and the clearance error in mounting.

For the fixing-end bearing, it must be chosen from which the axial movement can be prevented. For the free-end bearing, it must be chosen to use its sliding surface to make axial movement (such as cylindrical roller bearings) or use its mounting surface to move (such as radial ball bearings). On the comparatively short shaft, if there are no differences between the two bearings, the bearings that only move in the fixed single axial direction (such as radial thrust ball bearings) are preferable.

### Bearings on the fixing end and the free end

	Content	Applicable bearing types
Bearings on the fixing end	Fix the bearing in the axial direction Choose bearings that can carry both the radial load and the axial load In order to carry double-direction axial load, strength must be considered according to the amount of the axial load while mounting	Deep groove ball bearings Combined angular contact ball bearings Self-aligning ball bearings Cylindrical roller bearings with flanges (NUP and NH types.) Double-row tapered roller bearings Spherical roller bearings
Bearings on the free end	The bearing must adapt to the shaft expansion caused by the changes in temperature while working and adjust the bearing position in the axial direction. Only the bearing with separable inner ring and outer ring that can carry radial load should be chosen.	Separable type: Cylindrical roller bearings (NU or N type) Non-separable types Deep groove ball bearings Combined angular contact ball bearings (back-to-back arrangement) Double-row angular contact ball bearings
	With non-separable bearings, there should be a clearance between the outer ring and housing in order to adapt the bearing to the shaft expansion in the axial direction. Sometimes, the adaptation is achieved with the contact surface between the shaft and the inner ring.	Self-aligning ball bearings Double-row tapered roller bearings (3700 type) Spherical roller bearings
Regardless of fixing end or free end	When the distance between the tow bearings is small, and the effects of shaft expansion are not important, two angular contact ball bearings or tapered roller bearings that can carry axial load can be used together in face-to-face or back-to-back arrangement. Use screw nut or filling piece to adjust the axial clearance after mounting.	Deep groove ball bearings Angular contact ball bearings Self-aligning ball bearings Cylindrical roller bearings (NJ and NF types) Tapered roller bearings Spherical roller bearings

Vertical shaft	Bearings that can carry both radial load and axial load should be chosen for the fixing end. If the axial load is too big, use the combination of thrust bearings and radial bearing. Similarly, only bearings that can carry radial load should be used to adapt to the shaft expansion.	For fixing end Combined angular contact ball bearing (back-to-back arrangement) Double-row tapered roller bearings (3700 type) Combined thrust bearing and radial bearing arrangements
----------------	--	---

## 1.4 The selection of bearing dimensions

### 1.4.1 Life of bearing

When the bearing is carrying load, material fatigue shall happen even under normal operating conditions due to the effects of changing load on the raceways of rings and the sliding surface of the rolling elements, and it will cause scaling damage to the raceways and the sliding surface (called flaking or spalling).

The total number of revolutions before such scaling happens is called the “(Fatigue) life” of the bearing.

The bearing (fatigue) life varies greatly even for those with the same structure, dimensions, materials and manufacturing processes under the same rotation conditions.

Because the material fatigue is of diversity, it must be considered statistically. Suppose a number of bearings of the same specification are operated individually under the same working conditions. After a certain period of time, 10% of the fail as a result of flaking caused by rolling fatigue. In this case, the total number of revolutions is defined as the fatigue life rating. (i.e. bearing life reliability 90%)

When the bearings rotate at constant speed, its life can also be expressed with total rotation time.

In fact, however, other damage or impair may happen besides fatigue scaling.

The damage of impair may be avoided by choosing the correct bearing, mounting method and lubrication.

### 1.4.2 Basic dynamic load rating

Basic dynamic load rating indicates the fatigue resistant capacity (i.e. load carrying capacity). It shows that with pure radial load (for radial bearings), and with the presumption of running inner ring and motionless outer ring (or vice versa), the basic rating life can exceed 1 million rotations. The basic load rating for radial bearings and thrust bearing is called radial basic load rating respectively, indicated by Cr and Ca, whose values are provided in the bearing dimension tables.

### 1.4.3 Basic life rating

Formula (1) shows the relations among basic dynamic load rating, equivalent dynamic load rating and basic life rating.

When the rotation speed is constant, it is more convenient to express the life rating in time, as shown in formula (2).

$$\text{(Total rotation number)} \quad L_{10} = \left(\frac{C}{P}\right)^p \dots\dots\dots (1)$$

$$\text{(Time)} \quad L_{10h} = \frac{10^6}{60n} \left(\frac{C}{P}\right)^p \dots\dots\dots (2)$$

$L_{10}$ : basic life rating, revolutions

$L_{10h}$ : basic life rating, h

P: equivalent dynamic load rating, N{kgf}

C: basic dynamic load rating, N{kgf}

n: rotational speed, rpm

p: life index

ball bearing.....P=3

roller bearing.....P=  $\frac{10}{3}$

Therefore, we assume the working conditions of the bearing are: equivalent dynamic load is P, rotation speed is n, then the basic dynamic load rating that satisfies the design requirement of the bearing can be calculated with formula (4). From the dimension tables, we can select the bearing that can meet the requirement of value C, then we can define the dimension of the bearing.

We use life factor (fh) and speed factor (fn) and get the following formula:

$$C=P \left(L_{10h} \times \frac{60n}{10^6}\right)^{\frac{1}{p}} \dots\dots\dots (3)$$

Life factor:

$$L_{10h} = 500 fh^p \dots\dots\dots (4)$$

$$fh = fh \frac{C}{P} \dots\dots\dots (5)$$

Speed factor:

$$fn = \left(\frac{10^6}{500 \times 60n}\right)^{\frac{1}{p}} = (0.03n)^{\frac{1}{p}} \dots\dots\dots (6)$$

We can easily get fh, fn and L10h with the calculated figure [Reference figure].

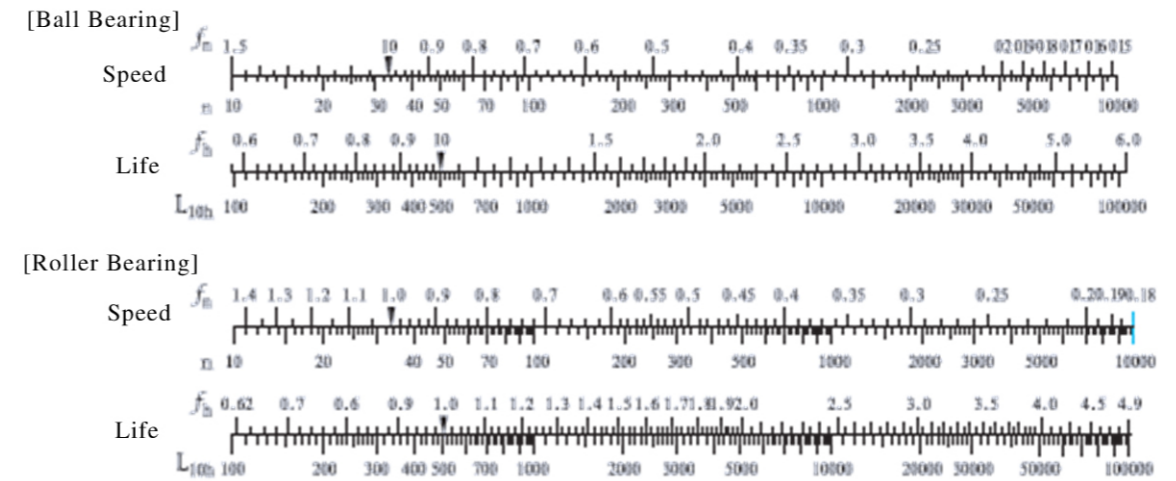

### 1.4.4 Correction of basic dynamic load rating based on temperature and treatment on stability of bearing dimensions

When applied in high temperature, the internal microstructure in the material shall change and the hardness shall be decreased, while the basic dynamic load rating shall be smaller than in normal temperature. And the changed microstructure in the material shall not recover even when the bearing is put back in the normal temperature again.

Therefore, under high temperature conditions, the basic dynamic load ratings must be multiplied by the temperature factors listed in table 1 for correction purpose.

Table 1 Temperature factors:

Working temperature °C	125	150	175	200	250
Temperature factor (fT)	1	1	0.95	0.90	0.75

If working in the temperature of over 120°C for a very long time, the dimensions for bearings with only normal heat treatment shall change greatly, measures must be taken to stabilized the dimensions.

The code names for these stabilization measures and the applicable temperature ranges are provided in Table 2. The hardness of the bearing, however, shall be reduced with the above treatment. Sometimes, the basic dynamic load rating will also decrease.

Measures for dimensional stabilization

Code name	Relative temperature range
$S_0$	Over 100°C to 150°C
$S_1$	Over 150°C to 200°C
$S_2$	Over 200°C to 250°C

### 1.4.5 Correction of life rating

Formula (1) shows the basic life rating (L10) of 90% reliability. Based on different applications, high-reliability life with reliability being over 90% will be required under some conditions.

In addition, special materials sometimes shall elongate the bearing life, even lubrication or differences in working conditions can have effects on bearing life. The bearing life after taking these factors into consideration is called the corrected life rating, which is calculated with formula (7).

$$L_{na} = a_1 a_2 a_3 \dots \dots \dots (7)$$

Here is,

$L_{na}$ : corrected life rating,  $10^6$  revolution

the life with 100-n% reliability (n% loss rate) after taking the bearing features and operating conditions into consideration.

$L_{10}$ : basic life rating,  $10^6$  revolution (reliability 90%)

$a_1$ : reliability factor..... referring to (1)

$a_2$ : Material factor..... referring to (2)

$a_3$ : Application condition factor..... referring to (3)

[Note] When select bearing dimension according to  $L_{na}$  higher than 90%, the shaft and shell rigidity shall be specially concerned.

#### (1) Reliability factor $a_1$

When calculating the corrected life rating for those with reliability of greater than 90% (i.e.the loss if not greater than 10%),factor  $a_1$  in Table 3 should be employed.

Table 3 Reliability factor  $a_1$ :

Reliability, %	$L_{na}$	$a_1$
90	$L_{10a}$	1
95	$L_{5a}$	0.62
96	$L_{4a}$	0.53
97	$L_{3a}$	0.44
98	$L_{2a}$	0.33
99	$L_{1a}$	0.21

#### (2) Material factor $a_2$

The bearing characteristics relate to service life may vary with the bearing materials (steel type, quality), manufacture processes and design. In these cases, the factor  $a_1$  should be used for correction purpose.

If the material is quality vacuum degassed bearing steel or with quite minimum amount of inclusion,  $a_2 > 1$ . For normal bearing material steel,  $a_2 = 1$ .

#### (3) Application condition factor $a_3$

This factor  $a_3$  is used for correction purpose when the bearings are applied in conditions (especially lubrication) that shall affect the service life of the bearings.

We can let  $a_3 = 1$  under normal lubricating conditions and let  $a_3 > 1$  if the conditions are excellent.

Under the following circumstances, let  $a_3 < 1$ :

- If the kinematic viscosity of the lubricant decreases during the working time of the bearing:  
Ball bearings .....less than  $13\text{mm}^2/\text{s}$ {13ces}  
Roller bearings .....less than  $20\text{mm}^2/\text{s}$ {20ces}
- When the rotational speed is extremely low, the product of the pitch diameter of the rolling elements and the rotational speed is less than 10000.
- When the lubricant has inner ring and outer ring is very big.

[Note] When the hardness decreases under high temperature circumstance circumstances, the basic dynamic load rating must be corrected (see Table 1)

### 1.4.6 Equivalent dynamic load

Bearings usually carry the combination of radial load and axial load, and the load conditions are varied, such as the changes in the amount and so on.

Therefore, the actual load can not be directly compared with its dynamic load rating.

In this case, it is necessary to convert the actual load into a perceived load with definite amount and direction that passes the bearing center. The bearing with this perceived load shall have the same life as with actual load and the same rotational speed.

This perceived load after conversion is called the equivalent dynamic load, indicated by P.

the equivalent dynamic load of the radial bearings and thrust bearings ( $\alpha = 90^\circ$ ) can be calculated with formula below:

$$P = XF_r + Y F_a \dots\dots\dots (8)$$

P: equivalent dynamic load, N{kgf}

For radial bearings, it is expressed as  $P_r$ : radial dynamic load

For thrust bearings, it is expressed as  $P_a$ : axial dynamic load

$F_r$ : radial load, N{kgf}

$F_a$ : axial load, N{kgf}

X: radial load factor

Y: axial load factor

(Load factors X and Y are given in the bearing dimension tables.)

For single-row radial bearings, when  $F_a/F_r \leq e$ , let X=1, Y=0.

Hence, in this case equivalent dynamic load  $P_r = F_r$

[e indicates the critical value of  $F_a/F_r$ , which is given in the bearing dimension tables.]

### 1.4.7 Basic static load rating

Partial permanent deformation will happen to the contact surfaces of the rolling elements and raceways when the bearing carries too heavy the static load or work at extremely low rotational speed. The amount of deformation shall increase with the growing load and shall affect the normal rotation when it exceeds certain limit.

The basic static load rating means the static load which can produce stress in the center of contact surface between the rolling elements carrying the maximum load and the raceways, the contact stress can be calculated as the following:

Ball bearings.....4200M  $p_a$  {429kgf/  $mm^2$  }

Roller bearings.....4000M  $p_a$  {408kgf/  $mm^2$  }

The total amount of permanent deformation of the rolling elements an raceway under such stress equals 0.0001 times of the diameter of the rolling elements.

### 1.4.8 Equivalent static load rating

Equivalent static load rating is a perceived load. When the bearing is motionless or rotates at extremely low speed, the contact stress in the center of the surface between the rolling elements carrying maximum load and the raceway under such perceived load shall be the same as that will happen in actual load conditions.

The radial load and axial load passing the bearing central line is used as the equivalent static load rating of radial bearing and axial bearing respectively.

Equivalent static load rating can be calculated with the following formula:

[Radial Bearing].....Calculated by the following two formulas, and take the larger value as result.

$$P_{or} = X_o F_r + F_a \dots\dots\dots (9)$$

$$P_{or} = F_r \dots\dots\dots (10)$$

### Safety factors

Although the permissible equivalent static load depends on the basic static load rating of the bearing, the use limit of the bearing restricted by the above-mentioned permanent deformation (the amount of partial surface hollow) will vary with the requirements on the functionality and the application conditions of the bearing.

Therefore, an empirical safety factor is defined in order to analyze the safe level of the basic static load rating.

$$f_s = \frac{C_o}{P_o} \dots\dots\dots (11)$$

$f_s$ : safety factor

$C_o$ : basic static load rating, N{kgf}

$P_o$ : equivalent static load, N{kgf}

Safety Factor :  $f_s$

Application conditions		$f_s$	
		Ball bearing	Roller bearing
Rotating in normal way	High rotational precision	2	3
	Under normal conditions	1	1.5
	With shock load	1.5	3
Under normal conditions (sometimes oscillating)	Rotating rarely	0.5	1
	With shock load or unevenly-distributed load	1	2

## 2、The limit speed of bearing

The rotational speed of the bearing is mainly restricted by the increase in temperature due to the frictional heat generated inside the bearing. When the rotational speed exceeds certain limit, the bearing shall fail to continue to rotate due to the burns.

Limit rotational speed of the bearing indicates the limit value of the rotational speed when there is no frictional heat that leads to the burns and the bearing can continuously rotate.

Therefore, the limit rotational speed of the bearing is subject to the bearing type, dimensions, precision, lubrication method, quality and amount of lubricant, material and design of retaining cage, loading conditions and other factors.

The limit rotational speed for different types of bearings using grease lubrication and oil lubrication are respectively given in the dimension tables of these bearings. These values indicate the limit values of rotation speed the bearings of normal design under normal loading conditions ( $C/P \geq 13$ ,  $F_a/F_r \leq 0.25$  or so).

In addition, the lubricant may be better than others in property, according to types and brand, but it may not be suitable for high speed rotation.

### Correction of limit rotate speed

Correction must be with formula (1) on limit rotational speed, when the loading condition  $C/P < 13$  (ie. the equivalent dynamic load  $P$  exceeds basic dynamic load rating  $C$  by 8% or so), or the axial load exceeds the radial load by over 25% in the combined load.

$$n_a = f_1 \cdot f_2 \cdot n \dots \dots \dots (12)$$

- $n_a$ : the corrected limit rotational speed, rpm
- $f_1$ : the correction factor related to the loading condition (Figure 1)
- $f_2$ : the correction factor related to the combined load (Figure 2)
- $n$ : the limit rotational speed under normal load conditions, rpm (see bearing dimension tables)
- $C$ : the basic dynamic load rating, N { kgf }
- $P$ : the equivalent dynamic load, N { kgf }
- $F_r$ : radial load, N { kgf }
- $F_a$ : axial load, N { kgf }

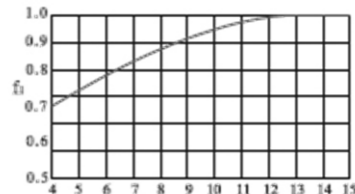

Figure 1: The correction factor  $f_1$  relative to load condition

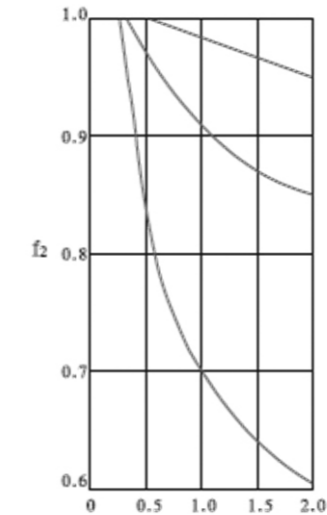

Figure 2: The correction factory  $f_2$  relative to the combined load

### Precautions for high-speed rotation

When the bearing rotates at high speed, especially at rotational speed approaching or exceeding the limit rotational speed given in the dimension tables, attention must be paid to the following issues:

- (1) Apply precision bearings
- (2) Analyze the internal clearance of the bearing (taking the reduction in internal clearance caused by the temperature increase into consideration)
- (3) Analyze the type of material of the cage (For high speed rotation, cages of copper alloy or PF resins are preferred. Cages of synthetic resins are also workable.)
- (4) Analyze the lubricating method (Circular lubrication, spurt lubrication, oil spray or gas lubrications are suitable for high-speed rotations.)

## 3、 Fits of bearings

### 3.1 Purpose of fit

The purpose of fit is to make the inner ring or the outer ring fixed to the shaft or housing so that no bad circular slide shall happen on the fit surface.

The bad circular slide (called creep deformation) will bring about abnormal heat, scratches on the fit surface (hence making the ground iron power enter into the bearing), vibration and other problems, which cause the insufficient functioning of the bearing.

Therefore, since the bearing rotates with load, normally the rings must have interference fit so that they are fixed to the shaft or the house.

#### 3.1.1 Dimensional tolerances and fits of shaft and housing

The dimensional tolerance of the metric shaft and housing bore have been standardized in the GB/T275-93 《The fits of Rolling Bearings with Shaft and Housing》. If the dimensional tolerances are available, we can define the fit of the bearing with the shaft or the housing.

The fit relations between the dimensional tolerances of the shaft and housing bore and the bearings with PO class

precision degree are given in Figure 1.

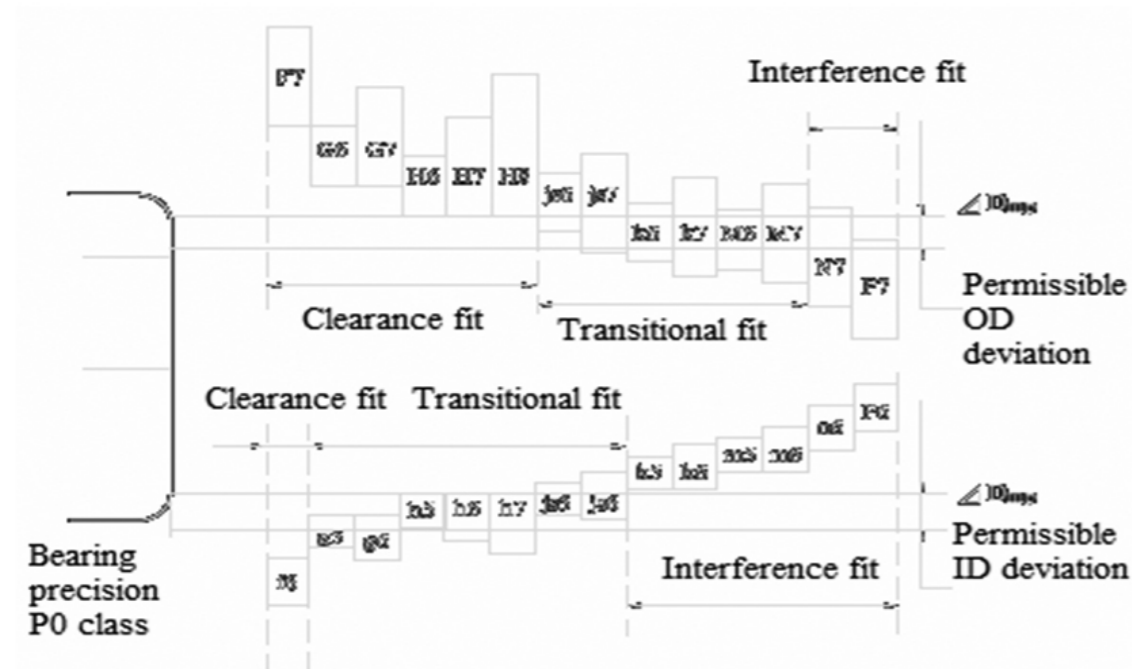

Figure1 Relations between dimension tolerances of shaft and housing bore and fit (bearings of P0 class precision).

### 3.1.2 The selection of fit

The selection of fit is made according to the following principles.

According to the direction and nature of applied load and which of the two rings rotates, the load carried by each of the rings can be divided into rotational load, static load or indeterminate direction load. The ring and carries rotation load or indeterminate direction load should use static fit (interference fit), and the ring carrying static load should use transitional fit or dynamic fit (clearance fit).

If the bearing load is big or there is vibrating or shock load, the interference fit should be increased. When using hollow

shaft, bearing box with thin wall or light alloy or plastic bearing box, the interference should also be increased.

If high rotation precision is required, the high precision bearing should be used, and the dimension precision of the shaft or bearing box should be increased to avoid too much interference fit. If the interference is too big, the geometric precision of the shaft or bearing box shall affect the geometric shape of the bearing rings, and accordingly damage the bearing rotation precision.

If both inner ring and outer ring of non-separable bearing (such as deep groove ball bearing) adopt static fits, the mounting and dismounting of bearing is very inconvenient. It's better to adopt dynamic fit for inner ring or outer ring.

#### (1) Effects of the load nature

According to its nature, bearing load can be divided into inner ring rotation load, outer ring rotation load and indeterminate direction load. The relations between them and the fit are shown as below.

Bearing rotational conditions	Figure example	Nature of load	Fit choice
Inner ring: rotating Outer ring: static Direction of load: fixed	 Static load	I.R. rotating load	I.R.: use static fit (interference fit)
Inner ring: static Outer ring: rotating Direction of load: Rotating simultaneously with outer ring	 Unbalanced load	O.R. static load	O.R.: use dynamic (clearance fit)
Inner ring: static Outer ring: rotating Direction of load: fixed Static load I.R. static load	 Static load	I.R. static load	I.R. use dynamic fit (clearance fit)
O.R. rotating load I.R. use dynamic fit (clearance fit) Inner ring: rotating Outer ring: static Direction of load: Rotating simultaneously with inner ring Unbalance load O.R. use static fit (interference fit)	 Unbalance load	O.R. rotating load	O.R. use static fit (interference fit)

Relations between load nature and fits



## (2) Effects of load magnitude

For inner ring with radial load, it is both compressed and expanded in the radial direction, and the circumference tends to increase slightly, therefore the initial interference will decrease. The amount of decrease can be calculated with the following formula:

[ when  $Fr \leq 0.25 Cor$  ]

$$\Delta dF = 0.08 \sqrt{\frac{d}{B}} \cdot Fr \times 10 \dots\dots\dots (13)$$

[ when  $Fr > 0.25 Cor$  ]

$$\Delta dF = 0.02 \frac{Fr}{B} 10^{-3} \dots\dots\dots (14)$$

$\Delta dF$ : a mount of decrease of the interference, mm  
 d: bearing nominal bore diameter, mm  
 B: nominal bore width, mm  
 Fr: radial load, N { kgf }  
 Cor: basic static load rating, N { kgf }

Therefore, when the radial load is a heavy one ( exceeding the value of Co by 25%), the fit must be tighter than with light load.  
 If there is the shock load, the fit must be even tighter.

## (3) Effects of the fit surface roughness

When taking the plastic deformation of the fit surface into consideration, the effective interference after fit is influenced by the processing quality of the fit surface. It can be approximately expressed with the following formula:

[ ground shaft ]

$$\Delta d_{eff} = \frac{d}{d+2} \Delta d \dots\dots\dots (15)$$

[ turned shaft ]

$$\Delta d_{eff} = \frac{d}{d+3} \Delta d \dots\dots\dots (16)$$

$\Delta d_{eff}$ : effective interference, mm  
 $\Delta d$ : apparent interference, mm  
 d: bearing nominal inner diameter, mm

## (4) Effects of temperature

Generally speaking, the bearing temperature in operation is higher than the surrounding temperature, and if the bearing rotates with load, the temperature of the inner ring is higher than that of the shaft, and the heat expansion shall reduce the effective interference.

Now assume the temperature difference between that inside the bearing and the surrounding temperature of the housing is  $\Delta t$ , we can presume that the temperature difference between the inner ring and the shaft on the fit surface is approximately  $(0.10 \sim 0.15) \Delta t$ .

The reduced amount of interference caused by change is temperature can be calculated with the following formula:

$$\Delta dt = (0.10 \text{ to } 0.15) \Delta t \cdot \alpha \cdot d = 0.0015 \Delta t \cdot d \times 10 \dots\dots\dots (5)$$

$\Delta dt$ : reduced amount of the interference caused by the temperature difference, mm  
 $\Delta t$ : temperature difference between bearing inside and surrounding housing, °C  
 a: linear expansion factor of bearing steel,  $(12.5 \times 10^{-6})/^\circ\text{C}$   
 d: bearing nominal inner diameter, mm

Therefore, when the temperature of the bearing is higher than that of the shaft, the fit must be very tight.

On the other hand, the interference between the outer ring and housing may increase due to the temperature difference or linear expansion factor difference. Hence it must be noted when considering using the slide in the fit surface between the outer ring and the housing to adapt to the expansion.

## (5) The maximum stress inside the bearing caused by the fit

When mounting the bearing with interference fit, the rings sometimes may expand or contact, bringing about stress. If the stress is too big, the rings sometimes may break, to which attention must be paid.

The maximum stress inside the bearing caused by the fit can be calculated with the formula in Table2. As the reference value, it is safe to let the maximum interference not exceed 1/1000 of the shaft radius, or let the maximum stress  $\sigma$  not exceed 120MPa{12kgf/mm<sup>2</sup>}.

## (6) Others

When a much higher accuracy is required, the precision level of the shaft and housing should be increased. Compared with shaft, it is more difficult to process the housing and the precision level is low. Therefore, the loosened fit between the shaft and the housing is recommended.

When using hollow shaft or thin wall-thickness, the fit must be higher than normal.

When using two half housings, the fit with the outer ring must be loosened. For housing of cast aluminum or light alloy, the fit must be tighter than normal.

#### 4、Lubrication

Lubrication has important effects on the functions of the bearing. Whether the lubricant and the method are suitable or not shall influence the bearing life. That is to say, the lubrication is a necessary condition to assure the normal operation of bearing and the lubrication plays an important role in improving load-carry capability and service life of bearing.

##### 4.1 Purpose of lubrication

The purpose of bearing lubrication is to form a thin grease film on rolling or sliding surfaces in order to prevent the direct contact of the metals.

##### 4.2 The function of lubrication

Reducing the friction of metals and slow the wear.

The grease film formed expands the touching area and reduces the contacting stress.

Assure the rolling bearing can work normally under a high-frequency contact stress for a long time and elongates the bearing fatigue life.

Take away the heat generated by friction and reduce the temperature of bearing working surface in order to prevent burns.

Prevent the bearing from rust, dust and corrosion.

##### 4.3 Oil lubrication

Oil lubrication is applied to high-speed and heat-resistant bearings and is effective for reducing vibration and lowering noise.

Oil lubrication has the following methods:

###### (1) Oil drip lubrication

Oil drip lubrication can lubricate the bearing by dripping oil through the orifice of oil cup. The orifice of oil cup can be adjusted according to the magnitude of oil.

The advantage of lubrication method is the simple configuration and convenient use. But the viscosity degree of oil can not be too high. Or it can not go through smoothly and influence the lubrication effect.

###### (2) Oil bath lubrication

Oil bath lubrication also can be called soak oil lubrication. A part of bearing is dipped into the lubricant and make sure that every rollers can be dipped into the lubricant when rolling the bearing. Then the lubricant with rollers can go around other working parts of bearing. Considering the churning waste and increase of temperature, in order to slow down the aging speed of lubrication, oil bath lubrication should not be adopted when lubricating bearings with high rotate speed.

###### (3) Splash lubrication

Splash lubrication is often adopted when lubricating rolling bearing works in closed gearing. It splashes the lubricant using rotating parts, such as gear, swing oil plate and so on. The lubricant scatters on the bearing or flow into inside of

rolling bearing through a designed oil trough along the box wall to lubricate rolling bearing. The used lubricant can mass again in the box for recycling. Since splash lubrication doesn't need any other accessorial equipment, it is normally adopted by the gearing with simple and compact configuration. But the following three points should be paid more attention when using splash lubrication:

1) The upside surface of the lubricant should not be too high, or the wastage caused by churning oil will be overmuch. And it can also cause granule abrasion because of the sediment such as grinding scraps taken from oil pool to bearing part when churning oil. 2) The lubricant in the box should be often kept clean. Magnetism adsorber should be used in the oil pool to clear away grinding scraps and eyewinker for reducing granule abrasion.

3) When designing the configuration, a oil trough for storing and a throttle orifice towards bearing could be set up against box wall to make bearing in the similar situation where they are oil bath lubricated and dripping oil lubricated for supplying lubricant and preventing from the lack of oil.

##### (4) Oil cycling lubrication

Oil cycling lubrication is a way of actively lubricating for the part of rolling bearing. It pumps the lubricant from oil box using a lift pump and transmits the lubricant into the rolling bearing supporting through an oil pipe and oil bore. Then the lubricant returns to the oil box through the orifice of bearing housing for reusing after cooled and filtrated. Therefore, this method of lubrication can eliminate much more heat and simultaneously expel friction heat effectively. So it is applied to the bearing supporting with overload and high-speed rotation.

##### (5) Oil jet lubrication

Oil jet lubrication is a kind of oil circulating lubrication. But in order to make the lubricant adequately enter into the inside relative motion surface of high-speed bearing and synchronously avoid overheating and overmuch friction due to the circulatory superfluous oil under the condition of high-speed rotation, a nozzle is mounted against the oil orifice of bearing support and augment the stress of oil supply to spurt oil onto the bearing by dint of the nozzle for bearing lubrication and cooling. Thus, oil jet lubrication is a favorable lubrication method mainly adopted in rolling bearing with high-speed rotation. It is also the same with the situation where the dmn of rolling bearing exceeds 2000000mm<sup>2</sup>/r/min. The oil pump stress of oil jet lubrication is about 3-5 bar. For overcoming and avoiding clinging effect under the condition of high speed, what have to be done is to make sure that the speed of oil spurting from oil orifice is 20% larger than that of linear velocity of rolling bearing.

##### (6) Oil mist lubrication

Oil mist lubrication is a kind of micro-lubricating. It meets the lubricating demand of rolling bearing with a spot of lubricant. Oil mist lubrication is to lubricate bearing with the oil mist that converted from lubricating oil in the oil mist generator. Actually, rolling bearing still keep the status of sparse lubricating since oil mist coagulate into oil drippings on the working surface of rolling bearing. To avoid the overmuch of oil supplying and increase of rolling bearing's working temperature caused by the augment of friction inside the oil, oil mist lubrication is normally adopted when the linear velocity of roller is quite high. Generally, the stress of oil mist is around 0.05-0.1bar. But the following two points should be paid much attention when adopt this lubrication method:

1) The viscosity degree of lubricant should not exceed 340mm<sup>2</sup>/s (40°C) because exorbitant viscosity degree can not bring the effect of atomization.

2) The oil mist after lubricating may spread with air partially and result in environment pollution. The oil mist should be collected using oil-gas separator if necessary or eliminated by aerator.

##### (7) Oil air lubrication

Transmit little oil to the constringent airflow inside the pipe every third moment or so using stopcock ration distributor to form a continuous flowing of oil against the wall of the pipe for supplying to bearing. The oil won't aging because of

the new lubricant coming continuously. Compressing the air can make the impurity outside not to break into the inside of bearing easily. The little oil supplying can reduce the pollution to surrounding environment. Oil air lubrication use less oil than oil mist lubrication and has well stability, small friction moment, slowly temperature increasing. It is especially applied to high speed bearing.

#### 4.4 The selection principle of lubricant oil

From the invalidation instance of oil lubricated rolling bearing, we can see most of invalidations are caused by the low viscosity degree of lubricant. The lower viscosity degree of lubricant is, the smaller carrying capacity of oil film owns and the easier oil film break bringing that the metal material connect each other directly when doing relative motions inside the rolling bearing and leading the bearing life is shorted for the increase of friction and abrasion or the burn and rupture accident occurs. But if the viscosity degree is overmuch, it can cause the increase of friction. So the quantity of heat increases when churning the lubricant, that is to say, the consumed energy of the system will increase. On the other hand, for working under the condition of high-speed, high load and high temperature, the rolling bearing may have special demand of antirust, antioxidant, wearability and the increase of lubricant adsorbability. Therefore, for selecting lubricant, it is mainly to ensure the viscosity degree and additive kind or different lubricant with some additive.

The following is a general principle for selecting lubricant:

##### (1) Operating temperature

Operating temperature influences the viscosity degree of lubricant and the lubricating effect. So, when the operating temperature is lower, the low viscosity degree of lubricant should be selected; when the operating temperature is higher, the high viscosity degree of lubricant or the lubricant with proper additive should be selected. For the different temperature of surrounding, the viscosity degree of selected lubricant should varies synchronously. For example, much lower viscosity of degree lubricant should be selected when lubricating bearings in north area or winter than in south area or summer. When the operating temperature varies frequently, the lubricant with excellent viscosity temperature quality should be selected. Namely, the viscosity degree of lubricant doesn't change a lot when the operating temperature ascending or descending to ensure that the thickness of oil film is controlled in a certain range steadily.

##### (2) Motion Velocity

The higher rotation speed, the lower viscosity of lubricating oil should be selected, to avoid moving resistance and producing more heat. On the contrary, under the situation of the lower rotation speed, using the higher viscosity will be beneficial to improve the ability of load for bearings.

##### (3) Velocity Characteristic

In motion, there are pounding, vibration, frequent changes of load and speed, and starting. Stop motion, rolling back frequent and intercourse or intermittence moving, they are not beneficial to form the oil film. Sometimes, would rather adopt lubricating grease, even the solid lubricating, to make sure the reliable lubrication.

##### (4) Loading

The bigger load of rolling bearings, the higher viscosity, the better oiliness and extreme-pressure of lubricating oil should be selected, to avoid squeezing the lubricating oil from the friction pair, or producing the direct contact of metal

##### (5) Structure feature

The smaller roller bearing's radial clearance is, the higher friction surface's process precision, the lower the viscosity of oil lubrication.

##### (6) Circumstance condition

When the bearing works under the condition of moisture corrosive gas, lower temperature, dust, radiation, the oil lubrication is easy to be polluted. Choosing the oil lubrication has feature of wearability, anti-corrosion, cold-

resistant, anti-radiate. When the circumstance is water pollution, latex ejection, moisture or heavy dust, don't choose the oil lubrication but the grease lubrication.

##### (7) The precision of the bearing

When the friction surface is crudity, generally, the high viscosity of oil lubrication should be selected so that it can carry part pressure owing to the mal of contacting, but when the precision of motion friction is high, the low viscosity of lubricant should be chosen to reduce the unnecessary waste of energy and increase of temperature.

##### (8) Bearing hardness

When the hardness of bearing motion friction surface is low, the high viscosity degree of lubricant should be selected and the amount of oil should be rich. Contrarily, the viscosity degree of lubricant could be reduced.

## 5、Data of bearings

### 5.1 Main dimensions

The main dimensions of bearings indicate the boundary dimensions of inner ring, outer ring, width or height and chamfer and others that are used to describe the outline of the bearing. They are the necessary dimensions required for the mounting on the shaft or in the housing.

These main dimensions have been standardized by international standard (ISO15). GB307 (main dimensions for rolling bearings) are also based on ISO standards.

The national standards have defined the main dimensions. The details are provided in the bearing catalogue.

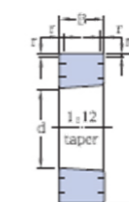

Radial bearing (Excluding tapered roller bearing)

d: bearing nominal bore diameter

D: bearing nominal outer diameter

B: bearing nominal width

r: inner and outer rings chamfer dimension

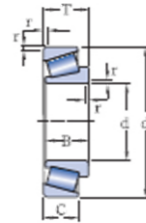

### Tapered roller bearing

- d: bearing nominal bore diameter
- D: bearing nominal outer diameter
- T: bearing nominal width (assembly width)
- B: inner ring nominal width
- C: outer ring nominal width
- r: inner and outer rings chamfer dimension

## 5.2 Bearing Precision

Rolling bearing precision class has been standardized and has been classified into 6 levels of P0, P6X, P6, P5, P4 and P2.

The precision level increases beginning from P0. P0 class is applicable for normal purpose. When bearings are working in special conditions or circumstances, P5 or even higher precision is needed. Although the above mentioned precision class is made on the ISO basis, it is named differently in some countries. Applicable precision classes to all kinds of bearing types and comparisons among different countries' standards are listed in below table.

Bearing type		Applicable standard	Applicable precision class					
Deep groove ball bearings		GB307	Class 0	—	Class 6	Class 5	Class 4	Class 2
Angular contact ball bearings			Class 0	—	Class 6	Class 5	Class 4	Class 2
Tapered roller bearings	Metric series (single row)	GB307 SB/T53419-94 SB/CO/T10-89	Class 0	Class6X	Class 6	Class 5	Class 4	—
	Metric series (double-row, four-row)		Class 0	—	—	—	—	—
	Inch series		Class4	—	Class2	Class3	Class0	Class00
Spherical Roller bearings		GB307	Class 0	—	—	—	—	—

- Dimension precision (relative to axle and housing mounting)
  - ▲ Bore diameter, outer diameter, width and permissible deviation of assembly width
  - ▲ Permissible deviation of roller group inner and outer inscribed circle diameters
  - ▲ Permissible limit value of chamfer dimension
  - ▲ Permissible variation of width
  - ▲ Permissible deviation and variation of tapered bore
- Rotation precision (relative to rotation object' s runout)
  - ▲ Permissible radial and axial runout of inner and ring and outer ring
  - ▲ Permissible horizontal runout of inner ring
  - ▲ Permissible variation of outer diameter surface leaning slop

## 5.3 clearance

If the amount of expansion or contraction of the rings caused by the interference fit when mounting the bearing on the shaft or in the housing is deducted from the theoretical clearance, then we have the "Mounting Clearance". Furthermore, if the dimensional changed caused by the temperature difference inside the bearing is added to or reduced from the mounting clearance, we have the so-called "Effective Clearance". When the bearing rotates while carrying a certain magnitude of load in the machine, if the elastic deformation caused by the load is added to the effective clearance, we then have the "Working Clearance".

As shown in Figure 2, when the working clearance is a slightly negative, the bearing has the longest service life. But with the negative clearance changing to be positive, the fatigue life shall decrease. Therefore, when choosing the clearance, it is preferred to choose the 0 or slightly positive working clearance.

As to table 2: The relations between the working clearance and the fatigue life.

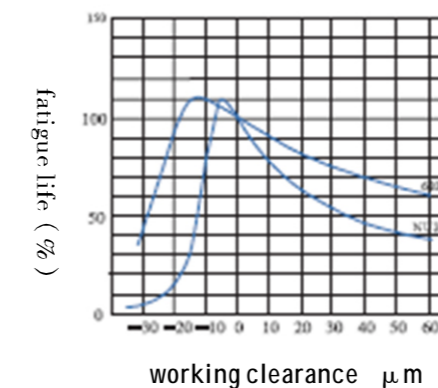

In addition, when a higher rigidity or a lower noise is required, a further negative working clearance is preferred, and when the temperature increases inside the bearing, a bigger positive value of the working clearance will be better. In these or many other cases, specific analyses should be made according to the application conditions.

The values of clearance of the bearings are shown in Table 1 ~ Table 4

Table1 Radial clearance of deep groove ball bearings (Cylindrical bore) μm

Nominal inner ring d mm		clearance									
		Group 2		Group 0		Group 3		Group 4		Group 5	
over	to	min	max	min	max	min	max	min	max	min	max
2.5	6	0	7	2	13	8	23	—	—	—	—
6	10	0	7	2	13	8	23	14	29	20	37
10	18	0	9	3	18	11	25	18	33	25	45
18	24	0	10	5	20	13	28	20	36	28	48
24	30	1	11	5	20	13	28	23	41	30	53
30	40	1	11	6	20	15	33	28	46	40	64
40	50	1	11	6	23	18	36	30	51	45	73
50	65	1	15	8	28	23	43	38	61	55	90
65	80	1	15	10	30	25	51	46	71	65	105
80	100	1	18	12	36	30	58	53	84	75	120
100	120	2	20	15	41	36	66	61	97	90	140
120	140	2	23	18	48	41	81	71	114	105	160
140	160	2	23	18	53	46	91	81	130	120	180
160	180	2	25	20	61	53	102	91	147	135	200
180	200	2	30	25	71	63	117	107	163	150	230
200	225	2	35	25	85	75	140	125	195	175	265
225	250	2	40	30	95	85	160	145	225	205	300
250	280	2	45	35	105	90	170	155	245	225	340
280	315	2	55	40	115	100	190	175	270	245	370
315	355	3	60	45	125	110	210	195	300	275	410
355	400	3	70	55	145	130	240	225	340	315	460
400	450	3	80	60	170	150	270	250	380	350	510
450	500	3	90	70	190	170	300	280	420	390	570
500	560	10	100	80	210	190	330	310	470	440	630
560	630	10	110	90	230	210	360	340	520	490	690
630	710	20	130	110	260	240	400	380	570	540	760
710	800	20	140	120	290	270	450	430	630	600	840
800	900	20	160	140	320	300	500	480	700	670	940
900	1000	20	170	150	350	330	550	530	770	740	1040
1000	1120	20	180	160	380	360	600	580	850	820	1150
1120	1250	20	190	170	410	390	650	630	920	890	1260

Table 2 Radial clearance of cylindrical roller bearing with cylindrical bore  $\mu\text{m}$

Nominal inner ring d mm		clearance									
		C2		standard		C3		C4		C5	
over	to	min	max	min	max	min	max	min	max	min	max
-	10	0	25	20	45	35	60	50	75	—	—
10	24	0	25	20	45	35	60	50	75	65	90
24	30	0	25	20	45	35	60	50	75	70	95
30	40	5	30	25	50	45	70	60	85	80	105
40	50	5	35	30	60	50	80	70	100	95	125
50	65	10	40	40	70	60	90	80	110	110	140
65	80	10	45	40	75	65	100	90	125	130	165
80	100	15	50	50	85	75	110	105	140	155	190
100	120	15	55	50	90	85	125	125	165	180	220
120	140	15	60	60	105	100	145	145	190	200	245
140	160	20	70	70	120	115	165	165	215	225	275
160	180	25	75	75	125	120	170	170	220	250	300
180	200	35	90	90	145	140	195	195	250	275	330
200	225	45	105	105	165	160	220	220	280	305	365
225	250	45	110	110	175	170	235	235	300	330	395
250	280	55	125	125	195	190	260	260	330	370	440
280	315	55	130	130	205	200	275	275	350	410	485
315	355	65	145	145	225	225	305	305	385	455	535
355	400	100	190	190	280	280	370	370	460	510	600
400	450	110	210	210	310	310	410	410	510	565	665
450	500	110	220	220	330	330	440	440	550	625	735

Table 3 Radial clearance of Self-aligning roller bearing with cylindrical bores  $\mu\text{m}$

Nominal inner ring d mm		clearance									
		Group 2		Group 0		Group 3		Group 4		Group 5	
over	to	min	max	min	max	min	max	min	max	min	max
14	18	10	20	20	35	35	45	45	60	60	75
18	24	10	20	20	35	35	45	45	60	60	75
24	30	15	25	25	40	40	55	55	75	75	95
30	40	15	30	30	45	45	60	60	80	80	100
40	50	20	35	35	55	55	75	75	100	100	125
50	65	20	40	40	65	65	90	90	120	120	150
65	80	30	50	50	80	80	110	110	145	145	180
80	100	35	60	60	100	100	135	135	180	180	225
100	120	40	75	75	120	120	160	160	210	210	260
120	140	50	95	95	145	145	190	190	240	240	300
140	160	60	110	110	170	170	220	220	280	280	350
160	180	65	120	120	180	180	240	240	310	310	390
180	200	70	130	130	200	200	260	260	340	340	430
200	225	80	140	140	220	220	290	290	380	380	470
225	250	90	150	150	240	240	320	320	420	420	520
250	280	100	170	170	260	260	350	350	460	460	570
280	315	110	190	190	280	280	370	370	500	500	630
315	355	120	200	200	310	310	410	410	550	550	690
355	400	130	220	220	340	340	450	450	600	600	750
400	450	140	240	240	370	370	500	500	660	660	820
450	500	140	260	260	410	410	550	550	720	720	900
500	560	150	280	280	440	440	600	600	780	780	1000
560	630	170	310	310	480	480	650	650	850	850	1100
630	710	190	350	350	530	530	700	700	920	920	1190
710	800	210	390	390	580	580	770	770	1010	1010	1300
800	900	230	430	430	650	650	860	860	1120	1120	1440
900	1000	260	480	480	710	710	930	930	1220	1220	1570

Table 4 Radial clearance of double row and four row tapered roller bearings  $\mu\text{m}$

Nominal inner ring d mm		clearance											
		Group 1		Group 2		Group 0		Group 3		Group 4		Group 5	
over	to	min	max	min	max	min	max	min	max	min	max	min	max
-	30	0	10	10	20	20	30	40	50	50	60	70	80
30	40	0	12	12	25	25	40	45	60	60	75	80	95
40	50	0	15	15	30	30	45	50	65	65	80	90	110
50	65	0	15	15	30	30	50	50	70	70	90	90	120
65	80	0	20	20	40	40	60	60	80	80	110	110	150
80	100	0	20	20	45	45	70	70	100	100	130	130	170
100	120	0	25	25	50	50	80	80	110	110	150	150	200
120	140	0	30	30	60	60	90	90	120	120	170	170	230
140	160	0	30	30	6	65	100	100	140	140	190	190	260
160	180	0	35	35	70	70	110	110	150	150	210	210	280
180	200	0	40	40	80	80	120	120	170	170	230	230	310
200	225	0	40	40	90	90	140	140	190	190	260	260	340
225	250	0	50	50	100	100	150	150	210	210	290	290	380
250	280	0	50	50	110	110	170	170	230	230	320	320	420
280	315	0	60	60	120	120	180	180	250	250	350	350	460
315	355	0	70	70	140	140	210	210	280	280	390	390	510
355	400	0	70	70	150	150	230	230	310	310	440	440	580
400	450	0	80	80	170	170	260	260	350	350	490	490	650
450	500	0	90	90	190	190	290	290	390	390	540	540	720
500	560	0	100	100	210	210	320	320	430	430	590	590	790
560	630	0	110	110	230	230	350	350	480	480	660	660	880
630	710	0	130	130	260	260	400	400	540	540	740	740	910
710	800	0	140	140	290	290	450	450	610	610	830	830	1100
800	900	0	160	160	330	330	500	500	670	670	920	920	1240
900	1000	0	180	180	360	360	540	540	720	720	980	980	1300
1000	1120	0	200	200	400	400	600	600	820				
1120	1250	0	220	220	450	450	670	670	900				
1250	1400	0	250	250	500	500	750	750	980				

## 6、 The system of bearing code

### 6.1 The basic bearing code

#### 6.1.1 The standard bearings

Each standard bearing, designed by ZWZ, has a basic code, which usually consists of three, four or five digitals, or combined with letters and digitals.

The meaning of digitals (or letters and digitals) is as below:

- The initial digital, letter or letter group indicates bearing type.
- The second and the third digital indicates the dimensional series. The second digital stands for the width (height) series, the third digital stands for the diameter series.
- The last two digitals of the basic bearing code multiplied by 5 will be the bore diameter in millimeter.

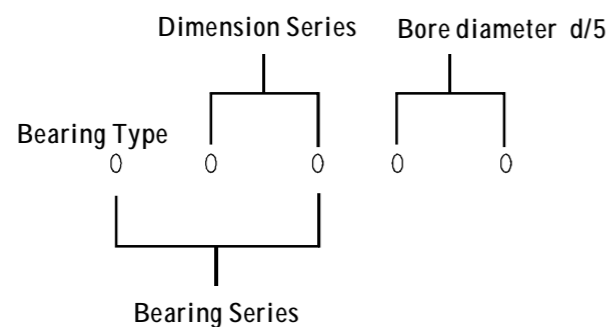

#### The code of bearing types

- 0- Double-row angular contact ball bearing
- 1- Self-aligning ball bearing
- 2- Self-aligning roller bearing and aligning roller thrust bearing
- 3- Tapered roller bearing
- 4- Double-row deep groove ball bearing
- 5- Thrust ball bearing
- 6- Deep groove ball bearing
- 7- Angular contact ball bearing
- 8- Cylindrical roller thrust bearing
- 9- Tapered roller thrust bearing
- N- Cylindrical roller bearing

If there are one or more letters followed "N", such as NJ, NU, NUP, the code will stand for rib types of the bearings.

NN stands for double-row or multi-row cylindrical roller bearing.

NA or NK is usually used to stand for Needle roller bearings.

U- Spherical outside surface ball bearing

QJ- Four-point contact ball bearing

Table 1 The series code of bearings in basic codes

Table 1 Bearing series code

Bearing type	Bearing series code	Type code	Dimensional series code
Single-row deep groove ball bearing	618	6	18
	619	6	19
	160	6	(0)0
	60	6	(1)0
	62	6	(0)2
	63	6	(0)3
Double-row deep groove ball bearing (with filling slot)	64	6	(0)4
	42	4	(2)2
Single-row angular contact ball bearing	43	4	(2)3
	719	7	19
	70	7	(1)0
	72	7	(0)2
Double-row angular contact ball bearing (with filling slot)	73	7	(0)3
	74	7	(0)4
	32	(0)	32
Four-point contact ball bearing	33	(0)	33
	QJ2	QJ1	(0)2
Self-aligning ball bearing	QJ3		(0)3
	12	1	(0)2
	22	(1)	22
	13	1	(0)
Single-row cylindrical roller bearing	23	(1)	23
	NU10	NU	10
	NU2	NU	(0)2
	NU22	NU	22
	NU32	NU	32
	NU3	NU	(0)3
Tapered roller bearing	NU23	NU	23
	NU4	NU	(0)4
	329	3	29
	320	3	20
	330	3	30
	331	3	31
	302	3	02

Table 2 ( Cotinued )

Bearing type	Bearing series code	Type code	Dimensional series code
Tapered roller bearing	322	3	22
	332	3	32
	303	3	03
	313	3	13
	323	3	23
Spherical roller bearing	239	2	39
	230	2	30
	240	2	40
	231	2	31
	241	2	41
	222	2	22
	232	2	32
	213	2	03
223	2	23	
Thrust ball bearing (single direction plane housing washer type)	511	5	11
	512	5	12
	513	5	13
	514	5	14
Thrust ball bearing (single direction aligning housing washer type)	532	5	32
	533	5	33
	534	5	34
Thrust ball bearing (double direction plane housing washer type)	522	5	22
	523	5	23
	524	5	24
Thrust ball bearing (double direction aligning housing washer type)	542	5	42
	543	5	43
	544	5	44
Thrust spherical roller bearing	292	2	92
	293	2	93
	294	2	94

[Note: ]

1 ) ( ) Width series code showed in bracket will be default in bearing series code

2 ) Cylindrical roller bearing includes NJ, NUP, N, NF and NH type besides NU type.

## 6.1.2 The non-standard bearings

The basic code of the non-standard bearing consists of two parts, one is the bearing type code and the other is bearing dimension code.

**Type code** Reference to the present ZWZ standard

**Dimensional code** Defined as following two methods

1. Non-standard bearing showed as dimensional series code

a) Standard bore diameter and non-standard outside diameter or width ( height )

The non-standard outside diameter or width (height) should be indicated by a letter following basic bearing code of a bearing, which has a most similar diameter series or width (height series) with this non-standard bearing. This bearing can be determined through comparing the standard OD dimension or width (height) dimension, or following the extensive rule of the standard boundary dimension. Please refer to Table 3.

Bearing type	Bearing basic code
Double row angular contact ball bearing	4600
Self-aligning ball bearing	1600
Spherical roller bearing	20600
Tapered roller bearing	30600
Double raceway outer ring - double row taper roller bearing	350600
Double raceway inner ring - double row taper roller bearing	370600
Four rows taper roller bearing	380600
Double-row deep groove ball bearing	40600
Thrust ball bearing	51700
Double direction thrust ball bearing	52700
Deep groove ball bearing	6600
Angular contact ball bearing	7600
Four point contact ball bearing ( double half inner ring )	QJ600
Four point contact ball bearing ( double half outer ring )	QJF600
Thrust angular contact ball bearing	561700
Double direction thrust angular contact ball bearing	232700
Thrust cylindrical roller bearing	81700
Double direction thrust cylindrical roller bearing	82700



Thrust tapered roller bearing	91700
Double direction thrust tapered roller bearing	92700
Cylindrical roller bearing	N600、NU600、NJ600、NF600 NUP600、NN600、NNU600
Thrust spherical roller bearing	21700

[Note]  
The "00" in above tables refers to any suitable inner diameter code.

b) Non-standard bore diameter, outside diameter and width  
The non-standard bore diameter, outside diameter and width (height) should be indicated by indefinite series code because the comparison with standard dimension or, extensive rule of the standard boundary dimension is not available.  
Please refer to Table 4 for the indefinite series code of ZWZ bearings.

Table 4

Letter	Meaning
X1	Non-standard outside diameter
X2	Non-standard width (height)
X3	Non-standard outside diameter and width (height) (Standard bore diameter)

## 2. Non-standard bearing indicated by bore diameter code

Table 5

Bore diameter	Indication method
Standard dimension	Reference to the present standard
Non-standard dimension	<p>Bore diameter is indicated by the quotient divided by 5 if this bore diameter is smaller than 500mm and can be divided by 5.</p> <p>Other bore diameter are indicated with the actual bore diameter value (mm) or additive letter. When the bore diameter value (mm) is integer or with one place decimal, it can be indicated with this dimension directly, but be separated from the dimension series code with "/" ;</p> <p>When the actual bore diameter value (mm) is with two or more places decimals, the dimension is indicated with the integral part and expressed with X4. For example, NCF6/27X4V, it indicates the cylindrical roller bearing, indefinite series, with the bore diameter of 27.762 and full filling with rollers.</p>

Example 1: 66/6.4 deep groove ball bearing, indefinite series, bore diameter is 6.4mm.

Example 2: 61936X1M deep groove ball bearing, non-standard outside diameter, close to diameter series 9.

Example 3: 62/14.5 deep groove ball bearing, dimension series 02, bore diameter is 14.5mm.

Example 4: 52706 double-direction ball thrust bearing, indefinite series, bore diameter is 30mm.

When the code names of several non-standard bearings, which belong to the same type but with the slightly different dimensions, are same with each other, they are distinguished by adding "-" and follow the sequence number 1, 2, 3..... after each code name.

For example, 61956X1M  
61956X1M-1

## 6.2 The illustration to the change of dimensions and structures

The suffix YA plus number indicates all technical changes. Please refer to the suffix illustration for details.

If one type of bearing has two changes on its structure, the bearing is indicated with YA plus two digitals. For example, /YA12, it indicates the surface of outer ring and inner bore of inner ring vary from the standard design. The specific change can be referenced to the product catalogue or the supplemented technical requirements.

If one type of bearing has two or more changes on its structure at the same time, the bearing is indicated with YAD.

## The specification to the change of the technical requirements

The suffix YB appended with digitals indicates all variations of the technical requirements. See more details to the specification of bearing suffix.

If one type of bearing has two changes on the technical requirements at the same time, the bearing is indicated with YB appended with two digitals. For example, /YB12, see the specific change to the product catalogue or supplemented technical requirements. If one type of bearing has two or more changes on its technical requirements, the bearing is indicated with /YBD.

If one type of bearing has changes both on the structure and the technical requirements at the same time, the bearing is indicated with /YAB.

Note: If the bearing suffix has Y and another letter or the appended number, it is suggested to reference the product catalogue or the supplemented technical requirements, in order to know the specific change.

### 6.2.1 Prefix code

Code	Meaning
N	Cylindrical roller bearing, inner ring with double ribs, outer ring without rib.
NCF	NF + snap ring
NCL	Cylindrical roller bearing, outer ring without rib but with double snap rings, inner ring with double ribs.
NF	Cylindrical roller bearing, inner ring with double ribs, outer ring with single rib.
NFP	Cylindrical roller bearing, inner ring with double ribs, outer ring with single rib and loose rib.

NJ	Cylindrical roller bearing, outer ring with double ribs, inner ring with single rib.
NJP	Cylindrical roller bearing, outer ring with double ribs, inner ring without rib but with loose rib.
NN	Double-row cylindrical roller bearing, inner ring with three ribs, outer ring without rib.
NNB	Double-row cylindrical roller bearing, both inner ring and outer ring without no rib.
NNCL	Double-row cylindrical roller bearing, inner ring with three ribs, outer ring without rib but with central spacer.
NNCF	Double-row cylindrical roller bearing, inner ring with three ribs, outer ring with single rib and with snap ring on the other side.
NND	Double-row cylindrical roller bearing, single inner ring, double outer rings with double ribs.
NNF	Double-row cylindrical roller bearing, double inner rings, single outer ring with central rib and no rib on both sides.
NNFP	Double-row cylindrical roller bearing, single inner ring, with loose ring on two sides, single outer ring with central rib and no rib on both sides.
NNJ	Double-row cylindrical roller bearing, outer ring with three ribs, inner ring with single rib.
NNP	Double-row cylindrical roller bearing, inner ring with no rib, outer ring with central rib and with loose rib on both faces.
NNU	Double-row cylindrical roller bearing, outer ring with three ribs, inner ring with no rib.
NU	Cylindrical roller bearing, outer ring with double ribs, inner ring without rib.
NUCL	Cylindrical roller bearing, inner ring with no rib but double snap rings
NUP	Cylindrical roller bearing, outer ring with double ribs, inner ring with single rib and loose rib.
T	complying with GB273.1 appendix A. For example, T 2ED 020 T- tapered roller bearing 2- angle series code (reference to GB273.1 appendix B) ED- series code (reference to GB273.1 appendix B) 020- inner ring 20mm

## 6.2.2 Suffix Code

code	meaning
-1, -2, ...	It indicates the non-standard series X1,X2,YA2,.....
A	1. Angular contact ball bearing, nominal contact angle $\alpha = 30^\circ$ 2. Tapered roller bearing, contact angle $\alpha$ and the outside diameter D1 not conform to the national standard, same as there are two or more $\alpha, D1$ which is different from the national standard in one

A	code, it will be indicated with A1, A2... by sequence. 3. Outer ring guided
AC	Angular contact ball bearing, nominal contact angle $\alpha = 25^\circ$
ACA	Aligning roller bearing with movable central rib and asymmetrical rollers.
A6	Inch tapered roller bearing, assembly of chamfer differed from TIMKEN, if the assembly of chamfer in one code have two or more bearings different from TIMKEN, it will be indicated with A61, A62...
B	1. Angular contact ball bearing, nominal contact angle $\alpha = 40^\circ$ 2. Tapered roller bearing, contact angle enlarged (enlarge with one more angle series) 3. Inner ring guided.
C	1. Angular contact ball bearing, nominal contact angle $\alpha = 15^\circ$ 2. Aligning roller bearing, inner ring with no rib but movable central rib, with symmetrical rollers, pressed steel cage. 3. Matched pair tapered roller bearing, when the axial clearance not complying with ZWZ standard, the mean value of the axial clearance should be directly added after C.
CA	Aligning roller bearing, inner ring with no rib but smaller ribs on both sides, filling with symmetrical rollers, solid brass cage.
/CM	Clearance of the electrical machine deep groove ball bearing.
/CN	0 group C clearances. /CN combined with the letter H, M or L, it indicates the clearance scope decreased in half; or combined with P, it indicates the clearance scope deviated. For example, /CNH 0 group clearance decreased in half, belonging to the upper part. /CNM 0 group clearance decreased in half, belonging to the middle part. /CNL 0 group clearance decreased in half, belonging to the low part. /CNP clearance scope lies in the upper part of 0 group clearance and the low part of C3 grade.
/C1	Clearance conforms to the standard group 1.
/C2	Clearance conforms to the standard group 2.
/C3	Clearance conforms to the standard group 3.
/C4	Clearance conforms to the standard group 4
/C5	Clearance conforms to the standard group 5.
	Letter H, M, L or P can follow directly after the clearance code, it indicates the clearance scope decreased in half or deviated, see explanation of /CN, but P must be added after the lower clearance grade. For example, /C3P clearance scope lies in the upper part of group C3 and the low part of grade C4.
/C9	Bearing clearance not conforms to the present standard. When two or more clearances in one code are different from the present standard, it will be indicated with the added digitals, such as C91, C92.....

/CR	When the matched pair tapered roller bearings have the radial clearance, the mean value of clearance will be added after CR.
D	1. Double row angular contact ball bearing, double inner ring, contact angle $\alpha = 45^\circ$ 2. Double row tapered roller bearing, no inner spacer or outer spacer, un-grinded end face. 3. Inch tapered roller bearing, inner ring with double raceway or outer ring with double raceway. 4. Split bearing.
/DB	Two single deep groove ball bearings or angular contact ball bearings or tapered roller bearings used for the back to back paired mounting.
/DC	Double row angular contact ball bearing with double outer ring.
/DF	Two single deep groove ball bearings or angular contact ball bearings or tapered roller bearings used for the face to face paired mounting.
/DT	Two single deep groove ball bearings or angular contact ball bearings or tapered roller bearings used for the same direction tandem paired mounting.
D1	Double row tapered roller bearing, with no inner spacer, grinded end face.
E	Inside design is changed, belonging to the reinforced type.
F	The materials of steel, nodular cast iron or power metallurgical solid cage are indicated with the added digitals. F1- carbon steel F2- graphite steel F3- nodular cast iron F4- powder metallurgy FA- steel, nodular cast iron or power metallurgical solid cage, outer ring guided. FAB- steel, nodular cast iron or power metallurgical solid cage, inner ring guided. FE- phosphated steel solid cage.
/HC	Ring and rolling elements or only ring or rolling elements are made from case hardened steel (/HC-20Cr2Ni4A; /HC1-20Cr2Mn2MoA; /HC2-15Mn).
/HE	Ring, rolling elements and cage or only the ring and rolling elements are made from electroslag remelting bearing steel (military first grade steel) ZGCr15.
/HG	Ring and rolling elements or only ring are made from other bearing steel (/HG-5GrMnMo; /HG1-55SiMoVA; /HG2-GCr18Mo; /HG3-42CrMo).
/HN	Ring and rolling elements are made from the heat resisting steel.
/HP	Ring and rolling elements are made from beryllium bronze or other anti-magnetic materials. When material is changed, it is indicated with the added digitals.
/HQ	Ring and rolling elements are made from the unusual materials (/HQ- plastic; /HQ1-ceramic alloy)
/HU	Ring, rolling elements and cage or only the ring and rolling elements are made from the unhardened stainless steel 1Cr18Ni9Ti.

/HV	Ring, rolling elements and cage or only the ring and rolling elements are made from the unhardened stainless steel
K	Tapered bore bearing. Conicity is 1: 12
K30	Tapered bore bearing. Conicity is 1: 30
L	Light alloy solid cage. When the material of cage is changed, it is indicated with the appended digitals.
L3	Zinky aluminum alloy ZnA127Cu2
LA	Light alloy solid cage, outer ring guided.
LB	Light alloy solid cage, inner ring guided.
M	Brass solid cage
MA	Brass solid cage, outer ring guided.
MB	Brass solid cage, inner ring guided.
N	Bearing with snap groove on outer ring.
/P0	Tolerance grade conforms to the standard P0, code is omitted.
/P6	Tolerance grade conforms to the standard P6
/P6X	Tolerance grade conforms to the standard P6X
/P5	Tolerance grade conforms to the standard P5
/P4	Tolerance grade conforms to the standard P4
/P2	Tolerance grade conforms to the standard P2
Q	Bronze solid cage, indicated with the appended digitals, which means different materials. Q1- aluminum iron manganese bronze. Q2- silicon iron zinc bronze. Q3- silicon nickel bronze. Q4- aluminum bronze. Q5- stannum bronze (ZQSn10-1)
/W20	Bearing with three lubricating oil holes on outer ring (no oil slot)
/W20A	Bearing with four lubricating oil holes on outer ring (no oil slot)
/W20C	Bearing with six lubricating oil holes on outer ring (no oil slot)
/W20T	Bearing with eight lubricating oil holes on outer ring (no oil slot)
/W23	Bearing with three lubricating oil holes on inner ring (no oil slot)

/W26	Bearing with six lubricating oil holes on inner ring.
/W33	Bearing with oil slot and three lubricating oil holes on outer ring.
/W33A	Bearing with oil slot and four lubricating oil holes on outer ring.
/W33X	Bearing with oil slot and six lubricating oil holes on outer ring.
/W513	W26+W33
/W518	W20+ W26
/W512	W23+ W33
/WN33	Bearing with oil groove and three lubricating oil holes on inner ring.
X1	Non-standard outside diameter.
X2	Non-standard width (height).
X3	Non standard outside diameter, width (height) (standard bore diameter)
/Y	<p>Y combines with another letter (such as YA, YB) or more digitals to identify the change of the non-series which can not be indicated with the present suffix code.</p> <p>YA- structure change</p> <p>YA1- outside surface of outer ring has change comparing to standard design.</p> <p>YA2- bore of inner ring has change comparing to the standard design.</p> <p>YA3- end face of bearing ring has change comparing to the standard design.</p> <p>YA4- raceway of bearing ring has change comparing to the standard design.</p> <p>YA5- bearing rolling elements have change comparing to the standard design.</p> <p>YAB- structure and technical specification have changes at the same time.</p> <p>YAD- one type of bearing has two or more changes on structure.</p> <p>YB- technical specification has change.</p> <p>YB1- surface of bearing ring has plated coating.</p> <p>YB2- bearing dimension and tolerance change.</p> <p>YB3- surface roughness of bearing ring change.</p> <p>YB4- heat treating specification (e.g. hardness) change.</p> <p>YB5- structure and position tolerance have special requirements.</p> <p>YBD- one type of bearing has two or more changes on technical specification.</p>

## Transmission Bearing Type Catalogue

# Deep Groove Ball Bearings

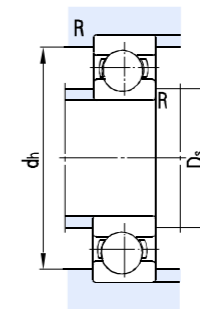
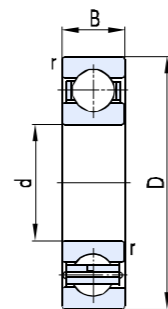
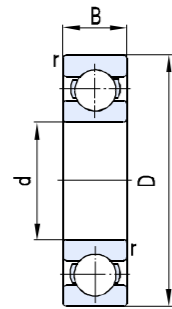

Basic dimensions				Basic load ratings		Limit speed		Designations	Abutment and fillet dimensions			Weight
d	D	B	rsmin	Cr	Cor	Grease	Oil		Dsmin	dhmax	Rmax	
mm				KN		r/min			mm			Kg
20	47	14	1	13.0	6.70	15000	18000	6204	25	42	1	0.110
	62	16	1	18.2	10.0	13000	16000	6304X3	28	54	1	0.252
22	56	16	1.1	17.7	9.25	12000	15000	63/22	29	47	1	0.183
23	56	15	1	18.5	9.30	12000	15000	66/23	29	47	1	0.125
25	42	9	0.3	9.50	4.55	15000	18000	61905	27	40	0.3	0.0415
	47	12	0.6	11.3	5.90	14000	17000	6005	29	43	0.6	0.078
	52	15	1	14.3	8.00	12000	15000	6205	30	47	1	0.134
	62	17	1.1	22.4	11.5	11000	14000	6305	31.5	55.5	1	0.214
	80	21	1.5	37.5	19.0	9000	11000	6405	33	72	1.5	0.530
28	68	18	1.1	23.5	13.0	9000	11000	63/28	34.5	61.5	1	0.299
30	47	9	0.3	9.75	4.95	14000	17000	61906	32	45	0.3	0.0433
	55	13	1	13.1	7.88	12000	15000	6006	34.6	50.4	1	0.121
	62	16	1	19.3	11.4	10000	13000	6206	35	57	1	0.218
	72	19	1.1	28.2	15.2	9000	11000	6306	36.5	65.5	1	0.354
	90	23	1.5	44.5	22.8	8500	10000	6406	38	82	1.5	0.805
33	72	17	1.1	22.5	13.6	9000	11000	62/33	38	66.5	1	0.308
35	47	7	0.3	4.92	3.00	13000	16000	61807	37	45	0.3	0.0292
	55	10	0.6	9.35	6.70	11000	14000	61907	38.2	51.8	0.6	0.0779
	62	14	1	16.3	10.5	10000	13000	6007	40	57	1	0.148
	72	17	1.1	25.7	15.3	9000	11000	6207	41.5	65.5	1	0.284
	80	21	1.5	35.5	19.2	8500	10000	6307	43	72	1.5	0.456
	100	25	1.5	55.5	29.5	7000	8500	6407	43	92	1.5	0.919
40	62	12	0.6	13.1	9.20	10000	13000	61908	43.2	58.8	0.6	0.108
	68	15	1	16.8	11.6	9500	12000	6008	44.6	63.4	1	0.191
	80	18	1.1	31.0	17.9	8500	10000	6208	46.5	73.5	1	0.361
	90	23	1.5	41.0	24.0	7500	9000	6308	48	82	1.5	0.642
	110	27	2	67.5	36.0	6700	8000	6408	49	101	2	1.20
41	80	17	1.1	31.0	19.0	8500	10000	62/41/HA	46.5	73.5	1	0.342

# Deep Groove Ball Bearings

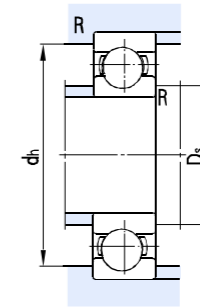
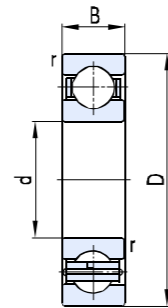
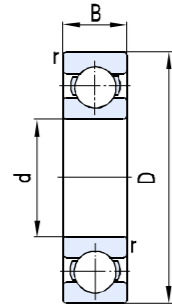

Basic dimensions				Basic load ratings		Limit speed		Designations	Abutment and fillet dimensions			Weight
d	D	B	rsmin	Cr	Cor	Grease	Oil		Dsmin	dhmax	Rmax	
mm				KN		r/min			mm			Kg
45	58	7	0.3	6.50	5.00	9500	12000	61809	47	56	0.3	0.0391
	75	16	1	21.0	14.0	9000	11000	6009	50	70	1	0.246
	85	19	1.1	33.3	20.4	7500	9000	6209	51.5	78.5	1	0.428
	100	25	1.5	52.7	30.0	6700	8000	6309	53	92	1.5	0.850
	120	29	2	78.0	46.0	6000	7000	6409	54	111	2	1.69
50	72	12	0.6	13.5	11.0	8500	10000	61910	53.2	68.8	0.6	0.134
	80	16	1	22.0	16.3	6500	10000	6010	55	75	1	0.248
	90	20	1.1	35.2	23.2	7100	8500	6210	56.5	83.5	1	0.504
	110	27	2	62.0	38.0	6300	7500	6310	59	101	2	1.07
	130	31	2.1	88.0	55.0	5300	6300	6410	61	119	2	1.85
55	72	9	0.3	8.80	8.10	8500	10000	61811	57	70	0.3	0.0845
	80	13	1	15.9	13.2	8000	9500	61911	59.6	75.4	1	0.177
	90	18	1.1	24.2	18.4	7500	9000	6011	61	84	1	0.384
	100	21	1.5	43.9	28.8	6300	7500	6211	63	92	1.5	0.605
	120	29	2	71.5	45.0	5600	6700	6311	64	111	2	1.39
	140	33	2.1	100	62.0	5000	6000	6411	66	129	2	2.31
60	85	13	1	17.0	15.1	7500	9000	61912	64.5	80.5	1	0.201
	95	18	1.1	30.0	23.0	6700	8000	6012	66.5	88.5	1	0.426
	110	22	1.5	53.0	33.0	5600	7100	6212	68	102	1.5	0.793
	130	31	2.1	82.0	48.5	5300	6300	6312	71	119	2	1.71
	150	35	2.1	109	70.0	4800	5600	6412	71	139	2	2.78
65	90	13	1	19.5	17.0	6700	8000	61913	70	85	1	0.203
	100	18	1.1	32.0	25.0	6300	7500	6013	71.5	93.5	1	0.428
	120	23	1.5	56.0	41.0	5300	6300	6213	73	112	1.5	0.973
	140	33	2.1	92.6	59.5	4800	5600	6313	76	129	2	2.10
	160	37	2.1	118	78.5	4500	6300	6413	76	149	2	3.25
70	110	20	1.1	38.0	31.0	6000	7000	6014	76.5	103.5	1	0.620
	125	24	1.5	60.5	46.0	5000	6000	6214	78	117	1.5	1.34
	150	35	2.1	105	68.0	4500	5300	6314	81	139	2	2.55
	180	42	3	143	103	3800	4500	6414	83	167	2.5	4.73
75	115	20	1.1	39.5	31.8	5600	6700	6015	81.5	108.5	1	0.630

# Deep Groove Ball Bearings

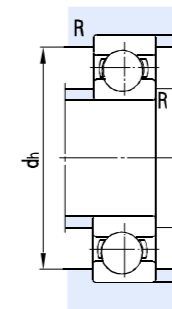
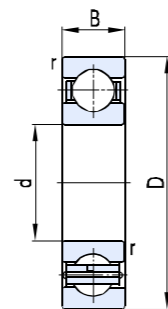
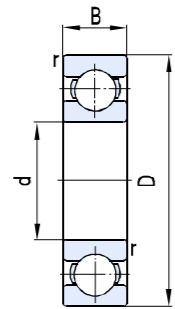

Basic dimensions				Basic load ratings		Limit speed		Designations	Abutment and fillet dimensions			Weight
d	D	B	rsmin	Cr	Cor	Grease	Oil		Dsmin	dhmax	Rmax	
mm				KN		r/min			mm			Kg
	130 160 190	25 37 45	1.5 2.1 3	66.0 113 153	50.0 77 114	4800 4300 3600	5600 5000 4300	6215 6315 6415	83 86 88	122 149 177	1.5 2 2.5	1.16 3.10 5.57
80	100 110 125 140 170 200	10 16 22 26 39 48	0.6 1 1.1 2 2.1 3	12.7 27.5 47.5 71.5 123 164	13.3 25.0 40.0 54.5 86.5 125	6000 5600 5300 4500 3800 3400	7000 6700 6300 5300 4500 4000	61816 61916 6016 6216 6316 6416	83.2 85 86.5 89 91 93	96.8 105 118.5 131 159 187	0.6 1 1 2 2 2.5	0.153 0.350 0.860 1.43 3.64 6.63
85	120 130 150 180 210	18 22 28 41 52	1.1 1.1 2 3 4	30.3 49.4 83.0 133 165	27.0 40.0 64.0 96.5 136	5300 5000 4300 3800 3200	6300 6000 5000 4500 3800	61917 6017 6217 6317 6417	91 91.5 94 98 101	114 123.5 141 167 194	1 1 2 2.5 3	0.557 0.935 1.80 4.33 8.12
90	125 140 160 190 225	18 24 30 43 54	1.1 1.5 2 3 4	33.0 58.5 96.0 144 193	31.5 50.0 72.0 108 158	5000 4800 3800 3400 3000	6000 5600 4500 4000 3600	61918 6018 6218 6318 6418	96.5 98 99 103 106	118.5 132 151 177 209	1 1.5 2 2.5 3	0.572 1.16 2.19 4.97 9.47
95	120 130 145 170 200 240	13 18 24 32 45 55	1 1.1 1.5 2.1 3 4	19.3 33.8 60.5 108 152 204	20.4 33.0 54.0 81.5 122 171	5000 4800 4500 3600 3200 3400	6000 5600 5300 4300 3800 3600	61819 61919 6019 6219 6319 6419M	99.6 101 103 106 108 108	115 124 137 159 187 215	1 1 1.5 2 2.5 2.5	0.288 0.610 1.14 2.61 5.65 13.4
100	125 140 150 180 180 215 250	13 20 24 28 34 47 58	1 1.1 1.5 1.8 2.1 3 4	19.6 40.2 60.5 116 122 173 224	21.2 39.0 56.5 92.0 93.0 141 195	4800 4500 4300 3400 3400 2800 2600	5600 5300 5000 4000 4000 3600 3400	61820 61920 6020 720 6220 6320 6420	105 106.5 108 111.5 111 113 116	120 133.5 142 171.5 169 202 234	1 1 1.5 1.8 2 2.5 3	0.326 0.850 1.17 2.70 3.20 7.01 12.8

# Deep Groove Ball Bearings

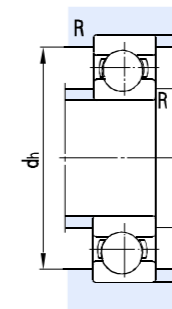
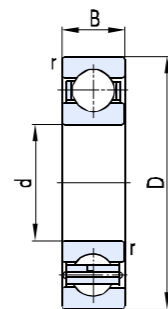
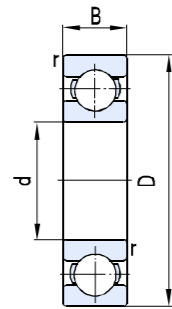

Basic dimensions				Basic load ratings		Limit speed		Designations	Abutment and fillet dimensions			Weight
d	D	B	rsmin	Cr	Cor	Grease	Oil		Dsmin	dhmax	Rmax	
mm				KN		r/min			mm			Kg
105	130	13	1	19.5	21.0	4500	5300	61821M	110	125	1	0.362
	160	26	2	73.0	65.5	4000	4800	6021	114	151	2	1.62
	180	22	1.1	68.0	65.0	4200	5000	721	113.5	173.5	1	2.61
	190	36	2.1	133	105	3200	3800	6221	116	179	2	3.66
	225	49	3	240	154	2800	3400	6321	118	212	2.5	7.84
110	140	16	1	26.7	28.0	4300	5000	61822	115	135	1	0.505
	150	20	1.1	43.5	44.5	4000	4800	61922	116.5	143.5	1	0.888
	170	28	2	82.0	73.5	3800	4500	6022	119	161	2	2.09
	200	38	2.1	144	112	2800	3400	6222	121	189	2	4.29
	240	50	3	205	176	2400	3000	6322	123	227	2.5	9.49
	280	65	4	265	226	2200	3000	6422	126	264	3	18.3
120	150	16	1	27.9	28.0	3800	4500	61824	125	145	1	0.568
	165	22	1.1	53.0	54.0	3600	4300	61924	126.5	158.5	1	1.21
	180	28	2	85.5	80.0	3400	4000	6024	129	171	2	2.21
	215	40	2.1	156	131	2800	3400	6224	131	204	2	5.26
	260	55	3	217	196	2200	2800	6324	133	247	2.5	12.2
130	165	18	1.1	35.8	38.0	3600	4300	61826MA	136	159	1	0.898
	180	24	1.5	65.0	67.0	3400	4000	61926	138	172	1.5	1.56
	200	33	2	106	95.0	3200	3800	6026	139	191	2	3.29
	230	40	3	165	148	2600	3200	6226	143	217	2.5	6.04
	280	58	4	250	239	2200	2600	6326	146	264	3	14.7
140	175	18	1.1	37.0	40.0	3400	4000	61828M	146.5	168.5	1	0.930
	190	24	1.5	64.0	67.5	3200	3800	61928M	148	182	1.5	2.11
	210	33	2	106	102	3000	3600	6028	146.5	201	2	3.25
	250	42	3	166	150	2400	3000	6228	153	237	2.5	7.41
	300	62	4	253	246	2000	2600	6328	156	284	3	18.5
150	190	20	1.1	46.4	53.0	3000	3600	61830M	156	184	1	1.36
	210	28	2	84.5	90	2800	3400	61930M	159	201	2	3.04
	225	35	2.1	123	117	2600	3200	6030	161	214	2	4.14
	270	45	3	175	169	2000	2600	6230	163	257	2.5	9.76
	320	65	4	277	280	1800	2200	6330	166	304	3	21.4



# Deep Groove Ball Bearings

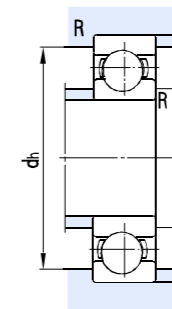
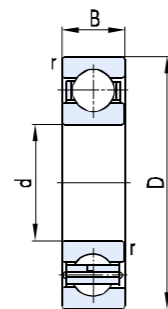
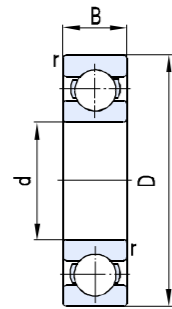

Basic dimensions				Basic load ratings		Limit speed		Designations	Abutment and fillet dimensions			Weight
d	D	B	r <sub>min</sub>	C <sub>r</sub>	C <sub>or</sub>	Grease	Oil		D <sub>smin</sub>	d <sub>hmax</sub>	R <sub>max</sub>	
mm				KN		r/min			mm			Kg
160	200	20	1.1	49.5	59	2600	3200	61832M	168	192	1.1	1.32
	220	28	2	87.5	90.0	2600	3200	61932M	169	211	2	3.28
	240	38	2.1	143	138	2400	3000	6032	171	229	2	5.63
	290	48	3	210	210	1900	2400	6232	173	277	2.5	12.3
	340	68	4	310	325	1800	2200	6332	177	323	3	25.7
170	215	22	1.1	65.0	61.0	2600	3200	61834M	176.5	208.5	1	1.87
	230	28	2	115	100	2400	3000	61934M	179	221	2	3.42
	260	42	2.1	170	171	2200	2800	6034	181	249	2	6.78
	310	52	4	227	240	1900	2400	6234	186	294	3	15.2
	360	72	4	330	368	1700	2000	6334	186	344	3	30.9
180	225	22	1.1	61.8	65.0	2400	3000	61836M	186	219	1	1.97
	250	33	2	127	137	2200	2800	61936M	189	241	2	5.27
	280	46	2.1	195	202	2200	2600	6036	191	269	2	8.83
	320	52	4	256	279	1800	2200	6236	196	304	3	15.4
	380	75	4	340	400	1700	1900	6336M	198	363	3	49.5
190	240	24	1.5	72.5	83.5	2200	2800	61838M	198	232	1.5	2.38
	260	33	2	127	138	2200	2800	61938M	199	251	2	5.85
	290	46	2.1	193	204	2000	2600	6038	201	279	2	9.58
	340	55	4	265	320	1700	2000	6238	206	324	3	18.9
	400	78	5	360	425	1600	1900	6338M	210	382	4	50
200	250	24	1.5	72.3	84.0	2200	2800	61840MA	207	243	1.5	2.68
	280	38	2.1	141	158	2000	2600	61940MA	210	270	2	7.63
	310	51	2.1	222	245	1900	2400	6040	211	299	2	11.7
	360	58	4	288	335	1700	2000	6240	216	344	3	22.6
220	270	24	1.5	74.0	105	1900	2400	61844M	227	263	1.5	3.21
	300	38	2.1	175	162	1900	2400	61944M	231	289	2	7.96
	340	56	3	245	293	1800	2200	6044	233	327	2.5	15.6
	400	65	4	297	365	1500	1800	6244	236	384	3	31.2
	460	88	5	403	520	1300	1600	6344	240	440	4	71.4
230	329.5	40	2.1	190	227	1600	2000	6646M	241	319	2.1	10.4

# Deep Groove Ball Bearings

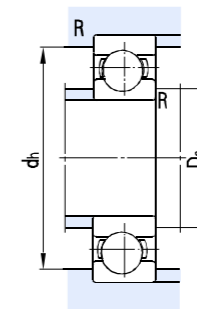
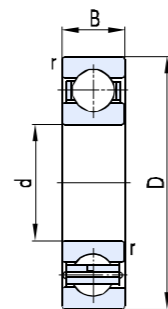
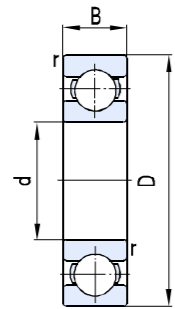

Basic dimensions				Basic load ratings		Limit speed		Designations	Abutment and fillet dimensions			Weight
d	D	B	rsmin	Cr	Cor	Grease	Oil		Dsmin	dhmax	Rmax	
mm				KN		r/min			mm			Kg
240	300	28	2	103	116	1800	2200	61848M	249	291	2	4.78
	320	38	2.1	155	186	1800	2200	61948M	251	309	2	8.10
	360	56	3	255	315	1700	2000	6048M	253	347	2.5	20.7
	440	72	4	360	470	1300	1600	6248	256	424	3	51.8
	500	95	5	440	595	1100	1400	6348M	260	480	4	96.2
260	320	28	2	122	128	1700	2000	61852M	269	311	2	4.85
	360	46	2.1	212	269	1600	1900	61952M	276	349	2	14.4
	400	65	4	294	375	1500	1800	6052M	276	384	3	28.8
	480	80	5	430	592	1100	1400	6252	280	460	4	68.8
	540	102	6	501	710	1000	1300	6352F1	286	514	5	120
280	350	33	2	131	188	1600	1900	61856M	289	341	2	7.17
	380	46	2.1	215	282	1500	1800	61956M	291	369	2	15.6
	420	65	4	305	405	1400	1700	6056	296	404	3	32.2
	500	80	5	410	600	1000	1300	6256	300	480	4	72
	580	108	6	560	840	1000	1200	6356	305	553	5	141
300	380	38	2.1	163	206	1400	1700	61860M	309	371	2	10.4
	420	56	3	267	370	1300	1600	61960	313	407	2.5	20.7
	460	74	4	340	480	1200	1500	6060	316	444	3	48.4
	540	85	5	450	665	950	1200	6260	320	520	4	88
320	400	38	2.1	164	220	1300	1600	61864M	331	389	2	11.4
	440	37	2.1	210	305	1200	1400	60964	331	428	2	15.5
	440	56	3	278	395	1300	1600	61964	333	427	2.5	24.9
	480	74	4	355	510	1100	1400	6064	336	464	3	50.3
	560	82	5	435	665	950	1200	6076F3	336	540	4	65.6
	580	92	5	515	780	900	1100	6264	340	560	4	111
340	420	38	2.1	169	227	1200	1500	61868	352	408	2	11.6
	460	56	3	282	420	1100	1400	61968	353	447	2.5	27.0
	520	82	5	403	620	950	1200	6068	360	500	4	63.4
	620	92	6	545	890	900	1000	6268	366	599	4	112
360	440	25	1.5	118	210	1130	1450	60872	367	432	1.5	6.5
	440	38	2.1	173	242	1100	1400	61872	351	429	2	12.2

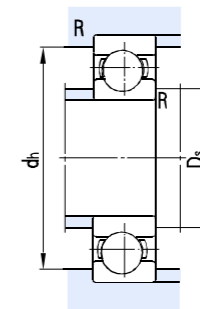
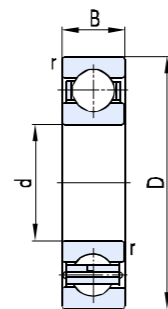
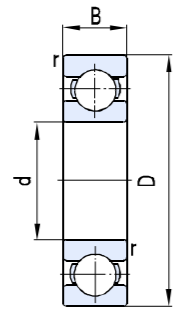

Basic dimensions				Basic load ratings		Limit speed		Designations	Abutment and fillet dimensions			Weight
d	D	B	rsmin	Cr	Cor	Grease	Oil		Dsmin	dhmax	Rmax	
mm				KN		r/min			mm			Kg
	480	56	3	282	425	1100	1400	61972	373	467	2.5	30.9
	540	82	5	439	698	1000	1200	6072M	380	520	4	65.7
380	480	46	2.1	278	345	1000	1300	61876F1	391	469	2	19.0
	520	65	4	345	550	1000	1300	61976	396	504	3	39.8
	560	82	5	439	665	950	1200	6076	398	542	4	69.3
400	500	31	2	159	277	1000	1200	60880	410	490	2	15
	500	46	2.1	242	403	1000	1200	61880	413	488	2	21
	540	44	3	258	435	980	1250	60980	411	525	2.5	27.5
	540	65	4	355	585	950	1200	61980	416	524	3	43.6
	600	90	5	495	780	900	1100	6080M	420	580	4	87.9
420	520	46	2.1	245	420	980	1250	61884	431	508	2	21.5
	620	90	5	495	875	900	1100	6084	437	603	4	90.5
440	540	31	2	155	285	900	1100	60888	450	531	2	16.5
	540	46	2.1	245	445	900	1100	61888	453	528	2	22
	600	50	4	305	550	900	1100	60988	456	585	3	41
	600	74	4	390	680	870	1000	61988	455	585	3	61.6
	650	94	6	525	880	850	1000	6088	466	624	5	108
460	580	56	3	303	435	900	1100	61892	473	567	2.5	34.3
	620	74	4	410	765	870	1100	61992	475	604	3	63
	680	100	6	553	945	800	950	6092F1	483	657	5	121
480	600	56	3	315	610	870	1100	61896	492	587	2.5	36
	650	78	5	417	743	800	950	61996F3	498	632	4	74.1
	700	100	6	605	1130	740	900	6096	504	676	5	126
500	620	37	2.1	220	445	800	950	608/500	510	609	2	20
	620	56	3	315	480	800	950	618/500M	513	607	2.5	37.3
	670	78	5	450	860	760	900	619/500	519	651	4	79
	720	100	6	575	1020	750	900	60/500	526	694	5	135
530	650	56	3	315	620	750	900	618/530F1	543	637	2.5	41.1
	650	56	3	315	620	750	900	618/530MA	543	637	2.5	42.1

# Deep Groove Ball Bearings

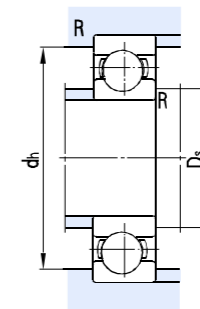
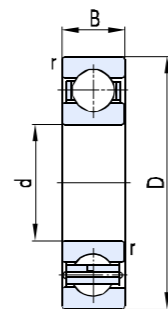
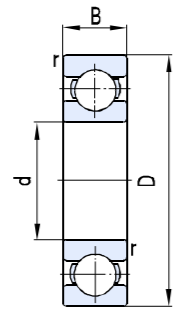

Basic dimensions				Basic load ratings		Limit speed		Designations	Abutment and fillet dimensions			Weight
d	D	B	rsmin	Cr	Cor	Grease	Oil		Dsmin	dhmax	Rmax	
mm				KN		r/min			mm			Kg
	710	57	4	410	810	690	840	609/530	545	696	3	60
	710	82	5	468	885	700	850	619/530F1	548	692	4	91.6
	780	112	6	635	1260	670	810	60/530	552	757	5	188
560	680	37	2.1	220	460	710	860	608/560	572	670	2	30
	680	56	3	328	525	700	850	618/560	573	667	2.5	42.8
	750	85	5	475	925	670	800	619/560F1	578	732	4	110
	820	115	6	670	1370	630	750	60/560F3	586	794	5	75.7
600	700	100	3	345	710	670	800	D66/600	610	690	2.5	60.6
	730	42	3	260	550	670	800	608/600	614	718	2.5	41
	730	60	3	345	710	670	800	618/600	614	717	2.5	52.7
	870	118	6	680	1450	600	700	60/600	623	847	5	233
630	780	48	3	355	730	640	760	608/630	643	767	2.5	41
	780	69	4	420	760	630	750	618/630	645	765	3	76.5
	850	71	5	475	1050	600	710	609/630	649	832	4	112
	850	100	6	610	1330	600	710	619/630	654	829	5	163
	920	128	7.5	800	1750	550	660	60/630	657	891	6	280
670	820	69	4	420	780	560	670	618/670	685	805	3	82.2
	900	73	5	540	1210	580	700	609/670	689	882	4	143
	900	103	6	670	1450	530	630	619/670MA	693	877	5	194
	920	118	6	750	1600	530	630	66/650N1	673	897	5	254
	980	136	7.5	904	1900	500	600	60/670F3	698	952	6	361
710	870	74	4	451	905	530	630	618/710	725	855	3	98.1
	950	78	5	545	1280	500	610	609/710	729	932	4	148
	950	106	6	645	1510	500	610	619/710	732	928	5	218
	1030	140	7.5	935	2180	490	560	60/710	738	1002	6	375
750	920	78	5	515	1240	480	610	618/750	766	901	4	110
	1000	112	6	745	1790	490	570	619/750	774	977	5	260
	1090	150	7.5	975	2370	450	530	60/750	778	1061	6	490
800	980	57	4	390	990	430	510	608/800	815	966	3	100
	980	82	5	545	1360	430	510	618/800	820	960	4	132

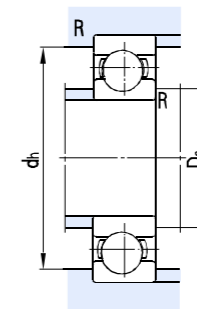
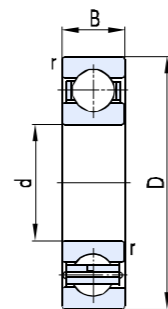
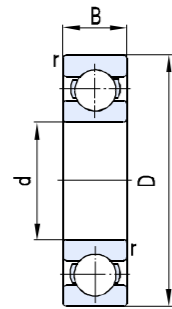

Basic dimensions				Basic load ratings		Limit speed		Designations	Abutment and fillet dimensions			Weight
d	D	B	rsmin	Cr	Cor	Grease	Oil		Dsmin	dhmax	Rmax	
mm				KN		r/min			mm			Kg
	1060	115	6	815	2100	430	500	619/800	823	1037	5	280
	1150	155	7.5	985	2530	400	480	60/800	828	1120	6	540
850	1030	57	4	385	1000	450	500	608/850	865	1015	3	75
	1030	82	5	555	1310	450	530	618/850	870	1010	4	144
	1120	118	6	815	2150	400	480	619/850	873	1098	5	315
	1220	165	7.5	1090	2980	370	430	60/850	879	1190	6	640
900	1090	85	5	600	1430	380	450	618/900F3	918	1072	4	155
	1180	122	6	830	2270	360	440	619/900	923	1156	5	355
	1280	170	7.5	1080	3120	330	410	60/900	928	1252	6	725
950	1150	90	5	660	1620	360	430	618/950F1	968	1132	4	188
	1250	132	7.5	985	2850	330	410	619/950	979	1222	6	395
	1360	180	7.5	1145	3315	310	380	60/950	979	1330	6	850
960	1160	90	5	630	1550	360	430	66/960MA	978	1142	4	199
1000	1220	71	5	540	1550	350	400	608/1000	1018	1201	4	175
	1220	100	6	680	1720	340	400	618/1000MA	1023	1197	5	234
	1320	103	6	800	2340	330	380	609/1000	1023	1297	5	405
	1320	140	7.5	985	2880	330	380	619/1000	1028	1292	6	525

# Single Row Cylindrical Roller Bearings

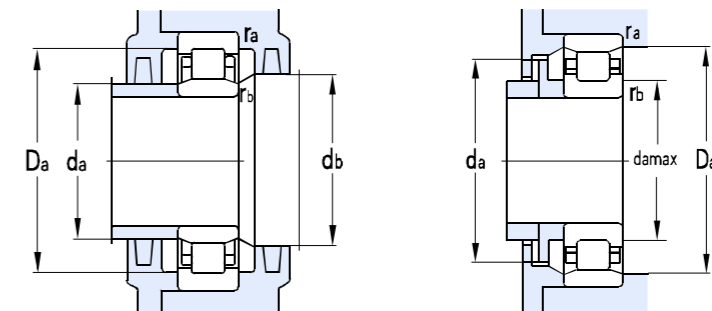
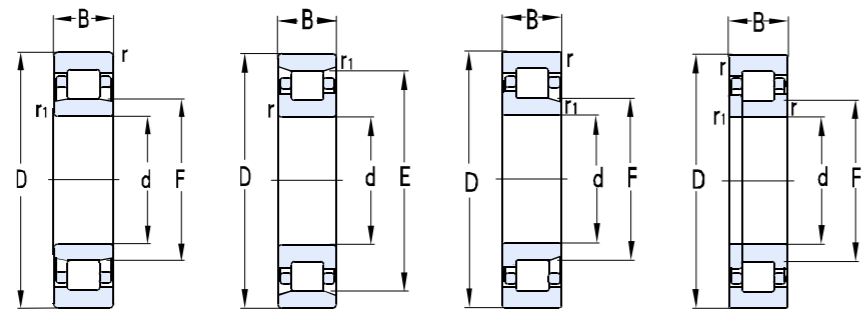

Basic dimensions							Basic load ratings		Limit speed		Designations	Abutment and fillet dimensions						Weight	
d	D	B	rsmin	r1smin	F	E	Cr	Cor	Grease	Oil		da min	da max	db min	Da max	Da max	ra max		rb max
mm							KN		r/min			mm						Kg	
25	52	15	1	0.6	31.5		28.6	24.0	11000	14000	NU205EM	29	30	36	47		1	0.7	0.159
	62	17	1.1	1.1	34		44.2	37.0	9500	12000	NJ305M	31.5	32	40	55.5		1	1	0.267
	62	24	1.1	1.1	35		53.4	52	9500	12000	NJ2305M/HA	31.5	32	40	55.5		1	1	0.453
30	55	13	1	0.6	36.5		18.2	18	12000	15000	NU1006M	34	35	38	50		1	0.6	0.138
	62	16	1	0.6	37.5		37.4	35.0	9500	12000	NJ206EM	34	36	43	57		1	0.6	0.264
	62	20	1	0.6	37.5		46.2	70.5	9500	12000	NJ2206EM	34	36	43	57		1	0.6	0.297
	72	19	1.1	1.1	40.5		53.3	51.0	9000	11000	N306M	36.5	39	47	65.5		1	1	0.403
	72	27	1.1	1.1	42		72.6	74	9000	11000	NUP2306M	36.5		47	65.5		1	1	0.585
	72	27	1.1	1.1	40.5		72.6	75.0	8000	9500	NU2306EM	36.5		47	65.5		1	1	0.593
	90	23	1.5	1.5	45		77.6	65.5	7500	9000	NJ406M	38	43	52	82		1.5	1.5	0.882
35	62	14	1	0.6	42		39.9	36.5	9000	11000	NU1007M	38.2	41	44	56		1	0.6	0.173
	72	17	0.6	1.1		64	53.2	46.5	8500	10000	N207EM	41.5	62		68	66	1	0.6	0.331
	72	23	1.1	1.1	44		66.1	59	8500	10000	NJ2207EM	39	42	50	65.5		1	0.6	0.363
	80	21	1.5	1.5		70.2	57.0	60.0	8000	9500	N307M	41.5	44		73.5	72	1.5	1	0.595
	80	21	1.5	1.1	46.2		71.3	70.0	8000	9500	NJ307EM	41.5	44	48	72		1.5	1	0.604
	80	31	1.5	1.5	46.2		77.0	80.0	7000	8500	NJ2307M	41.5	44	53	72		1.5	1	0.833
	80	31	1.1	1.1	46.2		101	100	7000	8500	NU2307EM	41.5	44	48	72		1.5	1	0.81
	100	25	1.5	1.5	53		89	85	6700	8000	NJ407M	44	49	59	85		1.5	1.5	1.10
40	68	15	1	0.6	47		26.4	28.0	9500	12000	NU1008M	42	45	50	65		1	0.6	0.231
	80	18	1.1	1.1		71.5	55.6	55.5	7500	9000	N208EM	46.5	69		73.5	73	1	1	0.425
	80	23	1.1	1.1	49.5		77.5	77.0	7500	9000	NJ2208EM	46.5	48	56	73.5		1	1	0.539
	90	23	1.5	1.5		80	88.0	87.0	6700	8000	N308EM	48	78		82	82	1.5	1.5	0.794
	90	33	1.5	1.5	52		122	116	6300	7500	NU2308EM	48	49	55	82		1.5	1.5	1.01
45	85	19	1.1	1.1	55		67.5	72.5	6700	8000	NJ209M	51.5	53	61	78.5		1	1	0.487
	85	19	1.1	1.1	54.5		67.5	72.5	6700	8000	NJ209EM	51.5	53	61	78.5		1	1	0.51
	85	23	1.1	1.1	54.5		80.8	84.5	5600	6700	NU2209EM	51	53	58	79		1	1	0.635
	100	25	1.5	1.5		86.5	106	109	6300	7500	N309M	53	58		92	90.5	1.5	1.5	0.920
	100	25	1.5	1.5		88.5	106	109	6300	7500	N309EM	53	86		92	91	1.5	1.5	0.959
	100	36	1.5	1.5	58.5		152	164	5600	6700	NJ2309EM	53	56	67	92		1.5	1.5	1.52
	120	29	2	2		100.5	124	123	5600	6700	N409M	54	97		111	103	2	2	1.67
50	80	16	1	0.6	57.5		44.5	53.2	8500	10000	NJ1010M	54	56	60	75		1	0.6	0.316
	90	20	1.1	1.1		80.4	57.0	64.0	6300	7500	N210M	56.5	79		83.5	82	1	1	0.559

# Single Row Cylindrical Roller Bearings

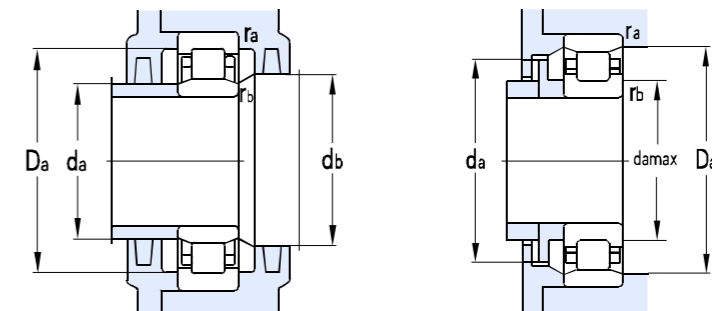
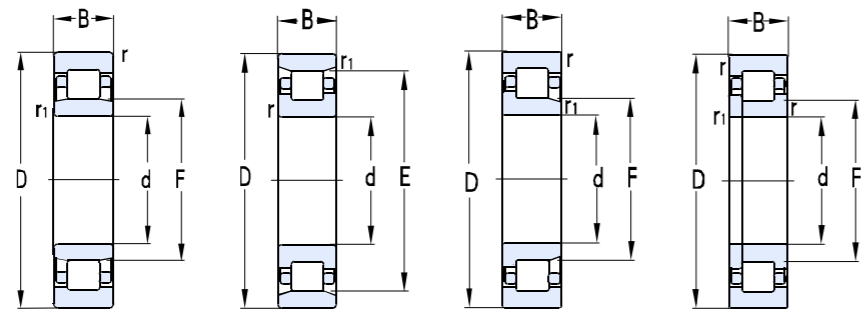

Basic dimensions							Basic load ratings		Limit speed		Designations	Abutment and fillet dimensions						Weight	
d	D	B	rsmin	r1smin	F	E	Cr	Cor	Grease	Oil		da min	da max	db min	Da max	Da max	ra max		rb max
mm							KN		r/min			mm						Kg	
	90	20	1.1	1.1		81.5	62.5	67.5	6300	7500	N210EM	56.5	79		83.5	82	1	1	0.566
	90	23	1.1	1.1	59.5		86.1	90	6300	7500	NU2210EM	56.5	57	62	83.5		1	1	0.65
	110	27	2	2		95	94.0	97.0	5000	6000	N310M	59	93		101	97	2	2	1.17
	110	27	2	2		97	121	125	5000	6000	N310EM	59	95		101	99	2	2	1.30
	110	40	2	2	65		150	170	5000	6000	NU2310M	59	61	67	101		2	2	1.91
	110	40	2	2	65		177	198	5000	6000	NJ2310EM	59	62	73	101		2	2	1.92
	130	31	2.1	2.1		110	151	151	5000	6000	N410M	61	107		119	113	2	2	2.18
55	90	18	1.1	1	64.5		54.4	66	7000	8500	NU1011M	59.6	63	67	84		1	1	0.479
	100	21	1.5	1.5		88.5	73.2	84.5	6000	7000	NF211M	63			93.5	92	1.5	1.5	0.806
	100	21	1.5	1.5		90	91.7	106	6000	7000	NF211E	63			93.5	92	1.5	1.5	0.757
	100	25	1.5	1.1	66		108	122	6000	7000	NJ2211EM	61.5	64	73	92		1.5	1	0.783
	120	29	2	2		104.5	148	136	4800	5600	N311M	64	102		111	107	2	2	1.65
	120	29	2	2		106.5	148	144	4800	5600	N311EM	64	104		111	109	2	2	1.60
	100	33.3	1.5	1.1		88.9	73.7	85.0	6000	7000	N3211M	63	87		93.5	92	1.5	1	1.20
	120	43	2	2	70.5		156	174	4800	5600	NU2311M	64	68	73	111		2	2	2.43
	120	43	2	2		106.5	220	246	4800	5600	N2311E	64	104		111	110	2	2	2.56
	140	33	2.1	2.1		117.2	162	168	4800	5600	N411M	66	114		129	119	2	2	2.86
60	95	18	1.1	1		85.5	50.6	66.0	6700	8000	N1012M	65	83		88.5	87	1	1	0.432
	110	22	1.5	1.5		100	103	102	5300	6300	N212EM	65	70		102		1.5	1.5	0.910
	110	22	1.5	1.5		97.5	80.5	92.5	5300	6300	N212M	68			102		1.5	1.5	0.937
	110	28	1.5	1.5	73.5		91.3	131	5300	6300	NUP2212M	68		80	102		1.5	1.5	1.27
	110	28	1.5	1.5	72		139	145	5300	6300	NJ2212EM	68	70	80	102		1.5	1.5	1.23
	130	31	2.1	2.1		113	163	152	4300	5000	N312M	71	110		119	116	2	2	2.04
	130	31	2.1	2.1		115	163	166	4300	5000	N312EM	71	112		119	118	2	2	2.06
	130	46	2.1	2.1		113	190	217	4300	5000	N2312M	71	110		119	117	2	2	2.95
	130	46	2.1	2.1		115	247	279	4300	5000	N2312E	71	112		119	118	2	2	2.93
	140	51	2.5	2.5		122	268	310	4300	5000	N612M	72	119		128	125	2	2	3.96
	150	35	2.1	2.1		127	193	202	4300	5000	N412M	71	124		139	130	2	2	3.29
65	120	23	1.5	1.5		105.6	109	125	4800	5600	N213M	73	103		112	111	1.5	1.5	1.11
	120	23	1.5	1.5		108.5	118	133	4800	5600	NF213EM	73	80		112	111	1.5	1.5	1.19
	120	31	1.5	1.5	79.6		122	154	4800	5600	NU2213M	73	76	81	112		1.5	1.5	1.65
	120	31	1.5	1.5	78.5		150	182	4800	5600	NU2213EM	73	76	81	112		1.5	1.5	1.61
	140	33	2.1	2.1		121.5	151	168	4000	4800	N313M	76	119		129	124	2	2	2.45
	140	33	2.1	2.1		124.5	201	185	4000	4800	N313EM	76	122		129	127	2	2	2.42

# Single Row Cylindrical Roller Bearings

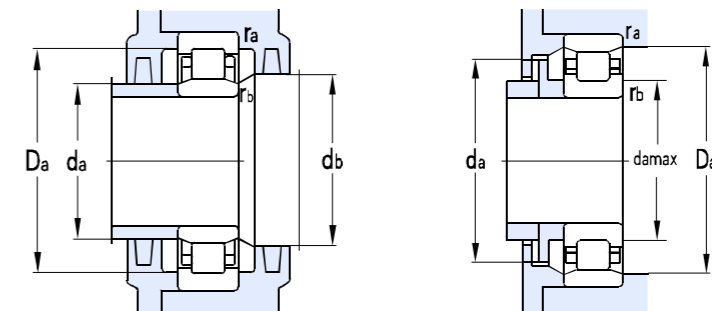
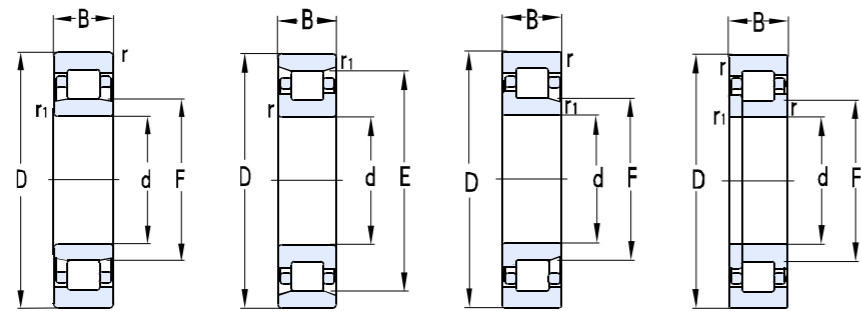

Basic dimensions							Basic load ratings		Limit speed		Designations	Abutment and fillet dimensions						Weight	
d	D	B	rsmin	r1smin	F	E	Cr	Cor	Grease	Oil		da min	da max	db min	Da max	Da max	ra max		rb max
mm							KN		r/min			mm						Kg	
	140	48	2.1	2.1	83.5		271	276	4000	4800	NU2313M	76	79	85	129				3.60
	140	48	2.1	2.1		124.5	271	305	4000	4800	NF2313E	76			129	127	2	2	3.60
	160	37	2.1	2.1		135.5	209	222	4000	4800	N413M	76	132		149	139	2	2	4.01
70	125	24	1.5	1.5		110.5	110	130	4500	5300	N214M	78	108		117	116	1.5	1.5	1.27
	125	24	1.5	1.5		113.5	130	152	4500	5300	N214E	78	111		117	116	1.5	1.5	1.29
	125	31	1.5	1.5		110.5	171	183	4500	5300	N2214M	78	81		117	100	1.5	1.5	1.68
	150	35	2.1	2.1		130	210	216	3600	4300	N314M	81	127		139	133	2	2	3.00
	150	35	2.1	2.1		133	224	242	3600	4300	N314EM	81	130		139	136	2	2	3.08
	150	35	2.1	2.1	89		224	226	3600	4300	NU314EM	82	86	91	138		2	2	3.45
	150	51	2.1	2.1	90		299	345	3600	4300	NU2314M	81	86	93	139		2	2	4.52
	150	51	2.1	2.1		133	299	345	3600	4300	N2314E	81	130		139	136	2	2	4.27
	180	42	3	3		151	262	283	3600	4300	N414M	83	148		167	155	2.5	2.5	5.66
	180	42	3	3		152	262	283	3600	4300	N414	83	148		167	155	2.5	2.5	6.40
	180	42	3	3	99		262	283	3600	4300	NU414M	83	97	102	167		2.5	2.5	5.79
180	42	3	3	100		262	283	3600	4300	NJ414M	83	97	113	167		2.5	2.5	5.94	
75	115	20	1.1	1	85		64.9	83.0	5600	6700	NU1015M	80	83	87	108.5		1	1	0.739
	130	25	1.5	1.5		116.5	130	148	4500	5300	N215M	83	114		122	121	1.5	1.5	1.40
	130	25	1.5	1.5		118.5	142	173	4500	5300	N215E	83	116		122	121	1.5	1.5	1.38
	130	31	1.5	1.5	88.5		177	197	4500	5300	NU2215M	83	86	91	122		1.5	1.5	1.75
	130	31	1.5	1.5		116.5	177	197	4500	5300	N2215M	83	86		122	121	1.5	1.5	1.77
	160	37	2.1	2.1	95		266	285	3400	4000	NU315EM	86	92	97	149		2	2	3.62
	160	37	2.1	2.1		143	266	285	3400	4000	N315E	86	140		149	146	2	2	3.59
	160	37	2.1	2.1		139.5	240	252	3400	4000	N315M	86	140		149	146	2	2	3.59
	160	37	2.1	2.1	95.5		240	252	3400	4000	NU315M	86	92	97	149		2	2	3.56
	160	55	2.1	2.1	95.5		361	345	3400	4000	NJ2315M	86	91	107	149		2	2	5.86
	190	45	3	3		160.5	300	325	3400	4000	N415M	88	101		177		2.5	2.5	6.86
80	125	22	1.1	1		113.5	78.1	100	5300	6300	N1016M	85	110		118.5	116.5	1	1	1.00
	140	26	2	2		125	140	158	4000	4800	N216M	89	123		131	128	2	2	1.66
	140	26	2	2		127.3	152	184	4000	4800	N216E	89	125		131	130	2	2	1.67
	140	33	2	2	95.3		190	233	4000	4800	NU2216M	89	93	98	131		2	2	2.32
	140	33	2	2		127.3	201	260	4000	4800	N2216E	89	124		131	130	2	2	2.16
	170	39	2.1	2.1		151	260	275	3200	3800	N316M	91	144		159		2	2	4.30
	140	44.5	2	2	95.28		217	305	4000	4800	NU5216	88	93	97	132		1.5	1.5	3.03
	170	58	2.1	2.1		147	394	420	3200	3800	N2316M	91	144		159		2	2	6.15



# Single Row Cylindrical Roller Bearings

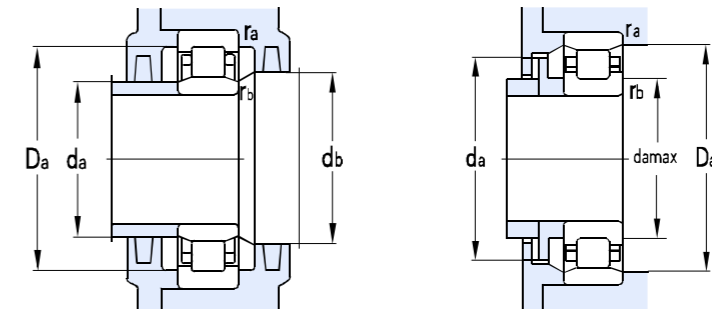
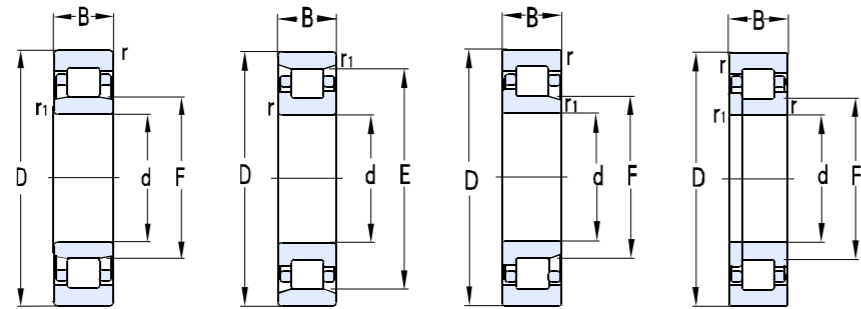

Basic dimensions							Basic load ratings		Limit speed		Designations	Abutment and fillet dimensions						Weight	
d	D	B	rsmin	r1smin	F	E	Cr	Cor	Grease	Oil		da min	da max	db min	Da max	Da max	ra max		rb max
mm							KN		r/min			mm						Kg	
	170	58	2.1	2.1	101	170	394	435	3200	3800	NJ2316EM N416M	91	98	113	159		2	2	6.62
	200	48	3	3			341	375	3200	3800		93	167		187		2.5	2.5	
85	150	28	2	2	101.8	133.8	165	191	3800	4500	N217M	94	132		141	139	2	2	2.08
	150	28	2	2		136.5	181	217	3800	4500	N217E	94	134		141	139	2	2	2.08
	150	36	2	2		238	266	3800	4500	NU2217M	94	98	103	141		2	2	2.8	
	150	36	2	2		100.5	238	279	3800	4500	NU2217EM	94	98	103	141		2	2	2.82
	180	41	1.1	1.1		108	323	360	3000	3600	NJ317EM	98	105	111	167		2.5	2.5	5.27
	150	49.2	2	2		102	223	310	3800	4500	NU3217M	94	98	103	141		2	2	3.88
	180	60	3	3		108	415	467	3000	3600	NJ2317M	96	103	120	169		2.5	2.5	7.81
	210	52	4	4		179.5	385	425	3000	3600	N417M	101	176		194	183	3	3	9.48
90	140	24	1.5	1.1	103	90	114	3600	4300	NJ1018M	96.5	101	106	132		1.5	1	1.38	
	160	30	2	2	143	162	209	3600	4300	N218M	99	140		151	148	2	2	2.64	
	160	30	2	2	145	198	241	3600	4300	N218E	99	142		151	148	2	2	2.49	
	160	40	2	2	143	235	299	3600	4300	N2218M	99	105		158	151	2	2	3.62	
	160	40	2	2	107	266	335	3600	4300	NUP2218EM	104		117	149		2		3.59	
	160	52.4	2	2	107.2	281	390	3600	4300	NU3218A	99	104	110	151		2	2	4.50	
	190	43	3	3	165	319	342	2800	3400	N318M	103	162		177	168	2.5	2.5	6.05	
	190	43	3	3	169.5	347	385	2800	3400	N318EM	103	166		177	173	2.5	2.5	5.99	
	190	43	3	3	115	396	505	2800	3400	NJ2318M	103	110	127	177		2.5	2.5	9.29	
	190	64	3	3	113.5	475	565	2800	3400	NJ2318E	103	110	127	177		2.5	2.5	8.84	
	225	54	4	4	191.5	429	480	2800	3400	N418M	106	188		209	195	3	3	11.3	
	95	145	24	1.5	1.1	108	117	166	4500	5300	NJ1019M	101.5	104	116	137		1.5	1	1.53
170		32	2.1	2.1	151.5	189	231	3400	4000	N219M	106	149		159	157	2	2	3.07	
170		32	2.1	2.1	154.5	242	291	3400	4000	N219EM	106	152		159	157	2	2	3.19	
170		43	2.1	2.1	151.5	309	315	3400	4000	N2219M	106	152		159	157	2	2	4.27	
200		45	3	3	173.5	330	370	2600	3200	N319M	108	170		187	178	2.5	2.5	6.67	
200		45	3	3	177.5	371	420	2600	3200	N319EM	108	174		187	181	2.5	2.5	7.00	
200		67	3	3	121.5	485	565	2600	3200	NJ2319M	108	116	135	187		2.5	2.5	10.2	
240		55	4	4	201.5	455	525	2600	3200	N419M	111	198		224	205	3	3	13.3	
100	140	20	1.1	1.1	110	75.5	108	3600	4300	NU1920M	102	107	118	133		1	1	0.900	
	150	24	1.5	1.1	113	94.5	129	3600	4300	NJ1020M	105	110	123	132		1	1	1.51	
	180	34	2.1	2.1	160	250	290	3200	3800	N220M	111	157		169	163	2	2	3.45	
	180	34	2.1	2.1	163	271	330	3200	3800	N220E	111	160		169	166	2	2	3.77	

# Single Row Cylindrical Roller Bearings

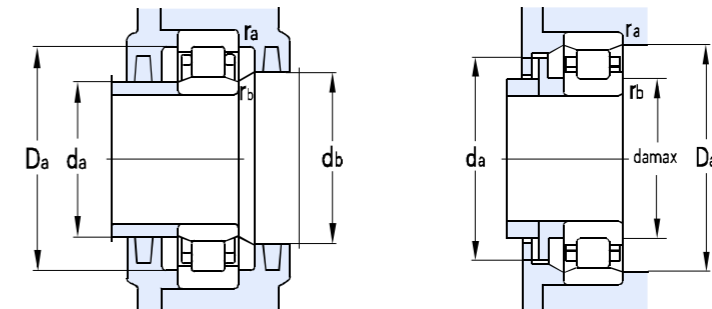
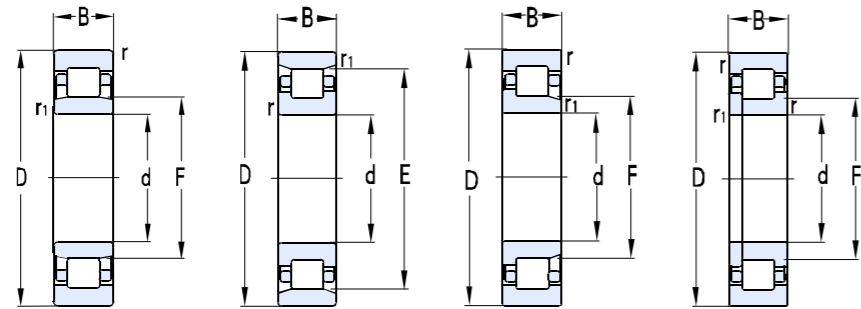

Basic dimensions							Basic load ratings		Limit speed		Designations	Abutment and fillet dimensions						Weight	
d	D	B	rsmin	r1smin	F	E	Cr	Cor	Grease	Oil		da min	da max	db min	Da max	Da max	ra max		rb max
mm							KN		r/min			mm						Kg	
	180	46	2.1	2.1		160	349	385	3200	3800	N2220M	111	116		169	166	2	2	5.25
	180	46	2.1	2.1	119		361	470	3200	3800	NU2220E	111	116	122	169	166	2	2	5.08
	180	60.3	2.1	2.1	120		208	256	3200	3800	NU3220M	121	140	147	244		3	3	6.81
	215	41	3	3	125.1		391	440	2400	3000	NJ320EM	113	124	142	202		2.5	2.5	9.82
	215	47	3	3	129.5		428	418	2400	3000	NUP320M	113		142	202		2.5	2.5	9.05
	215	47	3	3		191.5	428	465	2400	3000	N320EM	113	188		202	195	2.5	2.5	9.67
	215	73	3	3		185.5	637	700	2400	3000	N2320M	113	182		202	190	2.5	2.5	13.1
	215	73	3	3		191.5	637	760	2400	3000	N2320E	113	188		202	195	2.5	2.5	12.9
	250	58	4	4		211	505	590	2400	3000	N420M	116	208		234	215	3	3	15.4
105	160	26	2	1.1		145.5	119	168	4000	4800	N1021M	111.5	166		151	149	2	1	1.85
	190	36	2.1	2.1		168.8	285	299	3000	3600	N221M	116	121		179	172	2	2	4.33
	190	36	2.1	2.1	125		285	315	3000	3600	NJ221EM	116	198	137	179		2	2	4.52
	190	65.1	2.1	2.1	126.8		352	500	3000	3600	NU3221M	116	122	128	179		2	2	8.22
	225	87.3	3	3		196	660	910	2200	2800	N3321M	116	139		208	204	2.5	2.5	18.3
	225	49	3	3		201	475	525	2200	2800	N321EM	118	130		212	203	2.5	2.5	10.5
	260	60	4	4		220.5	576	655	2200	2800	N421M	121	151		244	224	3	3	17.2
110	170	28	2	1.1		155	143	194	3800	4500	N1022M	116.5	123		161	157	2	1	2.31
	170	28	2	1.1	125		143	194	3800	4500	NU1022M	116.5	175	128	161		2	1	2.32
	200	38	2.1	2.1		178.5	270	347	2800	3400	N222M	121	129		189	181	2	2	5.02
	200	38	2.1	2.1		180.5	318	370	2800	3400	N222EM	121	129		189	183	2	2	5.27
	200	53	2.1	2.1	132		418	490	2800	3400	NJ2222M	121	138	145	189		2	2	7.83
	200	69.8	2.1	2.1	132.5		451	655	2800	3400	NU3222M	121	129	135	189		2	2	9.92
	240	50	3	3		207	462	515	2000	2600	N322M	123	139		227	210	2.5	2.5	11.4
	240	50	3	3		211	503	575	2000	2600	N322E	123	204		227	215	2.5	2.5	11.2
	240	80	3	3		211	741	930	2000	2600	N2322E	123	138		227	215	2.5	2.5	17.5
	280	65	4	4		235	615	725	2000	2600	N422M	126	150		264	240	3	3	21.8
120	180	28	2	1.1	135		146	205	3400	4000	NU1024M	126.5	133	138	171		2	1	2.96
	215	40	2.1	2.1		191.5	350	390	2400	3000	N224M	131	140		204	195			6.11
	215	40	2.1	2.1	143.5		374	460	2400	3000	NJ224EM	131		156	204		2	2	6.68
	215	58	2.1	2.1		191.5	480	550	2400	3000	N2224M	131	188		204	195	2	2	8.92
	215	58	2.1	2.1	143.5		494	620	2400	3000	NJ2224EM	131	140	156	204		2	2	9.80
	215	76	2.1	2.1	145.14		517	780	2400	3000	NU3224M	131	140	146	204		2	2	12.4
	240	80	3.7	3.7	150		583	790	2400	3200	NJ624M	140	147	165	222		2.5	2.5	17.7
	260	55	3	3		226	580	645	1900	2400	N324M	133			247	230	2.5	2.5	15.1

# Single Row Cylindrical Roller Bearings

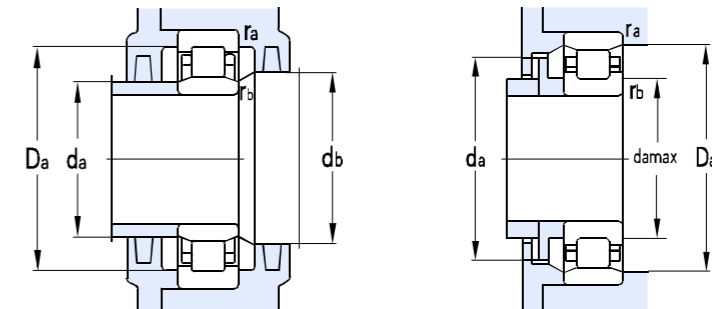
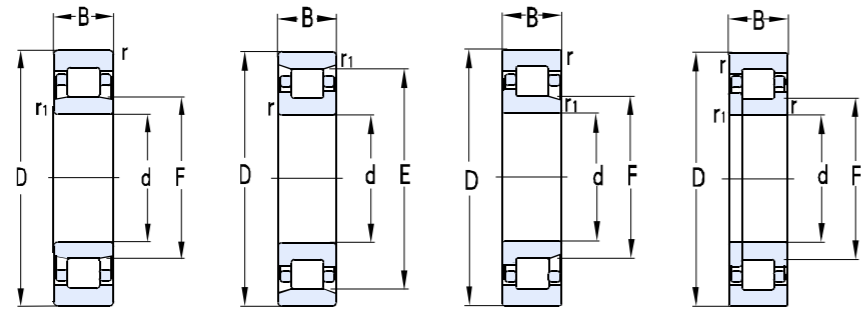

Basic dimensions							Basic load ratings		Limit speed		Designations	Abutment and fillet dimensions						Weight	
d	D	B	rsmin	r1smin	F	E	Cr	Cor	Grease	Oil		da min	da max	db min	Da max	Da max	ra max		rb max
mm							KN		r/min			mm						Kg	
	260	55	3	3	154		594	710	1900	2400	NU324EM	133	150	157	247		2.5	2.5	16.3
	260	86	3	3		226	869	970	1900	2400	N2324M	133	223		247	229	2.5	2.5	22.9
	260	106	3	3		230	990	1380	1900	2400	NF3324Q1	133	149	170	247		2.5	2.5	29.9
	310	72	5	5		260	770	915	1900	2400	N424M	140	254		290	266	4	4	29.0
130	180	50	1.5	1.5	150		220	555	1900	2400	NA4926	150	170	145	160		1.5	1.5	4.36
	200	33	2	1.1		182	192	274	3200	3800	N1026M	136.5	178		191	184	2	1	4.57
	200	42	2	1.1	147		280	415	3000	3700	NU2026EMA	143	149	167	217		1	1	4.95
	230	40	3	3		204	376	465	2200	2800	N226M	143	200		217	207	2.5	2.5	7.08
	230	40	3	3		209.5	394	495	2200	2800	N226E	143	206		217	213	2.5	2.5	7.09
	230	64	3	3		204	580	690	2200	2800	N2226M	143	200		217	209	2.5	2.5	11.6
	230	64	3	3	153.5		580	735	2200	2800	NU2226EM	143	150	159	217		2.5	2.5	11.5
	280	58	4	4		243	600	690	1800	2200	N326M	146	239		264	247	3	3	17.8
	280	58	4	4	167		690	795	1800	2200	NU326EM	146	163	170	264		3	3	15.8
	280	93	4	4		243	870	1180	1800	2200	N2326M	146	240		264	246	3	3	29.0
	280	93	4	4	167		900	1200	1800	2200	NU2326EM	146	161	185	264		3	3	29.3
	340	78	5	5	185		941	1110	1800	2200	NU426M	150	180	190	320		4	4	39.5
140	190	30	1.5	1.1	158		184	315	3000	3600	NF2928M	146.5	155	161	181		2	1	2.59
	210	33	2	2	158		195	290	3000	3600	NJ1028M	146.5	155	161	200		2	2	4.01
	210	53	2	1.1	158		358	630	2600	3400	NU3028M	147	154	162	200		2	1	7.64
	250	42	3	3		221	390	490	2400	3000	N228M	153	218		237	225	2.5	2.5	9.14
	250	42	3	3		225	428	530	2400	3000	N228E	153	221		237	232	2.5	2.5	9.01
	250	68	3	3	169		603	755	2000	2600	NU2228M	153	164	172	237		2.5	2.5	14.4
	250	68	3	3		225	622	840	2000	2600	N2228E	154	218	224	236		2.5	2.5	14.2
	300	62	4	4		260	710	810	1900	2400	N328M	156	256		284	264	3	3	21.9
	300	62	4	4	180		740	880	1800	2200	NU328EM	156	176	183	284		3	3	21.8
	360	82	5	5	196		1010	1200	1800	2200	NJ428M	160	192	219	340		4	4	46.3
	300	102	4	4		260	1140	1310	1800	2200	N2328M	156	256		284	264	3	3	34.6
150	225	35	2.1	1.5	169.5		212	310	2600	3200	NJ1030M	159	166	178	214		2	2	5.05
	270	45	3	3		238	430	570	2000	2600	N230M	163	234		257	242	2.5	2.5	11.6
	270	45	3	3		242	484	610	1900	2400	N230E	163	238		257	246	2.5	2.5	11.5
	225	56	2.1	2.1	169.5		363	620	2400	3000	NU3030M	159	166	172	214		2	2	7.99
	270	73	3	3	182		698	980	1900	2400	NJ2230E	163	177	197	257		2.5	2.5	18.1
	320	65	4	4		277	826	890	1700	2000	N330M	166	272		304	282	3	3	26.5
	320	65	4	4	193		855	1010	1700	2000	NJ330EM	166	189	213	304		3	3	26.2

# Single Row Cylindrical Roller Bearings

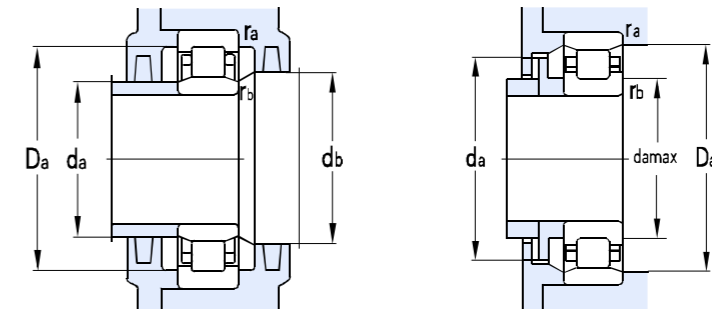
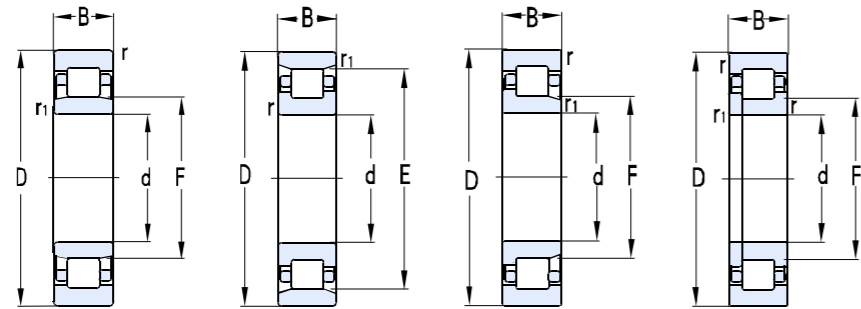

Basic dimensions							Basic load ratings		Limit speed		Designations	Abutment and fillet dimensions						Weight	
d	D	B	rsmin	r1smin	F	E	Cr	Cor	Grease	Oil		da min	da max	db min	Da max	Da max	ra max		rb max
mm							KN		r/min			mm						Kg	
	320	108	4	4	193		1300	1480	1700	2000	NU2330M	166	186	196	304		3	3	41.5
	320	108	4	4		277	1300	1420	1700	2000	N2330M	166			304	284	3	3	42.8
	320	128	4	4	193		1320	1880	1400	1800	NJ3330M	166	189	213	304		3	3	49.9
160	220	36	2	2	173		255	435	2500	3200	NJ2932M	169	171	181	211		1.5	1.5	4.17
	240	38	2.1	2.1		220	260	365	2400	3000	N1032M	168	217		232	223	2	2	5.96
	290	48	3	3		257	556	655	1800	2200	N232M	173	255		277	263	2.5	2.5	14.3
	290	48	3	3	195		556	695	1800	2200	NU232EM	173	191	198	277		2.5	2.5	14.3
	290	80	3	3	193		883	1190	1800	2200	NU2232EM	173	189	196	277		2.5	2.5	24.2
	290	80	3	3	195		810	1000	1800	2200	NJ2232M	173	189	196	277		2.5	2.5	23.9
	340	68	4	4		292	950	1026	1500	1800	N332M	176	288		324	296	3	3	30.8
	340	68	4	4	204		950	1150	1500	1800	NU332EQ1	176	200	207	324		3	3	27.8
	340	114	4	4		292	1187	1610	1350	1700	N2332M	176	200	209	324		3	3	51.6
	340	114	4	4	204		1260	1730	1350	1700	NU2332EM	176	200	209	324		3	3	52.4
	170	230	28	2	1.1		216	193	310	2400	2900	N1934M	180		213	222	219	1.5	1
260		42	2.1	2.1		237	299	400	2200	2800	N1034M	181	233		249	241	2	2	8.02
310		52	4	4		272	660	780	1800	2200	N234M	186	266		294	278	3	3	18.2
310		52	4	4	207		660	870	1800	2200	NU234EM	186	203	210	294		3	3	18.4
310		86	4	4	205		1000	1480	1800	2200	NU2234EM	186	201	208	294		3	3	29.0
310		86	4	4	208		1000	1480	1800	2200	NU2234M	187	203	211	293		3	3	30.5
340		114	4	4		292	1120	1610	1500	1800	N2332M	176	288		324	295	3	3	51.6
360		72	4	4		310	904	1040	1400	1700	N334M	186	307		344	315	3	3	37.3
360		120	4	4	220		1380	1850	1400	1700	NJ2334M	186	212	240	344		3	3	62.5
180		250	33	2	1.1		233	237	380	2200	2800	NF1936M	190			240	236	1.5	1.5
	280	31	2	2		250	270	420	2000	2400	N036M	191	246		269	254	2	2	8.59
	280	31	2	2		250	270	420	2000	2400	N036L	191	246		269	254	2	2	7.08
	280	31	2	2		260	330	472	2000	2400	N036EM	191	246		269	254	2	2	7.15
	280	46	2.1	2.1		255	380	565	2000	2600	N1036M	191	221		265	260	2	2	10.3
	320	52	4	4		282	685	785	1700	2000	N236M	196	278		304	286	3	3	19.7
	320	86	4	4	215		1100	1580	1700	2000	NU2236M	196	211	218	304		3	3	31.4
	320	112	4	4	218		1120	1950	1700	2000	NU3236M	196	211	218	304		3	3	41.6
	380	75	4	4		330	990	1260	1500	1800	N336M	196	325		364	335	3	3	39.6
	380	75	4	4	231		1170	1360	1500	1800	NU336EM	196	226	236	364		3	3	42.1
	380	126	4	4	232		1530	1850	1300	1600	NJ2336M	196	227	255	364		3	3	72.0

# Single Row Cylindrical Roller Bearings

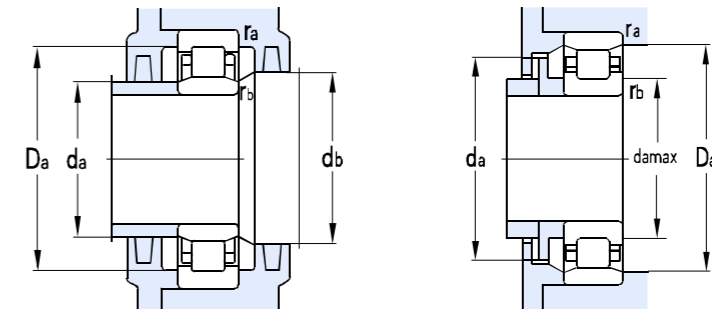
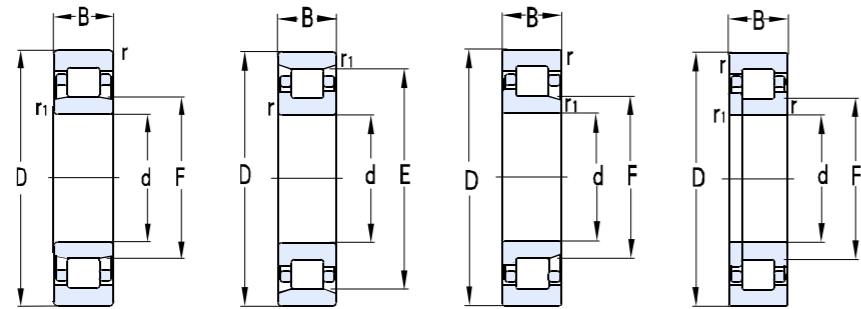

Basic dimensions							Basic load ratings		Limit speed		Designations	Abutment and fillet dimensions						Weight	
d	D	B	rsmin	r1smin	F	E	Cr	Cor	Grease	Oil		da min	da max	db min	Da max	Da max	ra max		rb max
mm							KN		r/min			mm						Kg	
190	260	42	2	2	208		315	610	2200	2800	NJ2938	196	206	210	252		1.5	1	7.24
	290	46	2.1	2.1	215		413	640	2000	2600	NU1038M	201	212	218	279		2	2	10.9
	340	55	4	4	231		730	916	1600	1900	NU238M	206	226	234	324		3	3	21.6
	400	78	5	5		345	1080	1730	1200	1500	N338M	210	340	380	350		4	4	50.2
	400	132	5	5	240		1870	2450	1200	1500	NU2338EMA	210	235	249	380		4	4	82.8
200	310	34	2	2		277	336	545	2200	2800	N040M	211	274		299	280	2	2	10.1
	310	51	2.1	2.1	227		468	705	1900	2400	NU1040M	211	225	233	299		2	2	14.3
	320	48	2.1	2.1		283	473	705	1900	2400	N640M	211	280		299	286	2	2	14.7
	360	58	4	4		316	808	995	1500	1800	N240M	216	310		344	322	3	3	26.8
	360	98	4	4	244		1200	1710	1500	1800	NJ2240M	216	236	260	344		3	3	45.5
	360	98	4	4		325	1300	1900	1500	1800	N2240EM	216	320		344	330	3	3	44.9
	420	80	5	5	260		1090	1400	1300	1600	NU340M	220	253	264	400		4	4	56.7
	420	138	5	5		364	1880	2510	1200	1500	N2340M	220	360		400	368	4	4	94.5
	420	165	5	5	260		2150	3540	1200	1500	NU3340M	220	253	264	400		4	4	118
220	300	48	2.1	2.1	240		407	755	1900	2400	NJ2944M	229	237	243	289		2	1	10.8
	340	56	3	3	250		534	810	1800	2200	NJ1044M	233	246	265	327		2.5	2.5	19.6
	340	90	3	3	251.409		1060	1820	1800	2200	NU3044Q1/HA	233	246	254	327		2.5	2.5	32
	400	65	4	4		350	1000	1220	1500	1800	N244M	236	342		384	358	3	3	36.7
	400	108	4	4	270		1500	1990	1300	1600	NU2244M	236	262	274	384		3	3	62.2
	400	144	4	4	270		1950	3350	1500	1800	NB3244F1	236	263	276	384		3	3	77.3
	400	108	4	4	265		1490	2280	1300	1600	NU2244EM/HC	237	255	264	383		3	3	62.8
	400	108	4	4		350	1440	1990	1300	1600	N2244M	237	255	360	383		3	3	61.8
	460	88	5	5	284		1280	1730	1000	1300	NU344M	240	277	288	440		4	4	73.4
	460	145	5	5	284		2260	3270	1000	1300	NU2344M	240	276	288	440		4	4	125
	460	145	5	5		407	2300	3360	1000	1300	N2344EM	240	403		440	411	4	4	114
	240	320	38	2.5	1.8	260		308	540	1900	2400	NU1948M	249	257	263	308		2	1.5
360		56	3	3	270		512	775	1700	2000	NU1048M	253	266	274	347		2.5	2.5	20.5
440		72	4	4	295		1050	1540	1300	1600	NU248M	256	288	299	424		3	3	46.9
440		72	4	4		385	1050	1540	1300	1600	N248M	256	288	317	424		3	3	49.1
440		120	4	4	295		1490	2450	1200	1500	NU2248MA	256	284	299	423		3	3	84.8
440		146	4	4	290		2240	3820	1100	1400	NU5248	256	287	293	424		3	3	104
500		95	5	5		430	1530	2120	1000	1300	N348M	260	426		480	434	4	4	96.3
500		95	5	5	306		1670	2190	1000	1300	NU348EM	260	296	313	480		4	4	94.9
500		155	5	5	310		2470	3460	950	1200	NU2348M	260	296	314	480		4	4	154

# Single Row Cylindrical Roller Bearings

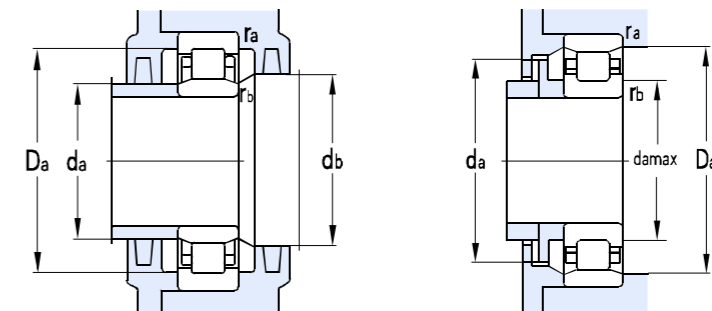
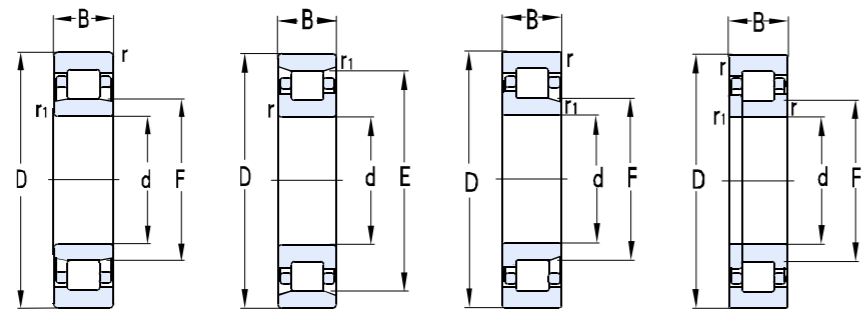

Basic dimensions							Basic load ratings		Limit speed		Designations	Abutment and fillet dimensions						Weight	
d	D	B	rsmin	r1smin	F	E	Cr	Cor	Grease	Oil		da min	da max	db min	Da max	Da max	ra max		rb max
mm							KN		r/min			mm						Kg	
250	308	50	6	2.3			655	1050	1800	2300	N650EM/HA	268	343		368	351	5	2	21.4
260	360	46	2.1	2.1		337	445	785	1600	1850	NF1952M	276	280	295	384		3	3	14.9
	400	65	4	4		347	690	1090	1500	1800	NU1052M	276	291	300	384		3	3	30.2
	400	82	4	4	294		1080	1880	1300	1700	NU2052EM	276	291	300	384		3	3	40.1
	400	104	4	4	290.5		1350	2340	1150	1450	NU3052M	275	286	295	385		3	3	49.5
	440	144	4	4	298.5		2050	3450	950	1250	NU3152M	277	295	302	423		3	3	98
	480	80	5	5	320		1220	1800	1100	1400	NU252M	280	313	324	460		4	4	67.1
	480	130	5	5		420	1780	2910	950	1250	N2252M	280	416	427	460		4	4	105
	540	102	6	6	336		1843	2560	850	1050	NU352M	286	330	341	514		5	5	120
	540	165	6	6	319		3150	4500	850	1050	NU2352M	286	310	323	514		5	5	188
280	340	30	2	2		327	308	690	1800	2200	N1856X3M/HG2	289		324	330	330	2	2	5.76
	350	42	2	2	299		363	790	1800	2200	NJ2856M	289	309	324	330		2	2	9.15
	360	30	2	2	301		385	625	1700	1900	NJ1856X3M/HG2	289	309	334	340		2	2	8.11
	380	46	2.1	2.1	306		473	865	1700	1900	NU1956M	291	303	309	369		2	2	15.5
	420	65	4	4		384	700	1150	1400	1700	N1056M	296	380		411	388	3	3	31.5
	420	82	4	4	314		1190	2170	1050	1300	NU2056M	295	310	318	405		3	3	39.5
	460	146	5	5	321		2250	3900	900	1150	NU3156M	300	316	325	440		4	4	106
	500	80	5	5	340		1100	1750	1150	1450	NJ256M	300	333	364	480		4	4	71.5
	500	130	5	5	333		2080	3270	1100	1400	NU2256EM	300	333	344	480		4	4	118
	580	108	6	6	362		1880	2660	850	1000	NU356M	306	347	366	554		5	5	147
	580	175	6	6	362		2560	4250	900	1100	NU2356M	306	347	366	554		5	5	232
300	380	48	2.1	2.1	321		450	1000	1370	1650	NJ2860M	310	318	332	370		1.5	1.5	15.5
	380	60	2.1	2.1		360	468	990	1200	1500	N3860M/HG2	316	335		444	440	4	4	16.6
	460	74	4	4	340		935	1510	1200	1500	NJ1060M	316	335	358	444		3	3	45.1
	460	95	4	4	341		1400	2510	980	1250	NU2060M	317	336	345	443		3	3	60
	460	118	4	4	340		1470	2700	1200	1500	NU3060M	316	335	344	444		3	3	72.5
	540	85	5	5	364		1510	2270	1000	1300	NU260M	320	358	368	520		4	4	86.9
	540	140	5	5	364		2080	3450	1000	1200	NU2260M	320	352	368	520		4	4	146
	620	109	7.5	7.5	385		2310	3300	900	1100	NU360M	330	379	390	590		7	7	166
620	185	7.5	7.5	371		3860	5850	830	1000	NU2360M	332	365	375	588		6	6	271	
320	400	38	2.1	1.5	341		365	715	1270	1550	NU1864M	327	337	345	389		2	1.5	11.3
	400	48	2.1	1.5	341		490	1050	1250	1550	NU2864M	327	337	345	389		2	1.5	15
	440	56	3	3	350		638	1130	1100	1400	NU1964M	335	346	354	425		2.5	2.5	24.7

# Single Row Cylindrical Roller Bearings

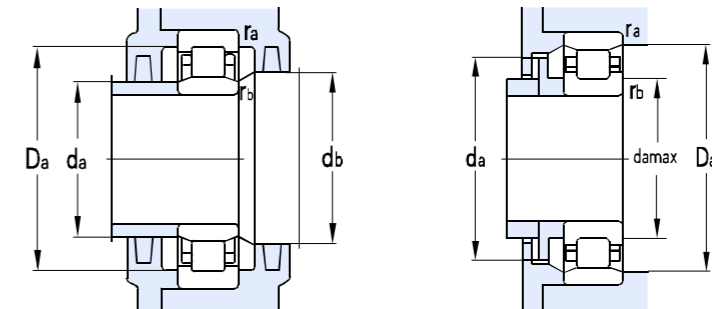
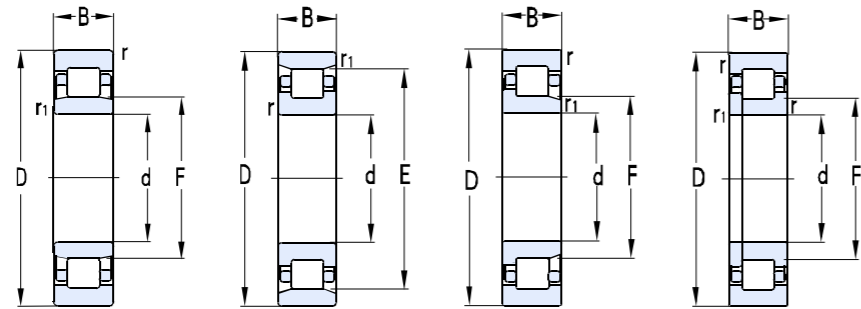

Basic dimensions							Basic load ratings		Limit speed		Designations	Abutment and fillet dimensions						Weight	
d	D	B	rsmin	r1smin	F	E	Cr	Cor	Grease	Oil		da min	da max	db min	Da max	Da max	ra max		rb max
mm							KN		r/min			mm						Kg	
	480	74	4	4	360		960	1580	1100	1400	NJ1064M	336	355	380	464		3	3	47.8
	480	95	4	4	360		1380	2650	970	1250	NU2064M	335	357	364	465		3	3	63
	480	121	4	4	360		1540	2910	1100	1400	NU3064M	336	335	380	464		3	3	78.1
	540	176	5	5	374		2780	5000	870	1050	NU3164M	367	369	387	490		4	4	172
	580	92	5	5	390		1620	2450	960	1200	NU264M	340	383	394	560		4	4	112
	580	150	5	5	380		3030	4750	900	1100	NU2264EM	340	377	394	560		4	4	181
340	420	48	2.1	2.1	361		490	1150	1150	1450	NJ2868M	350	357	372	410		2		15.5
	460	56	3	3	370		700	1400	1050	1350	NU1968M	353	365	374	447		2.5	2.5	28.3
	460	72	3	3	373		785	1650	1050	1350	NU2968M	353	369	377	447		2.5	2.5	36.2
	520	82	5	5	385		1130	1910	1000	1300	NU1068M	360	380	389	500		4	4	65.0
	580	190	5	5	399		3300	5900	760	910	NU3168E	360	388	403	560		4	4	211
	580	190	5	5	400		3550	6650	760	910	NU3168	360	388	403	560		4	4	211
	620	165	6	6	416		2950	4900	810	950	NU2268M	366	401	421	594		5	5	225
	620	224	6	6	410		4600	8600	810	950	NU3268	366	401	421	594		5	5	307
360	480	72	3	3	388		1220	2300	1100	1300	NJ2972E	380	400	380	464		4	4	38.1
	540	82	5	5	405		1190	2000	980	1280	NU1072M	378	400	410	522		4	4	65.9
	540	106	5	5	405		1890	3560	870	1050	NU2072M	380	399	410	520		4	4	89.5
	540	134	5	5	405		2060	4050	800	1000	NU3072M	381	400	410	520		4	4	112
	600	192	5	5	420		3520	6500	900	1000	NU3172	373	417		587	423	4	4	219
	650	170	6	6	437		3150	5400	800	950	NU2272M	386	428	442	624		5	5	262
	750	224	7.5	7.5	455		4900	7600	700	850	NUP2372M	390	445	460	720		7	7	513
380	480	60	2.1	2.1	406		550	680	900	1180	N2876	390	401	410	470		2	2	25.9
	480	46	2.1	2.1	406		525	1050	950	1250	NU1876M	390	401	410	470		2	2	23.5
	520	82	4	4			1180	2540	920	1200	N2976M	400	419	428	490		3	3	82.8
	560	82	5	5	425		1220	2090	950	1200	NU1076M	400	420	430	540		4	4	71.0
	560	106	5	5	425		1930	3750	800	950	NU2076EM	398	422	430	542		4	4	93
	560	135	5	5	425		2250	4700	800	950	NU3076EM	398	417	430	542		4	4	116
	680	175	6	6	462		3760	6080	730	860	NU2276EM	406	445	457	654		5	5	276
400	500	46	2.1	2.1	423		565	1150	980	1250	NU1880M	410	419	428	490		2	2	21.2
	500	75	2.1	2.1	425		855	2010	980	1250	NU3880Q1	410	419	428	490		2	2	33.4
	540	65	4	4	435		900	1750	900	1150	NU1980M	415	429	439	525		3	3	42
	540	82	4	4	435		1350	2850	900	1150	NU2980EM	415	429	439	525		3	3	57.8
	540	82	4	4	438		1250	2510	900	1150	NU2980M	415	434	442	525		3	3	55.2

# Single Row Cylindrical Roller Bearings

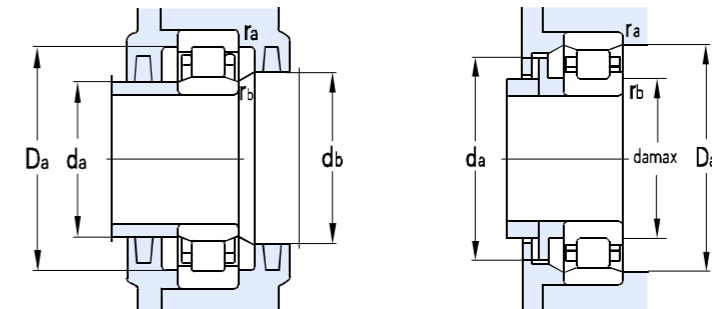
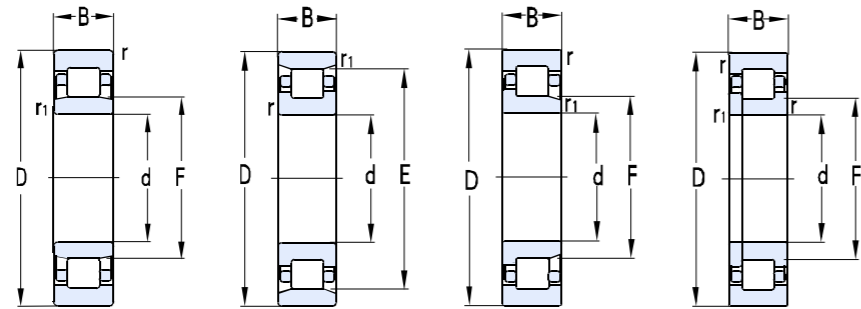

Basic dimensions							Basic load ratings		Limit speed		Designations	Abutment and fillet dimensions						Weight		
d	D	B	rsmin	r1smin	F	E	Cr	Cor	Grease	Oil		da min	da max	db min	Da max	Da max	ra max		rb max	
mm							KN		r/min			mm						Kg		
	600	90	5	5	450		1450	2470	900	1100	NU1080M	420	446	455	580		4	4	92.5	
	600	118	5	5	449		2150	4800	750	900	NU2080EM	418	446	454	582		4	4	122	
	600	148	5	5	450		2330	4550	900	1100	NU3080M	420	446	455	580		4	4	153	
	650	145	6	6	460		2920	5190	700	850	NU2180M	420	450	460	590		4	4	197	
	650	200	6	6	460		3760	7170	700	850	NU3180M	420	450	460	590		4	4	274	
420	520	46	2.1	2.1	447		605	1270	900	1100	NU1884	440	466	380	500		2	2	20.7	
	520	75	2.1	2.1	447		900	2250	930	1150	NJ3884M	427	441	462	510		2	2	33.3	
	560	65	4	4		528	1080	2010	930	1150	NF1984F3	435	523		530	533			45.2	
	560	65	4	4	449		1080	1950	930	1150	NJ1984MA	435	442	466	545		3		46	
	560	82	4	4	458		1290	2800	930	1150	NU2984M	435	452	463	545		3	3	58.1	
	620	90	5	5	470		1440	2490	900	1100	NU1084M	440	466	475	600		4	4	98.0	
	620	118	5	5	469		2400	4750	770	950	NU2084EM	438	466	474	602		4	4	127	
	620	150	3	5		574	2850	5450	770	950	NF3084EM	438	466		602	586		4	4	162
	700	224	6	6	485		4950	8950	650	780	NU3184EM	446	478	490	694		5	5	368	
440	540	60	2.1	2.1	464		790	1900	870	1050	NU2888EM	450	459	469	530		2	2	34.5	
	600	74	4	4	482		1010	1980	870	1050	NU1988M	455	477	487	585		3	3	65	
	600	95	4	4	481.5		1670	3550	870	1050	NJ2988EM	455	477	500	585		3		83.5	
	600	118	4	4	481.5		1940	4250	850	1000	NUP3988EM	455		483	585		3		106	
	650	94	6	6	493		1570	2430	850	1000	NU1088M	466	488	498	624		5	5	102	
	650	122	6	6	487		2450	5000	670	820	NU2088EM	463	483	492	627		5	5	146	
	720	122	6	6		648	2850	4300	800	950	N1188	466	488		690	670		5	5	207
	720	226	6	6	508		5230	9800	600	750	NU3188	460	498	518	700		5	5	374	
445	815	210	7.5	7.5	539		4800	7950	750	1100	NU689M	478	535	560	770		6	6	501	
460	580	56	3	3		553	795	1720	800	950	N1892M	473	548		567	558	2.5	2.5	37.2	
	580	72	3	3	489		1030	2350	800	950	NJ2892EM	473	485	505	567		2.5		48.7	
	620	95	4	4	502		1640	3500	800	950	NJ2992	486	511	550	610		3	3	83.4	
	680	100	6	6	516		1690	2630	800	950	NU1092M	486	511	521	654		5	5	111	
	680	128	6	6	513		2700	5450	650	800	NU2092EM	483	509	518	657		5	5	166	
	680	163	6	6	516		2970	6150	650	790	NU3092M	483	496	508	657		5	5	211	
	680	163	6	6	499		3300	6340	650	790	NU3092EM	483	491	504	657		5	5	211	
	760	240	7.5	7.5	531		5450	10400	400	480	NU3192	490	526	536	730		6	6	467	
	830	165	7.5	7.5	554		4200	6800	600	720	NU1292	492	542	559	798		6	6	405	
	830	212	7.5	7.5	554		4860	8200	580	670	NU2292M	492	542	559	798		6	6	515	



# Single Row Cylindrical Roller Bearings

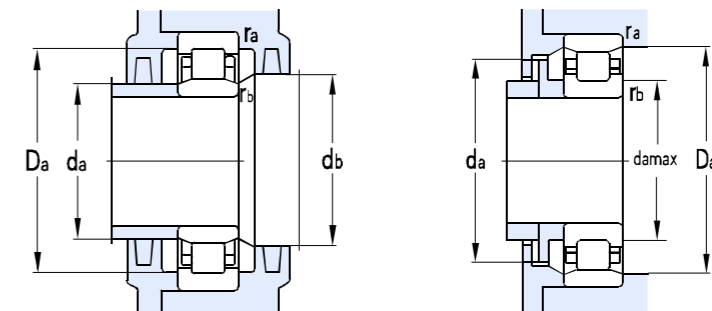
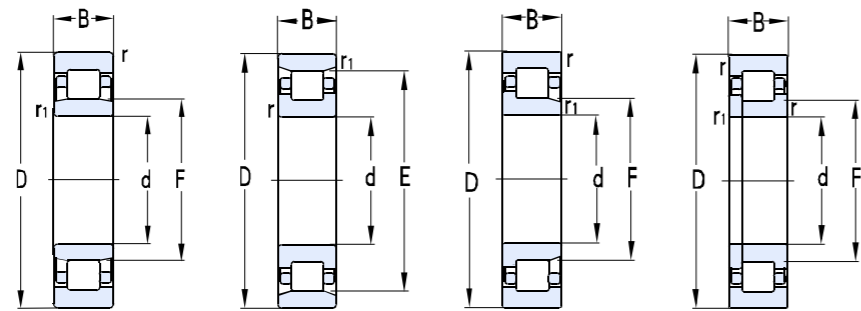

Basic dimensions							Basic load ratings		Limit speed		Designations	Abutment and fillet dimensions						Weight		
d	D	B	rsmin	r1smin	F	E	Cr	Cor	Grease	Oil		da min	da max	db min	Da max	Da max	ra max		rb max	
mm							KN		r/min			mm						Kg		
480	600	56	3	3	511		750	1620	840	950	NU1896M	439	507	516	587		2.5	2.5	37.5	
	600	72	3	3	509.5		1050	2400	840	950	NJ2896EM	493	504	524	587		2.5	2.5	46.5	
	700	100	6	6	536		1600	2970	720	860	NU1096M	503	531	538	677		5	5	128	
	700	128	6	6	536		2600	5250	600	720	NU2096MA	503	529	538	677		5	5	176	
	790	248	7.5	7.5	547		5650	10700	500	600	NU3196EM	512	536	552	758		6	6	495	
	790	248	7.5	7.5	556		5700	11000	500	600	NU3196M	512	545	561	767		6	6	508	
500	620	56	3	3		592	795	1700	780	940	NF18/500EM	513			607	598		2.5	2.5	38.5
	620	72	3	3	530		1130	2670	780	940	NU28/500EM	513	526	534	607		2.5	2.5	48.5	
	670	78	5	5	544		1160	2350	720	880	NU19/500EM	518	537	549	652		4	4	80	
	670	100	5	5	543		1930	4300	750	900	NU29/500	522	537	549	648		3	3	101	
	670	128	5	5		633	2250	5150	670	840	N39/500EM	518	627	638	652		4		128	
	720	100	6	6	556		1680	3050	720	880	NJ10/500	523	550		697		5	5	136	
	720	128	6	6	553		2850	5900	620	720	NU20/500EM	523	549	558	697		5	5	175	
	720	167	6	6	556		3210	6970	620	720	NU30/500	523	530	545	697		5	5	232	
	830	264	7.5	7.5	581		6250	12200	480	580	NU31/500	532	550	580	798		6	6	602	
	920	185	7.5	7.5	603.1		5050	8450	540	650	NU12/500M	532	593	610	888		6	6	585	
530	650	72	3	3		622	1170	2890	900	1100	NF28/530	544			645	625		2.5	2.5	52.2
	710	82	5	5	573		1500	2980	680	830	NJ19/530EM	548	568	598	692		4		94.5	
	710	106	5	5	580		2000	4800	400	500	NU29/530F3	555	585	605	585		4	4	125	
	780	112	6	6	593		2200	4050	650	780	NU10/530M	553	585	598	757		5	5	187	
	780	145	6	6	591		3650	7360	550	650	NU20/530EM	553	587	596	757		5	5	252	
	870	272	7.5	7.5	612		7500	13500	460	550	NU31/530EM	562	605	617	838		6	6	663	
560	680	56	3	3	591		810	1830	670	820	NJ18/560M	573	584	606	667		2.5	2.5	42.5	
	680	72	3	3		651	1170	2950	670	820	NF28/560	573	645		665	657		2.5	2.5	53
	750	85	5	5	608		1660	3250	650	780	NJ19/560	578	600	613	732		4	4	111	
	750	112	5	5	607		2400	5450	650	780	NJ29/560	586	620	693	724		4	4	148	
	750	112	5	5		703	2420	5600	650	780	N29/560	586		693	724	713		4	4	138
	820	115	6	6	625		2250	4200	620	720	NU10/560M	583	617	630	797		5	5	215	
	820	150	6	6	626		3650	7600	500	600	NU20/560EM	583	616	631	797		5	5	289	
	1030	206	9.5	9.5	668		6850	11000	460	550	NU12/560MA	600	657	674	990		8	8	809	
600	730	60	3	3	632		860	2000	650	780	NU18/600EM	613	625	637	717		2.5	2.5	49.3	
	730	78	3	3	632		1250	3350	620	730	NU28/600EM	613	625	637	717		2.5	2.5	68.5	
	800	90	5	5	649		1860	3600	620	750	NU19/600	618	642	645	782		4	4	128	

# Single Row Cylindrical Roller Bearings

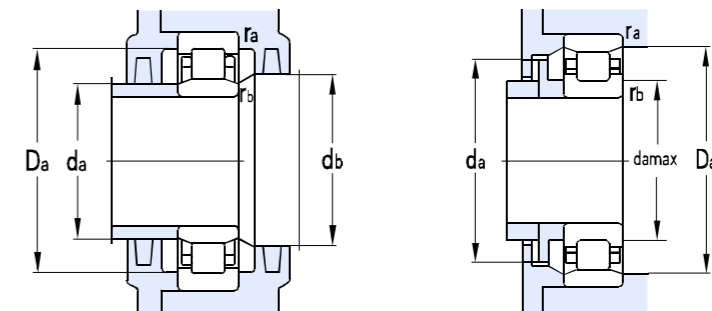
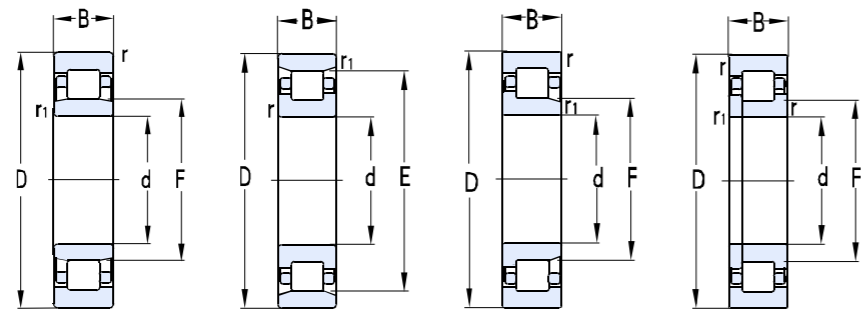

Basic dimensions							Basic load ratings		Limit speed		Designations	Abutment and fillet dimensions						Weight	
d	D	B	rsmin	r1smin	F	E	Cr	Cor	Grease	Oil		da min	da max	db min	Da max	Da max	ra max		rb max
mm							KN		r/min			mm						Kg	
	800	118	5	5	649		2900	6550	620	750	NU29/600E	618		675	782		4	4	163
	830	150	5	5	655		3410	7450	600	700	NU6/600	619	647	703	806		4	4	237
	870	118	6	6	667		2840	5250	590	680	NU10/600	623	658	672	847		5	5	234
	870	155	6	6	661		4180	8000	500	600	NU20/600EM	623	652	667	847		5	5	320
	870	200	6	6	661		5390	11000	500	600	NU30/600E	623	655	666	847		5	5	412
	1090	155	9.5	9.5	740		5330	9200	500	600	NU2/600MA/HC	623	655	666	1062		8	8	686
620	780	102	4	4	740		1950	4800	600	750	NFP6/620Q1	654	680	695	765		3	3	124
	780	102	4	4	740		1950	4800	600	750	N620/780	654	680	695	765		3	3	124
630	780	69	4	4	667		1050	2500	630	750	NJ18/630EM		662	685	765		3	3	74.2
	780	88	4	4		744	1800	4500	630	750	N28/630M	645	737		765	744	3	3	95.6
	780	112	4	4		745	2150	5750	550	650	N38/630M	645	739	750	765		3	3	118
	850	100	6	6	688		1980	4000	600	700	NU19/630M	653	681	694	827		5	5	158
	850	100	6	6	683		2150	4250	600	700	NU19/630EM	653	676	688	827		5	5	160
	850	128	6	6	688		3050	6950	580	680	NU29/630	653	678	689	827		5	5	210
	850	128	6	6	683		3250	7250	580	680	NU29/630EM	653	678	689	827		5	5	214
	920	128	7.5	7.5	702		3400	6250	450	530	NU10/630EM	658	691	706	892		6	6	284
	920	170	7.5	7.5	699		4700	9500	480	560	NU20/630EM	658	690	705	892		6	6	395
	920	212	7.5	7.5	699		6450	14500	450	530	NU30/630	658	690	705	892		6	6	485
670	820	69	4	4	708		1230	2800	550	650	NJ18/670		700	727	805		3		83.8
	820	112	4	4	706		2570	7000	560	670	NJ38/670Q1	640	700	727	805		3	3	133
	900	103	6	6	731		2420	4900	530	630	NU19/670	693	730	755	877		5	5	193
	980	136	7.5	7.5	747		3700	6800	430	500	NU10/670	698	736	753	952		6	6	344
	980	180	7.5	7.5	746		5400	11500	430	500	NU20/670E	698	736	752	952		6	6	477
	980	230	7.5	7.5		914	6930	15000	430	500	N30/670		908		952	919	3		594
	980	230	7.5	7.5	744		6500	14500	430	500	NU30/670M	698	736	750	952		6	6	596
700	930	160	6	6	760		3520	8500	500	600	NUP6/700	733		772	900		5	5	316
710	870	74	4	4		830	1450	3370	500	600	N8/710	725			855	835	3	3	102
	870	95	4	4		831	1880	4950	480	560	N28/710EM	725	825		855	835	3	3	128
	950	106	6	6	770		2590	5500	480	560	NU19/710	740	755		900		5	5	210
	950	140	6	6	766		3650	8250	480	560	NU29/710EM	733	760	772	927		5	5	294
	950	140	6	6	776		3000	7000	480	560	NU29/710M	733	760	772	927		5	5	291
	1030	140	7.5	7.5	778		4550	8400	420	490	NU10/710EM	738	769	783	1002		6	6	420

# Single Row Cylindrical Roller Bearings

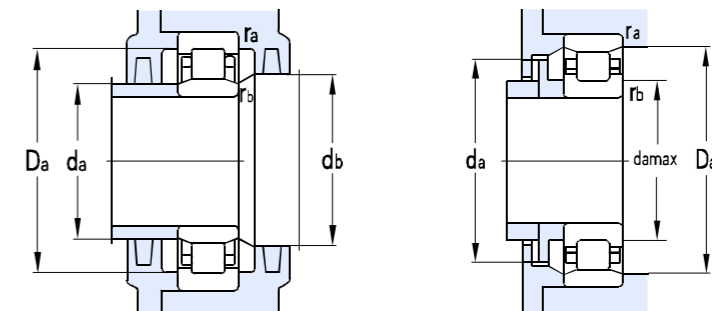
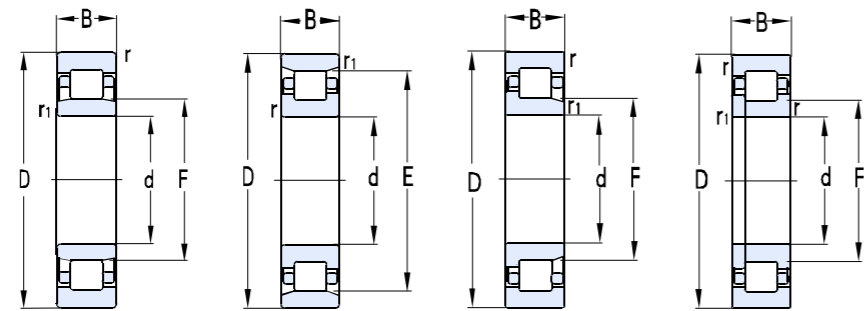

Basic dimensions							Basic load ratings		Limit speed		Designations	Abutment and fillet dimensions						Weight	
d	D	B	rsmin	r1smin	F	E	Cr	Cor	Grease	Oil		da min	da max	db min	Da max	Da max	ra max		rb max
mm							KN		r/min			mm						Kg	
	1030	185	7.5	7.5	787		5800	12000	420	490	NU20/710EM	738	780	793	1002		6	6	535
751	920	78	5	5	794		1510	3480	480	590	N18/750M	770	784	800	900		4	4	102
	920	100	5	5		880	2160	5500	480	590	N28/750	773	875		900	885	5	5	145
	1000	112	6	6		943	2750	5750	470	550	NF19/750EM	773	938		977	953	5	5	264
	1090	150	7.5	7.5	830		4500	8500	350	415	NU10/750EM	778	823	838	1062		6	6	492
	1090	195	7.5	7.5	832		6700	14500	350	415	NU20/750EM	778	823	838	1062		6	6	634
800	980	82	5	5		936	1690	4000	430	510	NF18/800	818	930		950	942	5	5	133
	980	82	5	5	846		1700	4200	430	510	NJ18/800EM	818	838	866	962		4		144
	1150	155	7.5	7.5	883		5400	10500	320	380	NU10/800EM	828	869	889	1122		6	6	565
	1150	200	7.5	7.5	882		6900	14500	320	380	NU20/800EM	828	868	888	1122		6	6	710
820	990	72	5	5		943	1180	2960	450	530	N6/820	840	937		970	944	4	4	128
850	1030	106	5	5	902		2050	5900	410	480	NU28/850M	868	891	908	1012		4	4	192
	1120	118	6	6	919		2930	7000	390	460	NJ19/850	873	909	926	1097		5	5	326
	1120	155	6	6		1059	4500	11300	390	460	N29/850EM	873	1052		1097	1070	5	5	428
900	1090	85	5	5	949		1900	4850	370	440	NU18/900M	918	942	956	1072		4	4	172
	1090	112	5	5	949		2650	7150	370	440	NU28/900M	918	944	956	1072		4	4	234
	1090	140	5	5	945		3300	9100	350	420	NU38/900								268
	1180	122	6	6	966.5		4050	8700	350	420	NU19/900EM	923	957	973	1157		5	5	378
	1180	165	6	6	969		5750	13500	350	420	NU29/900EM	923	958	975	1157		5	5	565
	1200	150	6	6		1124	4450	10200	350	420	N6/900	923	985		1165		5	5	485
950	1250	175	7.5	7.5	1024		5560	13000	340	400	NU29/950	978	1013	1013	1222		6	6	596
1000	1220	100	6	6	1053		2650	6550	350	420	NU18/1000M	1023	1040	1060	1197		5	5	264
	1220	128	6	6	1053		3600	9500	350	420	NJ28/1000EM	1023	1040	1082	1197		5		345
	1320	185	7.5	7.5	1082		6700	17000	290	350	NU29/1000E	1028	1072	1089	1292		6	6	705
1060	1280	128	6	6		1225	3550	10500	310	370	N28/1060M	1083	1218		1257	1230	5	5	355
	1400	195	7.5	7.5	1146		7200	17000	290	350	NU29/1060EM	1028	1133	1152	1372		6	6	875
	1400	250	7.5	7.5	1146		9000	23500	250	310	NU39/1060EM	1028	1140	1153	1372		6	6	1060
	1500	325	9.5	9.5		1390	12500	32500	230	290	N30/1060	1094	1382		1466	1402	8	8	1880

# Single Row Cylindrical Roller Bearings

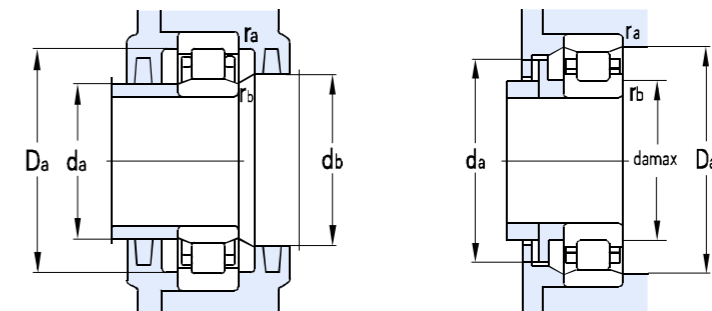
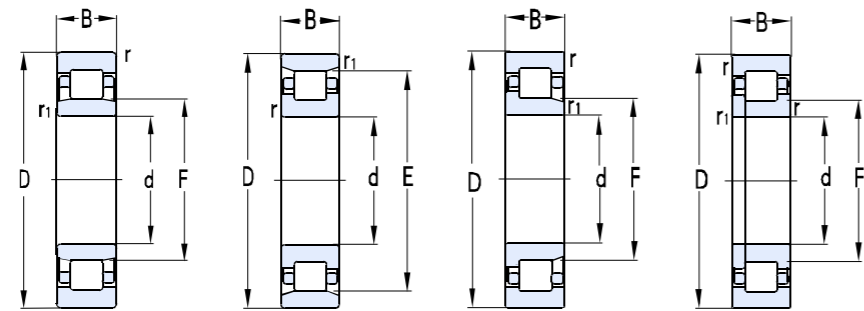

Basic dimensions							Basic load ratings		Limit speed		Designations	Abutment and fillet dimensions						Weight	
d	D	B	rsmin	r1smin	F	E	Cr	Cor	Grease	Oil		da min	da max	db min	Da max	Da max	ra max		rb max
mm							KN		r/min			mm						Kg	
1120	1360	106	6	6	1182		3350	8600	270	330	NJ18/1120EM	1143	1175	1210	1337		5	5	330
1180	1420	106	6	6	1242		2950	7750	250	320	NJ18/1180EM	1203	1228	1270	1397		5		354
	1540	206	7.5	7.5	1258		8950	21500	180	220	NU29/1180EM	1208	1250	1266	1512		6	6	1046
	1540	272	7.5	7.5		1466	11000	28500	190	250	N39/1180M	1208	1458		1512	1474	6	6	1350
1200	1520	185	7.5	7.5	1289		6220	17000	110	140	NU6/1200	1240	1274	1304	1480		6	6	825
1250	1500	112	6	6	1316		3630	9550	300	380	NU18/1250	1280	1306	1326	1470		5	5	386
	1750	290	9.5	9.5		1635	12500	29500	165	190	N20/1250M	1284	1625		1716	1650	8	8	2310
1320	1600	122	6	6	1395		3650	9500	190	250	NU18/1320M	1343	1382	1403	1577		5	5	525
	1720	175	7.5	7.5	1425		7920	19500	190	240	NU19/1320	1348	1406	1428	1692		6	6	1110
	1720	230	7.5	7.5	1420		10900	29000	180	230	NU29/1320E	1348	1405	1430	1692		6	6	1510
	1720	300	7.5	7.5		1640	12600	32500	175	210	N39/1320M	1348	1630		1692	1655	6	6	1890
1400	1700	175	7.5	7.5		1637	6300	18400	175	210	N28/1400EM	1428	1627		1672	1647	6	6	858
1500	1820	140	7.5	7.5	1585		6220	17300	195	250	NU18/1500/HC	1528	1570	1748	1792		6	6	773



Basic dimensions				Basic load ratings		Limit speed		Designations	Other dimensions				Contact surface and chamfer dimensions			Calculation factor				Weight
d	D	B	rsmin	Cr	Cor	Grease	Oil		d2	D1	b	k	da	Da	ra	e	y1	y2	y0	
mm				KN		r/min			mm				mm							Kg
40	80	23	1.1	91.7	85.5	6000	7500	22208C/W33	50.4	68.9	5.5	2	47	73	1	0.28	2.40	3.50	2.50	0.523
	90	33	1.5	143	133	4500	5600	22308CA/W33	56	74	5.5	2.5	49	81	1.5	0.39	1.73	2.58	1.69	1.01
	90	33	1.5	143	133	4500	5600	22308C/W33	56	74	5.5	2.5	49	81	1.5	0.38	1.80	2.70	1.80	1.01
45	85	23	1.1	97	93.5	5300	6700	22209CA/W33	57.6	73	5.5	2	52	78	1	0.28	2.40	3.50	2.50	0.629
	100	36	1.5	174	174	3800	4800	22309C/W33	57.4	81.4	5.5	2.5	54	91	1.5	0.26	2.60	3.90	2.50	1.51
	100	36	1.5	174	174	3800	4800	22309CA/W33	63	81.4	5.5	2.5	54	91	1.5	0.38	1.80	2.60	1.70	1.52
50	90	23	1.1	98.8	103	5000	6300	22210CA/W33	62.2	81.6	5.5	2	57	83	1	0.26	2.60	3.90	2.50	0.630
	110	40	2	209	213	3400	4300	22310C/W33	62.9	90.6	5.5	2.5	61	100	2	0.38	1.80	2.70	1.80	1.96
	110	40	2	209	213	3400	4300	22310CA/W33	69	90.6	5.5	2.5	60	100	2	0.38	1.80	2.60	1.70	2.17
55	100	25	1.5	119	120	4500	5600	22211CA/W33	68.8	87.3	5.5	2	64	91	1.5	0.25	2.70	4.00	2.60	0.887
	100	25	1.5	119	121	4500	5600	22211C/W33	65.7	87.3	5.5	2	62	91	1.5	0.24	2.80	4.20	2.80	0.856
	120	43	2	257	266	3200	4000	22311C/W33	69	99.5	5.5	2.5	65	110	2	0.37	1.90	2.90	1.80	2.37
	120	43	2	257	266	3200	4000	22311CA/W33	75	99.5	5.5	2.5	65	110	2	0.37	1.80	2.70	1.80	2.60
60	110	28	1.5	148	158	4000	5000	22212CA/W33	75.2	95	5.5	2	69	101	1.5	0.24	2.80	4.20	2.80	1.01
	110	28	1.5	148	158	4300	5300	22212C/W33	75.5	95	5.5	2	69	101	1.5	0.24	2.80	4.20	2.80	1.11
	130	31	2.1	201	228	3400	4300	21312C/W33	87.8	115	5.5	3	72	118	2	0.22	3.00	4.60	2.80	2.08
	130	46	2.1	295	318	2800	3600	22312C/W33	81.4	108	5.5	3	72	118	2	0.37	1.90	2.90	1.80	3.25
	130	46	2.1	295	318	3000	3800	22312CA/W33	81.4	108	5.5	3	72	118	2	0.37	1.80	2.70	1.80	3.33
65	120	31	1.5	183	205	3800	4800	22213CA/W33	81.5	103	5.5	2.5	74	111	1.5	0.25	2.70	4.00	2.50	1.56
	120	31	1.5	183	205	3800	4800	22213C/W33	81.5	103	5.5	2.5	74	111	1.5	0.25	2.70	4.00	2.50	1.55
	140	48	2.1	323	342	2600	3400	22313C/W33	88.6	116	5.5	3	77	128	2	0.35	1.90	2.90	1.80	4.92
	140	48	2.1	323	342	2600	3400	22313CA/W33	88.6	116	5.5	3	77	128	2	0.35	1.90	2.90	1.80	4.92
70	125	31	1.5	198	217	3600	4500	22214CA/W33	86.8	109	6	2.5	79	116	1.5	0.24	3.00	4.60	2.80	1.83
	125	31	1.5	198	217	3600	4500	22214C/W33	86.8	109	6	2.5	79	116	1.5	0.24	3.00	4.60	2.80	1.63
	150	51	2.1	380	408	2200	3000	22314C/W33	95.8	125	8.3	4	82	138	2	0.35	1.90	2.90	1.80	4.48
	150	51	2.1	380	408	2200	3000	22314CA/W33	95.8	125	8.3	4	82	138	2	0.35	1.90	2.90	1.80	5.23
75	115	40	1.1	164	220	2900	3500	24015CA/W33	87.5	100	5.5	3	82	106	1	0.32	2.09	3.11	2.04	1.48
	130	31	1.5	201	228	3400	4300	22215CA/W33	92	114	5.5	2.5	84	121	1.5	0.24	3.00	4.60	2.80	1.71
	130	31	1.5	201	228	3400	4300	22215C/W33	92	114	5.5	2.5	84	121	1.5	0.24	3.00	4.60	2.80	1.71
	160	55	2.1	418	451	2200	3000	22315C/W33	101	133	8.3	4	87	148	2	0.35	1.90	2.90	1.80	5.39



Basic dimensions				Basic load ratings		Limit speed		Designations	Other dimensions				Contact surface and chamfer dimensions			Calculation factor				Weight
d	D	B	rsmin	Cr	Cor	Grease	Oil		d2	D1	b	k	da	Da	ra	e	y1	y2	y0	
mm				KN		r/min			mm				mm							Kg
	160	55	2.1	418	451	2200	3000	22315CA/W33	101	133	8.3	4	87	148	2	0.35	1.90	2.90	1.80	5.44
80	140	33	2	224	257	3200	4000	22216C/W33	95.1	122	5.5	2.5	91	129	2	0.22	3.00	4.60	2.80	2.10
	140	33	2	224	257	3200	4000	22216CA/W33	98.9	122	5.5	2.5	91	129	2	0.24	2.80	4.20	2.80	2.08
	170	58	2.1	466	513	2000	2800	22316C/W33	109	142	8.3	4	92	158	2	0.34	1.90	2.90	1.80	6.60
	170	58	2.1	466	513	2000	2800	22316CA/W33	109	142	8.3	4	92	158	2	0.34	1.99	2.96	1.94	7.47
85	150	36	2	271	309	2800	3600	22217C/W33	105	132	6.5	3	96	139	2	0.23	3.00	4.60	2.80	2.73
	150	36	2	271	309	3000	3800	22217CA/W33	105	132	6.5	3	96	139	2	0.24	2.80	4.20	2.80	2.69
	180	41	3	309	356	2000	2800	21317CA/W33	118	152			99	166	2.5	0.24	2.80	4.20	2.80	5.42
	180	60	3	523	589	1900	2600	22317C/W33	107	150	8.3	4	99	166	2.5	0.33	2.00	3.00	2.00	7.38
	180	60	3	523	589	1900	2600	22317CA/W33	115	150	8.3	4	99	166	2.5	0.34	1.99	2.96	1.94	8.19
90	140	50	1.5	233	390	2600	3400	24018CA/W33	106	121	5.5	3	100	125	1.5	0.33	2.00	3.00	2.00	3.25
	160	40	2	309	356	2600	3400	22218C/W33	106	139	8.3	2.5	101	149	2	0.23	2.80	4.20	2.80	4.50
	160	40	2	309	356	2600	3400	22218CA/W33	111	139	8.3	2.5	101	149	2	0.25	2.70	4.00	2.60	3.40
	160	52.4	2	337	418	1900	2600	23218CA/W33	112	136	5.5	2.5	101	149	2	0.25	2.70	4.00	2.60	4.82
	190	64	3	580	660	1800	2400	22318C/W33	113	159	8.3	5	104	176	2.5	0.35	2.00	3.00	2.00	10.1
	190	64	3	580	660	1800	2400	22318CA/W33	123	159	8.3	5	104	176	2.5	0.34	1.99	2.96	1.94	11.5
	190	43	3	580	660	2400	3200	21318CA/W33	112	150	8.3	4.5	104	176	2.5	0.24	2.80	4.20	2.80	5.82
95	170	43	2.1	361	428	2400	3200	22219C/W33	114	148	8.3	3	107	158	2	0.24	2.80	4.20	2.80	4.16
	170	43	2.1	361	428	2400	3200	22219CA/W33	119	148	8.3	3	107	158	2	0.24	2.80	4.20	2.80	4.68
	200	45	3	404	466	2400	3200	21319CA/W33	112	150	8.3	4.5	107	158	2	0.24	2.80	4.20	2.80	7.48
	200	67	3	637	727	1800	2400	22319C/W33	128	167	8.3	5	109	186	2.5	0.34	2.00	3.00	2.00	10.2
	200	67	3	637	727	1800	2400	22319CA/W33	128	167	8.3	5	109	186	2.5	0.34	1.99	2.96	1.94	10.5
100	150	37	1.5	206	325	2400	3200	23020C/W33	116	135	5.5	3	110	140	2	0.22	2.90	4.40	2.80	2.21
	150	50	1.5	271	394	2400	3200	24020CA/W33	115	133	5.5	3	110	140	2	0.30	2.25	3.35	2.20	3.18
	165	52	2	347	466	2000	2800	23120CA/W33	121	143	5.5	3	110	155	2	0.30	2.90	4.40	2.80	4.42
	165	52	2	347	466	2000	2800	23120C/W33	121	143	5.5	3	110	155	2	0.30	2.30	3.40	2.20	4.43
	180	46	2.1	404	466	2200	3000	22220C/W33	124	156	8.3	3	112	168	2	0.24	2.80	4.20	2.80	5.30
	180	46	2.1	404	466	2200	3000	22220CA/W33	124	156	8.3	3	112	168	2	0.24	2.80	4.20	2.80	5.18
	180	60.3	2.1	451	570	1700	2200	23220CA/W33	125	153	9.5	4	112	168	2	0.33	2.00	3.00	2.00	6.58
	215	73	3	774	903	1700	2200	22320C/W33	138	179	11.1	5	114	201	2.5	0.35	2.00	3.00	2.00	13.1
	215	73	3	774	903	1700	2200	22320CA/W33	138	179	11.1	5	114	201	2.5	0.35	1.90	2.90	1.80	13.8



Basic dimensions				Basic load ratings		Limit speed		Designations	Other dimensions				Contact surface and chamfer dimensions			Calculation factor				Weight
d	D	B	rsmin	Cr	Cor	Grease	Oil		d2	D1	b	k	da	Da	ra	e	y1	y2	y0	
mm				KN		r/min			mm				mm							Kg
105	175	56	2	402	550	1900	2700	23121CA/W33	127	151	5.5	3	115	165	2	0.31	2.20	3.30	2.20	5.35
	175	56	2	365	560	1900	2700	23121C/W33	127	151	5.5	3	115	165	2	0.30	2.20	3.30	2.20	5.36
110	170	45	2	295	418	2200	3000	23022CA/W33	128	150	7.5	3	120	160	2	0.25	2.70	4.00	2.60	3.54
	170	45	2	295	418	2200	3000	23022C/W33	128	150	7.5	3	120	160	2	0.24	2.90	4.40	2.80	3.68
	170	60	2	394	589	2100	2800	24022CA/W33	128	150	5.5	3	120	160	2	0.32	2.09	3.11	2.04	4.98
	180	56	2	409	556	1900	2600	23122C/W33	132	156	5.5	3	120	170	2	0.30	2.30	3.40	2.20	5.69
	180	56	2	409	580	1900	2600	23122CA/W33	132	156	5.5	3	120	170	2					573
	180	69	2	494	713	1000	1400	24122CA/W33	131	153	5.5	2.5	120	170	2	0.35	1.90	2.90	1.80	6.92
	200	53	2.1	530	610	2000	2800	22222C/W33	133	173	8.3	4	122	188	2	0.26	2.70	4.00	2.50	7.32
	200	53	2.1	530	610	2000	2800	22222CA/W33	139	173	8.3	4	122	188	2	0.26	2.60	3.90	2.50	7.43
	200	69.8	2.1	570	727	1600	2000	23222CA/W33	138	168	12	5	122	188	2	0.34	1.99	2.96	1.94	10.1
	200	69.8	2.1	570	720	1700	2200	23222/W33	139	168	12	5	122	188	2	0.35	1.90	2.90	1.80	9.54
	240	50	3	420	490	1600	2000	21322CA/W33	150	202	7.5	3								11.7
	240	80	3	900	727	1600	2000	22322C/W33	151	197	13.9	6	122	188	2.5	0.34	2.20	3.30	2.20	17.9
	240	80	3	900	1060	1600	2000	22322CA/W33	151	197	13.9	6	122	188	2.5	0.31	2.20	3.30	2.20	18.9
120	180	46	2	340	495	2000	2800	23024CA/W33	139	162	5.5	3	130	170	2	0.23	2.90	4.40	2.80	4.44
	180	60	2	410	640	1600	2000	24024CA/W33	139	158	5.5	4	130	170	2	0.31	2.20	3.30	2.20	5.83
	200	62	2	490	660	1800	2400	23124CA/W33	146	174	5.5	3	130	190	2	0.30	2.30	3.40	2.20	12.4
	200	62	2	490	660	1800	2400	23124C/W33	146	174	5.5	3	130	190	2	0.29	2.40	3.60	2.50	7.97
	200	80	2	623	900	1400	1800	24124CA/W33	146	167	5.5	3	130	190	2	0.30	2.30	3.40	2.20	10.6
	215	58	2.1	600	730	1900	2600	22224C/W33	149	187	11.1	4	132	203	2	0.25	2.60	3.90	2.50	9.78
	215	58	2.1	600	730	1900	2600	22224CA/W33	149	187	11.1	4	132	203	2	0.26	2.60	3.90	2.50	9.53
	215	76	2.1	660	880	1500	1900	23224CA/W33	150	182	8.3	5	132	203	2	0.35	1.90	2.90	1.80	12.1
	260	86	3	920	1060	1400	1800	22324C/W33	165	218	13.9	6	134	246	2.5	0.35	1.90	2.90	1.80	23.8
	260	86	3	920	1060	1400	1800	22324CA/W33	165	215	13.9	6	134	246	2.5	0.34	1.99	2.96	1.94	23.3
130	200	52	2	410	580	1900	2600	23026CA/W33	153	179	9.5	4	140	190	2	0.24	2.80	4.20	2.80	7.04
	200	52	2	410	580	1900	2600	23026C/W33	153	179	9.5	4	140	190	2	0.24	2.90	4.40	2.80	5.72
	200	69	2	510	770	1800	2400	24026CA/W33	151	175	5.5	3	140	190	2	0.32	2.09	3.11	2.04	7.76
	210	64	2	530	740	1700	2200	23126C/W33	156	183	8.3	4	140	200	2	0.28	2.40	3.50	2.50	9.56
	210	64	2	530	740	1700	2200	23126CA/W33	156	183	8.3	4	140	200	2	0.28	2.40	3.50	2.50	10.7
	210	80	2	650	950	1700	2200	24126CA/W33	153	180	8.3	4	140	200	2	0.35	1.90	2.90	1.80	10.6
	230	64	3	700	880	1800	2400	22226C/W33	162	200	10	5	144	216	2.5	0.26	2.50	3.70	2.50	11.5
	230	64	3	700	880	1800	2400	22226CA/W33	162	200	10	5	144	216	2.5	0.27	2.50	3.70	2.50	12.4
	230	80	3	740	1010	1300	1700	23226CA/W33	161	194	12	5	144	216	2.5	0.33	2.00	3.00	2.00	15.9



Basic dimensions				Basic load ratings		Limit speed		Designations	Other dimensions				Contact surface and chamfer dimensions			Calculation factor				Weight
d	D	B	rsmin	Cr	Cor	Grease	Oil		d2	D1	b	k	da	Da	ra	e	y1	y2	y0	
mm				KN		r/min			mm				mm							Kg
	280	93	4	1060	1250	1300	1700	22326C/W33	178	232	16.7	6	148	262	3	0.34	1.90	2.90	1.80	24.8
	280	93	4	1060	1250	1300	1700	22326CA/W33	178	232	16.7	6	148	262	3	0.34	1.99	2.96	1.94	18.3
140	210	53	2	440	650	1800	2400	23028CA/W33	162	188	8.3	4.5	150	200	2	0.23	2.90	4.40	2.80	6.70
	210	53	2	440	650	1800	2400	23028C/W33	162	188	8.3	4.5	150	200	2	0.22	3.00	4.60	2.80	6.31
	210	69	2	540	860	1800	2400	24028CA/W33	162	188	5.5	3	150	200	2	0.30	2.30	3.40	2.20	8.31
	225	68	2.1	600	860	1600	2000	23128CA/W33	166	196	8.3	5	152	213	2	0.29	2.30	3.50	2.40	10.9
	225	68	2.1	600	860	1600	2000	23128C/W33	166	196	8.3	5	152	213	2	0.28	2.40	3.60	2.50	10.7
	225	85	2.1	730	1100	850	1100	24128CA/W33	165	192	8.3	4.5	152	213	2	0.37	1.80	2.70	1.80	13.4
	250	68	3	670	860	1700	2200	22228CA/W33	176	218	11.1	5	154	236	2.5	0.26	2.60	3.90	2.50	16.2
	250	68	3	670	860	1700	2200	22228C/W33	176	218	11.1	5	154	236	2.5	0.26	2.60	3.90	2.50	14.5
	250	88	3	870	1190	1200	1600	23228CA/W33	173	215	15	6	154	236	2.5	0.33	2.00	3.00	2.00	19.7
	300	102	3.7	1230	1480	1100	1500	22328C/W33	191	249	16.7	7	158	282	3	0.34	1.90	2.90	1.80	35.2
	300	102	4	1230	1480	1100	1500	22328CA/W33	191	249	16.7	7	158	282	3	0.35	1.90	2.90	1.80	36.2
150	225	56	2.1	485	710	1700	2200	23030C/W33	174	201	8.3	4.5	162	213	2	0.22	3.00	4.60	2.80	7.82
	225	56	2.1	485	710	1700	2200	23030CA/W33	174	201	8.3	4.5	162	213	2	0.22	3.00	4.60	2.80	8.01
	225	75	2.1	620	990	1300	1700	24030CA/W33	175	196	5.5	3	162	213	2	0.31	2.20	3.30	2.20	9.39
	250	80	2.1	790	1140	1400	1800	23130C/W33	173	216	11.1	5	162	238	2	0.30	2.30	3.40	2.20	16.2
	250	80	2.1	790	1140	1400	1800	23130CA/W33	182	216	11.1	5	162	238	2	0.30	2.30	3.40	2.20	16.5
	250	100	2.1	970	1450	800	1000	24130CA/W33	180	208	8.3	4.5	162	238	2	0.37	1.80	2.70	1.80	19.2
	270	73	3	810	1030	1600	2000	22230C/W33	179	234	12	6	164	256	2.5	0.26	2.60	3.90	2.50	18.6
	270	73	3	810	1030	1600	2000	22230CA/W33	189	234	12	6	164	256	2.5	0.26	2.60	3.90	2.50	18.7
	270	96	3	1030	1390	1100	1500	23230CA/W33	188	228	11.1	6	164	256	2.5	0.35	1.90	2.90	1.80	26.6
	320	108	4	1390	1670	1000	1400	22330CA/W33	203	265	16.7	9	168	302	3	0.36	1.87	2.79	1.83	41.5
160	240	60	2.1	555	840	1700	2200	23032C/W33	180	216	11.1	4	172	228	2	0.22	3.00	4.60	2.80	8.86
	240	60	2.1	555	840	1700	2200	23032CA/W33	186	216	8.3	5	172	228	2	0.22	3.00	4.60	2.80	10.0
	240	80	2.1	710	1140	1100	1500	24032CA/W33	183	209	8.3	5	172	228	2	0.30	2.30	3.40	2.20	13.2
	270	86	2.1	930	1300	1300	1700	23132CA/W33	188	234	13.9	6	172	258	2	0.30	2.30	3.40	2.20	21.9
	270	86	2.1	930	1300	1300	1700	23132C/W33	188	234	13.9	6	172	258	2	0.30	2.30	3.40	2.20	21.9
	270	86	2.1	930	1300	1300	1700	23132/W33	193	231	13.9	6	172	258	2					21
	270	86	2.1	930	1300	1300	1700	23132C/W33	193	231	13.9	6	172	258	2	0.34	1.99	2.96	1.94	22.2
	270	109	2.1	1120	1670	1200	1600	24132CA/W33	193	225	8.3	4	172	258	2	0.40	1.69	2.51	1.65	24.6
	270	109	2.1	1120	1670	1200	1600	24132C/W33	193	225	8.3	4	172	258	2	0.40	1.69	2.51	1.65	24.8
	290	80	3	960	1230	1200	1500	22232C/W33	201	249	13.9	5	174	276	2.5	0.27	2.50	3.70	2.50	22.8
	290	104	3	1160	1580	1000	1400	23232C/W33	201	244	13.9	7	174	276	2.5	0.35	1.90	2.90	1.80	30.0





Basic dimensions				Basic load ratings		Limit speed		Designations	Other dimensions				Contact surface and chamfer dimensions			Calculation factor				Weight
d	D	B	r <sub>sm</sub>	Cr	Cor	Grease	Oil		d <sub>2</sub>	D <sub>1</sub>	b	k	d <sub>a</sub>	D <sub>a</sub>	r <sub>a</sub>	e	y <sub>1</sub>	y <sub>2</sub>	y <sub>0</sub>	
mm				KN		r/min			mm				mm							Kg
	290	104	3	1160	1580	1000	1400	23232CA/W33	189	244	13.9	7	174	276	2.5	0.35	1.90	2.90	1.80	30.2
	340	114	4	1520	1860	950	1300	22332C/W33	189	284	16.7	7	178	322	3	0.35	1.90	2.90	1.80	51.6
	340	114	4	1520	1860	950	1300	22332CA/W33	201	284	16.7	7	178	322	3	0.35	1.90	2.90	1.80	51.6
170	260	67	2.1	670	1000	1600	2000	23034CA/W33	198	231	11.1	5	182	248	2	0.23	2.90	4.40	2.80	14.1
	260	67	2.1	670	1000	1600	2000	23034C/W33	192	231	11.1	5	182	248	2	0.23	2.90	4.40	2.80	13.6
	260	90	2.1	885	1390	1000	1400	24034CA/W33	198	227	8.3	4	182	248	2	0.33	2.00	3.00	2.00	17.8
	280	88	2.1	990	1450	1200	1600	23134C/W33	190	243	13.9	6	182	268	2	0.30	2.30	3.40	2.20	21.4
	280	109	2.1	1160	1770	1200	1600	24134CA/W33	203	237	8.3	5	182	268	2	0.37	1.80	2.70	1.80	24.8
	310	86	4	1060	1390	1300	1700	22234CA/W33	215	268	16.7	6	188	292	3	0.27	2.50	3.70	2.50	26.8
	310	86	4	1060	1390	1300	1700	22234C/W33	215	268	16.7	6	188	292	3	0.27	2.50	3.70	2.50	29.2
	310	110	4	1330	1830	1000	1300	23234CA/W33	214	261	13.9	7	188	292	3	0.34	1.99	2.96	1.94	37.7
	360	120	4	1670	2050	950	1200	22334CA/W33	231	299	16.7	7	188	342	3	0.34	1.99	2.96	1.94	62.6
	180	250	52	2	410	790	1700	2200	23936CA/W33	204	230	9.5	4	190	240	2	0.18	3.80	5.60	3.60
280		74	2.1	790	1190	1400	1800	23036CA/W33	214	247	13.9	7.5	192	268	2	0.25	2.70	4.00	2.60	17.7
280		74	2.1	790	1190	1400	1800	23036C/W33	214	247	13.9	7.5	192	268	2	0.25	2.70	4.00	2.60	17.1
280		100	2.1	1030	1640	1200	1300	24036CA/W33	210	242	8.3	4	192	268	2	0.33	2.00	3.00	2.00	26.6
300		96	3	1140	1670	1100	1500	23136CA/W33	216	259	13.9	6	194	286	2.5	0.30	2.30	3.40	2.20	27.1
300		96	3	1140	1670	1100	1500	23136C/W33	216	259	13.9	6	194	286	2.5	0.30	2.30	3.40	2.20	26.3
300		118	3	1330	2050	950	1300	24136CA/W33	212	252	11.1	6	194	286	2.5	0.37	1.80	2.70	1.80	33.0
320		86	4	1120	1480	1300	1700	22236CA/W33	224	278	16.7	6	198	302	3	0.26	2.60	3.90	2.50	29.4
320		86	4	1120	1480	1300	1700	22236C/W33	224	278	16.7	6	198	302	3	0.26	2.60	3.90	2.50	29.9
320		112	4	1430	2010	900	1200	23236CA/W33	222	271			198	302	3	0.35	1.90	2.90	1.80	38.7
380		126	4	1900	2330	900	1200	22336CA/W33	242	316	22.3	8	198	362	3	0.34	1.99	2.96	1.94	72.2
380		126	4	1900	2330	900	1200	22336C/W33	242	316	22.3	8	198	362	3	0.34	1.99	2.96	1.94	69.6
190		260	52	2	390	760	1600	2000	23938CA/W33	213	238	5.5	3	202	248	2	0.18	3.80	5.60	3.60
	290	75	2.1	820	1270	1300	1700	23038CA/W33	224	259	13.9	5	202	278	2	0.23	2.90	4.40	2.80	17.3
	290	100	2.1	1060	1710	950	1300	24038CA/W33	219	252			202	278	2	0.31	2.20	3.30	2.20	22.9
	320	104	3	1300	1980	1000	1400	23138CA/W33	232	276	13.9	7	204	306	2.5	0.31	2.20	3.30	2.20	34.3
	320	128	3	1520	2380	800	1200	24138CA/W33	226	267	11.1	6	204	306	2.5	0.40	1.69	2.51	1.65	41.9
	340	92	4	1210	1620	1200	1600	22238CA/W33	235	293			208	322	3	0.26	2.60	3.90	2.50	37.4
	340	92	4	1210	1620	1200	1600	22238C/W33	235	293	16.7	6	208	322	3	0.26	2.60	3.90	2.50	37.9
	340	120	4	1580	2280	850	1100	23238CA/W33	237	288	16.7	7	208	322	3	0.35	1.90	2.90	1.80	44.8
	400	132	5	2010	2520	850	1100	22338CA/W33	257	334	22.3	8	212	378	4	0.34	1.99	2.96	1.94	82.2
	400	132	5	2010	2520	850	1100	22338C/W33	257	334	22.3	8	212	378	4	0.34	1.99	2.96	1.94	81.9



Basic dimensions				Basic load ratings		Limit speed		Designations	Other dimensions				Contact surface and chamfer dimensions			Calculation factor				Weight
d	D	B	r <sub>sm</sub>	Cr	Cor	Grease	Oil		d <sub>2</sub>	D <sub>1</sub>	b	k	d <sub>a</sub>	D <sub>a</sub>	r <sub>a</sub>	e	y <sub>1</sub>	y <sub>2</sub>	y <sub>0</sub>	
mm				KN		r/min			mm				mm							Kg
200	280	60	2.1	520	990	1600	2000	23940CA/W33	226	254	9.5	4	212	268	2	0.19	3.61	5.38	3.53	12.1
	310	82	2.1	950	1450	1200	1600	23040CA/W33	237	276	13.9	7.5	212	298	2	0.25	2.70	4.00	2.60	22.6
	310	82	2.1	950	1450	1200	1600	23040C/W33	237	276	13.9	7.5	212	298	2	0.25	2.70	4.00	2.60	23.3
	310	109	2.1	1230	2010	1000	1200	24040CA/W33	233	268	11.1	5	212	298	2	0.33	2.00	3.00	2.00	31.3
	340	112	3	1520	2240	950	1300	23140CA/W33	243	292	16.7	7	214	326	2.5	0.31	2.20	3.30	2.20	43.8
	340	140	3	1710	2660	900	1000	24140CA/W33	242	283	11.1	6	214	326	2.5	0.40	1.70	2.50	1.60	52.1
	360	98	4	1390	1830	1100	1500	22240CA/W33	250	309	16.7	6	218	342	3	0.26	2.60	3.90	2.50	44.7
	360	128	4	1770	2570	850	1100	23240CA/W33	249	304	16.7	8	218	342	3	0.35	1.90	2.90	1.80	53.4
	420	138	5	2200	2760	850	1100	22340CA/W33	269	350			222	398	4	0.34	1.99	2.96	1.94	96.7
	420	138	5	2200	2760	850	1100	22340C/W33	269	350	22.3	8	222	398	4	0.34	1.99	2.96	1.94	92
220	300	60	2.1	520	1030	1500	1900	23944CA/W33	242	278	8.3	4	232	288	2	0.18	3.80	5.60	3.60	12.9
	340	90	3	1160	1770	1100	1500	23044CA/W33	260	303	13.9	6	234	326	2.5	0.24	2.80	4.20	2.80	32
	340	118	3	1480	2470	850	1100	24044CA/W33	257	295	11.1	5	234	326	2.5	0.33	2.00	3.00	2.00	39.1
	370	120	4	1710	2610	900	1200	23144CA/W33	268	320	16.7	7	238	352	3	0.30	2.30	3.40	2.20	54.7
	370	120	4	1730	2610	900	1200	22244CA/W33	268	320	16.7	7	238	352	3	0.30	2.30	3.40	2.20	54.7
	370	150	4	2010	3180	800	1000	24144CA/W33	262	308	11.1	6	238	352	3	0.40	1.70	2.50	1.60	66.4
	400	108	4	1670	2240	950	1300	22244CA/W33	275	344	16.7	8	238	382	3	0.27	2.50	3.70	2.50	63.5
	400	144	4	2240	3280	900	1100	23244CA/W33	272.5	334	16.7	8	238	382	3	0.36	1.89	2.81	1.85	77.3
	460	145	5	2570	3280	850	1000	22344CA/W33	293.5	384.5	22.3	12	246	422	4	0.32	2.09	3.11	2.04	119
	240	320	60	2.1	535	1100	1300	1700	23948CA/W33	266	295	9.5	4	252	308	2	0.15	4.50	6.70	4.50
360		92	3	1230	1980	1000	1400	23048CA/W33	278	322	13.9	6	254	346	2.5	0.24	2.80	4.20	2.80	34
400		128	4	1980	3040	850	1100	23148CA/W33	289	345	16.7	8	258	382	3	0.31	2.21	3.29	2.16	68.2
400		128	4	1980	3040	850	1100	23148C/W33	289	345	16.7	8	258	382	3	0.31	2.21	3.29	2.16	64.8
400		160	4	2280	3705	480	600	24148CA/W33	285	336	11.1	6	258	382	3	0.40	1.70	2.50	1.60	79
440		120	4	2090	2850	900	1200	22248CA/W33	290	383	18	7	258	422	3	0.27	2.50	3.70	2.50	85.3
440		160	4	2950	3800	670	850	23248CA/W33	292	369	22.3	8	258	422	3	0.35	1.90	2.90	1.80	102
500		155	5	2950	3800	650	800	22348CA/W33	330	390	22.3	12	297	439	4	0.32	2.09	3.11	2.04	148
250	360	75	2.1	902	1750	1100	1500	23952CA/W33	294	328	12	6	272	348	2	0.18	3.80	5.60	3.60	21.6
260	360	75	2.1	836	1710	1100	1500	23952CA/W33	287	331	8.3	4.5	271	348	2	0.18	3.80	5.60	3.60	24.3
	400	104	4	1520	2420	900	1200	23052CA/W33	306	357	16.7	7	278	382	3	0.23	2.90	4.40	2.80	49.8
	400	104	4	1520	2420	900	1200	23052C/W33	306	357	16.7	7	278	382	3	0.23	2.90	4.40	2.80	47.8
	400	140	4	1940	3280	700	900	24052CA/W33	300	347	11.1	6	278	382	3	0.33	2.00	3.00	2.00	66.7
	440	144	4	2420	3700	800	1000	23152CA/W33	310	379	16.7	9	278	422	3	0.31	2.20	3.30	2.20	88.9



Basic dimensions				Basic load ratings		Limit speed		Designations	Other dimensions				Contact surface and chamfer dimensions			Calculation factor				Weight
d	D	B	rsmin	Cr	Cor	Grease	Oil		d2	D1	b	k	da	Da	ra	e	y1	y2	y0	
mm				KN		r/min			mm				mm							Kg
	440	180	4	2850	4560	430	530	24152CA/W33	312	366	13.9	8	278	422	3	0.39	1.73	2.58	1.69	115
	480	130	5	2520	3370	850	1100	22252CA/W33	330	414	22.3	12	282	458	4	0.27	2.51	3.74	2.45	106
	480	174	5	3090	4510	630	800	23252CA/W33	320	404	22.3	8	282	458	4	0.35	1.90	2.90	1.80	141
	540	165	6	3370	4320	630	800	22352CA/W33	349	455	22.3	8	288	512	5	0.31	2.20	3.30	2.20	186
	540	165	6	3370	4320	630	800	22352C/W33	349	455	22.3	8	288	512	5	0.31	2.20	3.30	2.20	185
280	350	52	2	435	1230	1200	1500	23856CA/W33	305	328	8.3	4.5	278	348	2	0.13	5.36	7.98	5.24	11.4
	380	75	2.1	800	1670	1000	1400	23956CA/W33	316	346	12	6	292	368	2	0.18	3.80	5.66	3.72	25.7
	420	106	4	1640	2700	850	1100	23056CA/W33	323	377			298	402	3	0.23	2.91	4.40	2.84	56.8
	420	106	4	1640	2700	850	1100	23056C/W33	323	377	16.7	7	298	402	3	0.23	2.91	4.40	2.84	53.9
	420	140	4	2050	3610	670	850	24056CA/W33	317	366	11.1	6	298	402	3	0.31	2.20	3.30	2.20	69.2
	460	146	5	2520	4040	800	950	23156CA/W33	333	400	16.7	8	302	438	4	0.30	2.30	3.40	2.20	104
	460	180	5	2950	4850	750	950	24156CA/W33	327	388	13.9	8	302	438	4	0.40	1.70	2.50	1.60	119
	500	130	5	2570	3560	800	1000	22256CA/W33	347	435	22.3	8	302	478	4	0.26	2.60	3.90	2.50	118
	500	176	5	3090	4660	630	750	23076CA/W33	340	424			302	478	4	0.35	1.90	2.90	1.80	147
	500	176	5	3090	4660	630	750	23256CA/W33	340	424	22.3	8	302	478	4	0.35	1.90	2.90	1.80	146
	580	175	6	3800	4940	600	750	22356CA/W33	364	485	22.3	8	308	552	5	0.30	2.30	3.40	2.20	221
300	380	60	3	625	1520	950	1400	23860CA/W33	328	357	12	6	310	368	2	0.13	5.20	7.70	5.00	18.2
	420	90	3	1140	2380	950	1300	23960CA/W33	339	382	15	6	314	406	2.5	0.19	3.60	5.30	3.60	40.1
	420	118	3	1140	2380	950	1200	24960CA/W33	339	376	18	7								36.5
	460	118	4	2010	3280	800	1000	23060CA/W33	351	409	16.7	9	318	442	3	0.23	2.90	4.40	2.80	75.8
	460	160	4	2570	4510	600	750	24060CA/W33	342	399	13.9	7	318	442	3	0.32	2.09	3.11	2.04	99
	460	160	4	2570	4510	600	750	24060C/W33	342	399	13.9	7	318	442	3	0.32	2.09	3.11	2.04	97.3
	500	160	5	3040	4850	670	850	23160CA/W33	356	433	16.7	9	322	478	4	0.30	2.30	3.40	2.20	126
	500	200	5	3560	5990	600	750	24160CA/W33	356	420	13.9	6	322	478	4	0.39	1.75	2.61	1.71	161
	540	140	5	3030	4040	750	950	22260CA/W33	374	467			322	518	4	0.26	2.60	3.90	2.50	138
	540	192	5	3700	5560	530	670	23260CA/W33	373	455	22	10	322	518	4	0.35	1.90	2.90	1.80	190
	320	400	60	2.1	670	1620	920	1280	23864CA/W33	346	376	13.9	6	332	388	2	0.12	5.60	8.40	5.60
440		90	3	1360	2570	900	1200	23964CA/W33	360	402	15	6	338	426	2.5	0.18	3.80	5.60	3.60	19.4
480		121	4	2130	3610	800	1000	23064CA/W33	368	431	16.7	8	338	462	3	0.23	2.90	4.40	2.80	84.8
480		160	4	2710	4850	560	700	24064CA/W33	368	421	22	8	338	462	3	0.32	2.09	3.11	2.04	105
480		160	4	2710	4850	560	700	24064C/W33	354	423	22	8	335	465	3	0.32	2.09	3.11	2.04	97.9
540		176	5	3560	5700	630	800	23164CA/W33	389	465	22.3	8	342	518	4	0.31	2.20	3.30	2.20	200
540		210	5	4040	6750	340	430	24164CA/W33	364	455	16.7	9	342	518	4	0.40	1.70	2.50	1.60	206
580		150	5	3420	4660	670	850	22264CA/W33	400	502	22.3	8	342	558	4	0.26	2.60	3.90	2.50	175



Basic dimensions				Basic load ratings		Limit speed		Designations	Other dimensions				Contact surface and chamfer dimensions			Calculation factor				Weight
d	D	B	rsmin	Cr	Cor	Grease	Oil		d2	D1	b	k	da	Da	ra	e	y1	y2	y0	
mm				KN		r/min			mm				mm							Kg
	580	150	5	3420	4660	700	900	22264/W33	400	502	22.3	8	342	558	4	0.27	2.50	3.70	2.50	177
	580	208	5	4180	6370	500	630	23264CA/W33	400	490	24	10	342	558	4	0.35	1.90	2.90	1.80	253
	670	200	7.5	4530	6820	450	600	22364CA/W33	430	566	22.3	12	342	645	6					344
340	460	90	3	1390	2660	900	1200	23968CA/W33	378	423	15	6	354	446	2.5	0.17	4.00	5.90	4.00	46
	520	133	5	2570	4320	700	900	23068CA/W33	400	464	22.3	8	362	498	4	0.24	2.80	4.20	2.80	115
	520	180	5	3280	5890	530	670	24068CA/W33	394	451	16.7	8	362	498	4	0.33	2.00	3.00	2.00	137
	520	180	5	3280	5890	530	670	24068C/W33	377	453	16.7	9	358	502	4	0.33	2.00	3.00	2.00	139
	580	190	5	4040	6460	600	750	23168CA/W33	412	497	22.3	8	362	558	4	0.31	2.20	3.30	2.20	211
	580	243	5	5040	8220	320	400	24168CA/W33	408	486	22.3	10	362	558	4	0.4	1.7	2.5	1.6	261
	620	224	6	4850	7410	430	530	23268CA/W33	426	528			368	592	5	0.35	1.90	2.90	1.80	297
360	480	90	3	1330	2610	850	1100	23972CA/W33	403	441	11.1	6	374	466	2.5	0.16	4.20	6.30	4.00	46.6
	540	134	5	2610	4560	670	850	23072CA/W33	419	486	22.3	8	382	518	4	0.23	2.90	4.40	2.80	126
	540	134	5	2610	4560	670	850	23072C/W33	419	486	22.3	8	382	518	4	0.23	2.90	4.40	2.80	108
	540	180	5	3370	6220	600	750	24072CA/W33	398	474	16.7	8	382	518	4	0.31	2.2	3.3	2.2	150
	600	192	5	4090	6600	560	700	23172CA/W33	434	518	22.3	12	382	578	4	0.30	2.30	3.40	2.20	255
	600	243	5	5320	8840	300	380	24172CA/W33	430	511	20	12	382	578	4	0.37	1.80	2.70	1.80	270
	650	170	6	4090	5890	380	480	22272CA/W33	449	563	22.3	8	388	622	5	0.26	2.60	3.87	2.54	253
	650	232	6	5130	7880	400	500	23272CA/W33	443	547	22.3	10	388	622	5	0.35	1.90	2.90	1.80	335
	750	224	7.5	4900	8600	400	500	22372CA/W33	471	631	22.3	12	392	720	6	0.31	2.21	3.29	2.16	468
380	520	106	4	1860	3610	800	1000	23976CA/W33	426	476	15	10	398	502	3	0.17	4.00	5.90	4.00	69.9
	560	135	5	2760	4750	630	800	23076CA/W33	441	505	22.3	8	402	538	4	0.22	3.00	4.60	2.80	130
	560	180	5	3420	6460	480	600	24076CA/W33	435	494	22	10	402	538	4	0.3	2.3	3.4	2.2	151
	560	180	5	3420	6460	480	600	24076C/W33	435	494	16.7	9	402	538	4	0.3	2.3	3.4	2.2	152
	620	194	5	4180	6750	400	500	23176CA/W33	457	540	22	8	402	598	4	0.30	2.30	3.40	2.20	250
	620	243	5	5420	9310	300	380	24176CA/W33	457	540	22	8	402	598	4	0.30	2.30	3.40	2.20	296
	680	240	6	5560	8690	380	480	23276CA/W33	468	574	22.3	10	408	652	5	0.35	1.90	2.90	1.80	389
400	540	106	4	1900	3700	750	950	23980CA/W33	445	497	15	10	418	522	3	0.17	4.00	5.90	4.00	72.9
	600	148	5	3090	5420	600	750	23080CA/W33	460	538			422	578	4	0.23	2.90	4.40	2.80	161
	600	200	5	4090	7600	450	560	24080CA/W33	458	524	22	12	422	578	4	0.30	2.30	3.40	2.20	203
	650	200	6	4420	7270	380	480	23180CA/W33	480	568	22.3	8	428	622	5	0.28	2.40	3.60	2.50	275
	650	250	6	5890	10070	320	400	24180CA/W33	476	563	22.3	8	428	622	5	0.36	1.87	2.79	1.83	325
	720	256	6	6220	9880	340	430	23280CA/W33	499	606	22	10	428	692	5	0.35	1.90	2.90	1.80	350
	820	243	7.5	7130	9880	340	430	22380CA/W33	520	694	22.3	12	442	790	6	0.31	2.21	3.29	2.16	623



Basic dimensions				Basic load ratings		Limit speed		Designations	Other dimensions				Contact surface and chamfer dimensions			Calculation factor				Weight
d	D	B	rsmin	Cr	Cor	Grease	Oil		d2	D1	b	k	da	Da	ra	e	y1	y2	y0	
mm				KN		r/min			mm				mm							Kg
420	520	75	2.1	950	2630	750	950	23884CA/W33	454	490	13.9	5	430	504	2	0.12	5.60	8.40	5.60	35.9
	560	106	4	1950	3950	700	900	23984CA/W33	464	517	16.7	9	435	545	3	0.16	4.20	6.30	4.00	73.6
	620	150	5	3230	5700	450	560	23084CA/W33	484	558			442	598	4	0.22	3.00	4.60	2.80	150
	620	200	5	4180	7880	380	480	24084CA/W33	479	548	22.3	12	442	598	4	0.30	2.30	3.40	2.20	202
	700	224	6	5320	8800	360	450	23184CA/W33	505	605	22.3	12	448	672	5	0.30	2.30	3.40	2.20	353
	700	280	6	7000	11950	300	380	24184CA/W33	497	599	22.3	12	448	674	5	0.38	1.80	2.60	1.70	436
	760	272	7.5	7000	11000	320	400	23284CA/W33	525	643	22	12	456	724	6	0.35	1.90	2.90	1.80	550
440	600	118	4	2400	4850	450	560	23988CA/W33	492	553	16.7	8	462	578	3	0.17	4.00	5.90	4.00	101
	650	157	6	3470	6220	430	530	23088CA/W33	507	585	22.3	8	468	622	5	0.22	3.00	4.60	2.80	185
	650	212	6	4560	8700	360	450	24088CA/W33	502	569	22.3	12	468	626	5	0.30	2.30	3.40	2.20	251
	720	226	6	5700	9500	340	430	23188CA/W33	522	626	22.3	12	468	692	5	0.30	2.30	3.40	2.20	377
	720	280	6	7130	12500	300	380	24188CA/W33	517	618	22.3	12	468	692	5	0.37	1.80	2.70	1.80	436
	790	280	7.5	7410	11880	320	400	23288CA/W33	548	675	22.3	12	472	578	6	0.35	1.90	2.90	1.80	611
460	580	118	3	1700	4655	450	560	24892CA/W33	504	540	15	6	472	566	2.5	0.17	4.00	5.90	4.00	82
	620	118	4	2370	4750	430	530	23992CA/W33	511	572	16.7	9	475	605	3	0.16	4.20	6.30	4.00	105
	680	163	6	3710	6600	400	500	23092CA/W33	531	613	23.5	12	488	652	5	0.22	3.00	4.60	2.80	229
	680	218	6	4940	9500	340	430	24092CA/W33	528	600	24	12	488	652	5	0.29	2.35	3.50	2.30	304
	760	240	7.5	6080	10260	320	400	23192CA/W33	557	660	22	8	496	724	6	0.30	2.30	3.40	2.20	443
	760	300	7.5	7900	13870	160	200	24192CA/W33	540	639	22.3	8	496	724	6	0.37	1.80	2.70	1.80	461
	830	296	7.5	8100	13000	300	380	23292CAKF3/W33	566	698	22.3	10	496	794	6	0.35	1.90	2.90	1.80	698
	480	600	90	3	1350	3560	450	600	23896CA/W33	523	563			500	580	2.5	0.13	5.36	7.98	5.24
650		128	5	2760	5400	400	500	23996CA/W33	532	596	16.7	10	502	628	4	0.18	3.80	5.60	3.60	126
700		165	6	3700	6450	380	480	23096CA/W33	552	634	22.3	12	504	678	5	0.21	3.20	4.80	3.20	217
700		165	6	3700	6450	400	500	23096F3/W33	553	625	22.3	12	504	678	5	0.23	2.90	4.40	2.80	247
700		218	6	5050	9900	340	430	24096CA/W33	542	618	22.3	12	504	678	5	0.28	2.40	3.60	2.50	296
870		310	7.5	8850	14250	260	340	23296CA/W33	581	732	22.3	12	516	834	6	0.35	1.90	2.90	1.80	853
500		620	90	3	1400	3800	420	520	238/500CA/W33	542	586	16.7	8	512	606	2.5	0.12	5.60	8.40	5.60
	670	128	5	2750	5700	400	500	239/500CA/W33	555	619	22.3	12	522	648	4	0.17	4.00	5.90	4.00	120
	720	167	6	3950	7400	380	480	230/500CA/W33	568	653	22.3	12	528	692	5	0.21	3.20	4.80	3.20	228
	720	218	6	5230	10450	420	520	240/500CA/W33	565	645	22.3	12	523	698	5	0.26	2.60	3.90	2.50	297
	830	264	7.5	7270	12260	320	400	231/500CA/W33	603	726	22.3	12	536	794	6	0.30	2.30	3.40	2.20	588
	830	325	7.5	9310	16150	300	380	241/500CA/W33	588	712	22.3	12	531	798	6	0.37	1.80	2.70	1.80	719



Basic dimensions				Basic load ratings		Limit speed		Designations	Other dimensions				Contact surface and chamfer dimensions			Calculation factor				Weight
d	D	B	rsmin	Cr	Cor	Grease	Oil		d2	D1	b	k	da	Da	ra	e	y1	y2	y0	
mm				KN		r/min			mm				mm							Kg
530	650	118	3	1750	5000	380	480	248/530CA/W33	573	612	22	8	543	636	2.5	0.15	4.50	6.70	4.50	91
	710	136	5	3050	6350	360	450	239/530CA/W33	586	658	22.3	12	548	690	4	0.17	4.00	5.90	4.00	150
	780	185	6	4850	8850	340	430	230/530CA/W33	614	703	24	12	558	752	5	0.22	3.00	4.60	2.80	328
	780	250	6	6370	12550	280	360	240/530CA/W33	605	691	22.3	12	553	758	5	0.29	2.30	3.50	2.40	416
	870	272	7.5	7750	13300	260	340	231/530CA/W33	635	762	22.3	12	560	837	6	0.30	2.30	3.40	2.20	665
	870	335	7.5	10100	18050	190	280	241/530CA/W33	622	748	22.3	12	560	837	6	0.37	1.80	2.80	1.80	846
	980	355	9.5	10500	19300	210	290	232/530CA/W33	656	818	22.3	12	565	932	8	0.36	1.87	2.79	1.83	1220
560	750	140	5	3280	6850	340	430	239/560CA/W33	621	693	22.3	12	582	728	4	0.16	4.20	6.30	4.00	177
	820	195	6	5300	9700	320	410	230/560CA/W33	644	741	22.3	9	588	792	5	0.22	3.14	4.67	3.07	360
	820	258	6	7000	13900	220	300	240/560CA/W33	640	721	22.3	12	585	798	5	0.28	2.40	3.60	2.50	471
	920	280	7.5	8700	15200	240	320	231/560CA/W33	677	803	22.3	12	596	884	6	0.30	2.30	3.40	2.20	756
	920	355	7.5	11400	20500	120	160	241/560CA/W33	634	796	22.3	12	596	884	6	0.37	1.80	2.80	1.80	973
	1030	365	9.5	10900	21000	190	260	232/560CA/W33	705	877	22.3	12	600	990	8	0.35	1.90	2.90	1.80	1380
600	800	150	5	3700	7850	320	400	239/600CA/W33	668	742	22.3	12	622	778	4	0.17	4.00	5.90	4.00	220
	800	200	5	5700	10800	320	400	249/600CAF1/W33	666	728	22.3	12	622	760	4	0.22	3.00	4.60	2.80	287
	870	200	6	5700	10800	300	380	230/600CA/W33	685	787	22.3	9	628	842	5	0.22	3.00	4.60	2.80	431
	870	272	6	7750	16150	220	300	240/600CA/W33	682	770	22.3	12	628	850	5	0.30	2.30	3.40	2.80	551
	870	272	6	7750	16150	240	320	240/600/W33	680	770	22.3	12	628	850	5	0.30	2.30	3.40	2.20	550
	980	300	7.5	9700	17100	180	250	231/600CAF3/W33	717	855	22.3	12	660	996	6	0.29	2.30	3.50	2.40	894
	980	375	7.5	10950	22450	110	150	241/600CA/W33	709	827	22	8	636	944	6	0.36	1.90	2.82	1.85	1151
	1090	388	9.5	12450	24250	190	260	232/600CA/W33	750	920			700	1000	8	0.35	1.93	2.88	1.80	1570
	628	920	212	7.5	5600	12800	260	340	230/628CAF3/W33	721	831	22.3	9	666	884	6	0.21	3.20	4.80	3.20
630	780	112	4	2100	5800	300	380	238/630CAF3/W33	682	738	16.7	9	645	765	3	0.12	5.60	8.40	5.60	124
	820	112	4	2200	6300	270	350	238/670CA/W33	722	778	16.7	9	686	805	3	0.11	6.10	9.10	6.30	136
	820	150	4	3100	9600	270	350	248/670CA/W33	716	771	16.7	9	686	805	3	0.16	4.20	6.30	4.00	315
	850	165	6	4400	9300	280	360	239/630CA/W33	705	786	22.3	12	658	822	5	0.17	4.00	5.90	4.00	220
	920	212	7.5	6400	11900	260	340	230/630CAF3/W33	721	831	22.3	9	666	884	6	0.21	3.20	4.80	3.20	471
	920	290	7.5	7350	17100	220	300	240/630/W33	722	815	22.3	10	666	884	6	0.30	2.30	3.40	2.20	661
	1030	315	7.5	9950	19700	180	250	231/630CA/W33	756	918	22.3	12	668	996	6	0.30	2.30	3.40	2.20	1080
	1030	400	7.5	12100	25700	160	210	241/630CA/W33	736	885	22.3	12	662	996	6	0.37	1.80	2.70	1.80	1440
670	900	170	6	4750	10200	260	340	239/670CAF3/W33	743	831	22.3	12	692	876	5	0.17	4.00	5.90	4.00	313
	980	230	7.5	7300	13390	240	310	230/670CA/W33	760	885	22.3	12	706	944	6	0.22	3.00	4.60	3.20	604



Basic dimensions				Basic load ratings		Limit speed		Designations	Other dimensions				Contact surface and chamfer dimensions			Calculation factor				Weight
d	D	B	r <sub>sm</sub>	Cr	Cor	Grease	Oil		d2	D1	b	k	da	Da	ra	e	y1	y2	y0	
mm				KN		r/min			mm				mm							Kg
	980	308	7.5	9500	19300	190	270	240/670CA/W33	760	866	22.3	12	700	952	6	0.28	2.40	3.60	2.50	807
	1090	336	7.5	10350	21300	175	240	231/670CA/W33	801	958	22.3	12	700	1056	6	0.30	2.30	3.40	2.20	1280
	1090	412	7.5	13100	27500	150	190	241/670CA/W33	786	934	22.3	12	705	1056	6	0.36	1.87	2.79	1.83	1560
	1220	438	12	14650	29000	160	210	232/670CA/W33	832	1027	22.3	12	718	1170	10	0.35	1.90	2.90	1.80	2300
690	990	180	6	5500	11800	220	310	206/690CAF3/W33	780	907	22.3	12	705	975	5	0.16				461
700	950	180	6	5000	11900	220	300	206/700CAF3/W33	780	877	13.3	12	715	935	5	0.16				378
710	870	118	4	2450	7100	260	340	238/710CAF3/W33	761	824	22.3	12	725	855	3	0.11	6.10	9.10	6.30	156
	950	180	6	5300	11400	240	310	239/710CA/W33	787	882	22.3	12	733	927	5	0.17	4.00	5.90	4.00	364
	950	243	6	6450	14800	200	280	249/710CAF1/W33X	791	864	22.3	12	733	927	5	0.22	3.00	4.60	2.80	500
	1030	236	7.5	7900	15500	220	300	230/710CAF3/W33	814	939	22.3	12	746	994	6	0.21	3.20	4.80	3.20	669
	1030	315	7.5	10010	21650	180	250	240/710CA/W33	806	918	22.3	12	738	1002	6	0.27	2.50	3.70	2.50	910
	1150	345	9.8	11600	24700	170	220	231/710CA/W33	851	1016	22.3	12	750	1110	8	0.28	2.40	3.60	2.50	1480
	1150	438	9.5	14450	30900	90	120	241/710CA/W33	838	982	22.3	12	754	1106	8	0.35	1.90	2.90	1.80	1801
	1280	450	12	16700	32700	160	210	232/710CA/W33	876	1096	22.3	12	758	1232	10	0.35	1.90	2.90	1.80	2640
750	920	128	5	2800	8100	240	310	238/750CA/W33	806	873	22.3	12	770	902	4	0.11	6.10	9.10	6.30	188
	920	170	5	3550	11000	220	300	248/750CA/W33	808	864	22.3	12	770	902	4	0.16	4.20	6.30	4.00	253
	1000	185	6	5700	12500	210	290	239/750CA/W33	831	930	22.3	12	772	976	5	0.16	4.20	6.30	4.00	414
	1000	250	6	7300	17100	180	250	249/750CA/W33	830	916	22.3	12	773	976	5	0.22	3.00	4.60	2.80	566
	1090	250	7.5	9200	17700	200	280	230/750CAF3/W33	847	987	22.3	12	786	1054	6	0.21	3.20	4.80	3.20	786
	1090	335	7.5	11200	23750	170	220	240/750CA/W33	852	970	22.3	12	779	1062	6	0.28	2.40	3.60	2.50	1100
	1220	365	9.5	13100	27500	160	210	231/750CA/W33	898	1080	22.3	12	798	1180	8	0.28	2.40	3.60	2.50	1760
	1220	475	9.5	16400	35600	130	170	241/750CA/W33	872	1039	22.3	12	792	1175	8	0.35	1.90	2.90	1.80	2195

# Single Row Angular Contact Ball Bearings

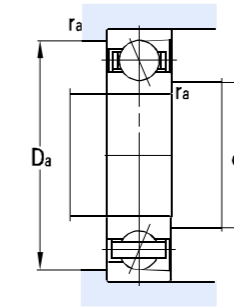
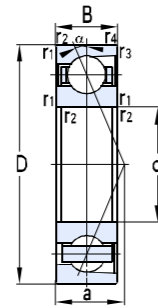

Basic dimensions					Basic load ratings		Limit speed		Designations	Funtion point	Abutment and fillet dimensions			Weight
d	D	B (2B)	r12	r34	Cr	Cor	Grease	Oil		a	da(max)	Da(max)	ra(max)	
mm					KN		r/min				mm			Kg
35	72	17	1.1	1.1	30.5	20.7	8000	11000	7207AC	31	42	65	1	0.304
45	100	25	1.5	0.6	65.0	45.0	6000	8000	7309ACM	29.4	64	91	1.5	1.02
50	90	20	1.1	0.6	40.3	30.0	5800	7800	7210AC	26.3	57	83	1	0.460
	110	27	2	1	71.5	49.0	5600	7500	7310ACM	32.2	60	100	2	1.16
55	90	18	1.1	0.6	31.2	26.0	7500	10000	7011AC	25.9	62	83	1	0.385
	100	21	1.5	0.6	50.7	38.0	7100	10000	7211AC	28.6	64	91	1.5	0.599
	120	29	2	1	88.4	63.0	5000	6700	7311ACM	34.9	65	110	2	1.65
60	130	31	2.1	1.1	94.9	67.0	4800	6300	7312AC	37.7	72	118	2	1.80
65	100	18	1.1	0.6	33.8	31.0	6700	9500	7013AC	28.2	72	93	1	0.414
	120	23	1.5	0.6	73	59.0	5000	6700	7213ACM	50	74	111	1.5	1.18
	130	31	2.1	1.1	105	67.0	4500	6000	7312ACM	55	72	118	2	2.16
	140	33	2.1	1.1	114	84.0	4300	6000	7313ACM	40.4	77	128	2	2.61
70	110	20	1.1	0.6	44.2	41.0	6300	8500	7014ACM	31	77	103	1	0.725
	125	24	1.5	0.6	75.4	62.0	5600	8000	7214ACM	34.7	79	116	1.5	1.26
	150	35	2.1	1.1	129	96.0	4000	5300	7314ACM	43.2	82	138	2	3.01
75	130	25	1.5	0.6	79.3	67.0	5600	7500	7215ACM	36.4	84	121	1.5	1.29
	160	37	2.1	1.1	140	109	3800	5000	7315ACM	45.9	87	148	2	3.57
80	125	22	1.1	0.6	55.9	53.0	4500	6000	7016ACJ	34.9	87	118	1	0.849
	125	22	1.1	0.6	56.5	52.5	5600	7500	7016ACM	40.6	87	118	1	0.997
	140	26	2	1	92.3	79.0	5000	7100	7216ACM	38.7	90	130	2	1.73
	170	39	2.1	1.1	152	122	3600	4800	7316ACM	48.7	92	158	2	4.21
85	130	22	1.1	0.6	57.2	56.0	5300	7100	7017ACM	36.1	92	123	1	1.12
	150	28	2	1	98.8	86.0	4800	6700	7217ACM	41.4	95	140	2	1.72
	180	41	3	1.1	164	137	3400	4500	7317ACM	51.4	99	166	2.5	4.99
90	140	24	1.5	0.6	67.6	66.0	4800	6700	7018ACM	38.8	99	131	1.5	1.39
	160	30	2	1	117	100	4500	6000	7218ACM	44.1	100	150	2	2.35
	190	43	3	1.1	176	152	3200	4300	7318ACM	54.1	104	176	2.5	6.18



# Single Row Angular Contact Ball Bearings

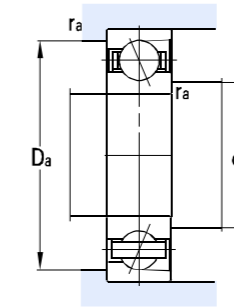
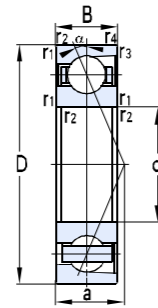

Basic dimensions					Basic load ratings		Limit speed		Designations	Funtion point	Abutment and fillet dimensions			Weight
d	D	B ( 2B )	r12	r34	Cr	Cor	Grease	Oil		a	da(max)	Da(max)	ra(max)	
mm					KN		r/min				mm			Kg
95	170	32	2.1	1.1	133	114	4300	5600	7219ACM	46.9	107	158	2	2.97
100	150	24	1.5	0.6	76.7	77.0	4500	6000	7020AC	41.2	109	141	1.5	1.25
	180	34	2.1	1.1	148	130	4000	5300	7220ACM	49.6	112	168	2	3.74
	200	45	3	1.1	189	167	3000	4000	7319ACM	56.9	109	186	2.5	6.67
	215	47	3	1.1	213	199	2800	3800	7320ACM	60.2	114	201	2.5	9.61
110	170	28	2	1	98.8	101	4000	5300	7022ACM	46.7	120	160	2	2.41
	200	38	2.1	1.1	176	164	3600	4800	7222ACM	55.1	122	188	2	4.81
	240	50	3	1.1	239	231	2600	3400	7322ACM	65.8	124	226	2.5	9.97
120	180	28	2	1	100	107	3600	5000	7024ACM	49	130	170	2	2.62
	215	40	2.1	1.1	190	184	3200	4500	7224ACM	59.1	132	203	2	6.04
	260	55	3	1.1	265	269	2200	3000	7324AC	71.8	134	246	2.5	13.7
130	230	40	3	1.1	196	200	2400	3200	7226ACM	62	144	216	2.5	7.26
140	210	33	2	1	125	137	3200	4300	7028ACM	57.3	150	200	2	4.14
	250	42	3	1.1	220	237	2200	3000	7228ACM	66.5	154	236	2.5	8.71
	300	62	4	1.5	275	300	1600	2200	7328B	123.3	158	282	3	21.2
150	225	35	2.1	1.1	153	170	2400	3000	7030ACM	61.2	162	213	2	4.80
	320	65	4	1.5	359	429	1800	2400	7330AC	87.6	168	302	3	25.8
160	290	48	3	1.1	250	289	1900	2600	7232AC	76.5	174	276	2.5	14.5
180	320	52	4	1.5	317	399	1700	2200	7236AC	84.3	198	302	3	17.9
200	360	58	4	1.5	345	462	1500	2000	7240AC	94.3	218	342	3	25.2
220	400	65	4	1.5	423	605	1100	1600	7244AC	104.7	238	382	3	36.1
1000	1220	100	6	3	830	2460	260	360	718/1000A	370	1023	1197	5	239

# Metric Single Row Tapered Roller Bearings

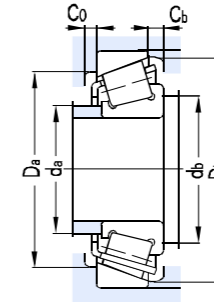
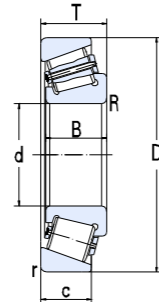
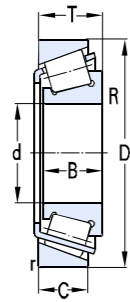

Basic dimensions									Basic load ratings		Limit speed		Designations	Abutment and fillet dimensions						Calculation factor				Weight	
d	D	T	B	C	R <sub>radial</sub>	R <sub>axial</sub>	r <sub>radial</sub>	r <sub>axial</sub>	Cr	Cor	Grease	Oil		d <sub>amax</sub>	d <sub>bmin</sub>	D <sub>amin</sub>	D <sub>amax</sub>	D <sub>bmin</sub>	C <sub>amin</sub>	C <sub>bmin</sub>	e	Y	Y <sub>0</sub>		a
mm									KN		r/min			mm										Kg	
20	47	15.25	14	12	1	1	1	1	27.3	26.9	8000	11000	30204	27	26	40	41	43	2.5	3.3	0.35	1.7	0.96	11	0.121
	47	19.25	18	15	1	1	1	1	27.5	31	7500	10000	32204	26	24	38	43	44	2	4.3	0.33	1.8	1	12	0.158
	52	16.25	15	13	1.5	1.5	1.5	1.5	32.5	22	8000	11000	30304	28	28	44	45	48	3	3.3	0.3	2	1.1	11	0.167
	52	22.25	21	18	1.5	1.5	1.5	1.5	42	35	7500	10000	32304	26	27	43	45	48	3	4.5	0.3	2	1.1	13	0.238
25	47	17	17	14	0.6	0.6	0.6	0.6	32.5	42.5	7500	9500	33005	31	28	40	44	45	2	3	0.29	2.1	1.14	11	0.129
	52	16.25	15	13	1	1	1	1	32	34	7500	9500	30205	31	31	44	46	49	2	3.3	0.37	1.6	0.88	12	0.160
	52	19.25	18	16	1	1	1	1	40.5	46	7000	9500	32205	31	31	44	48	50	2	3.3	0.36	1.7	0.92	13	0.199
	52	22	22	18	1	1	1	1	51.5	56	7500	9500	33205	30	29	42	48	50	2	4	0.35	1.7	0.94	14	0.216
	62	18.25	17	13	1.5	1.5	1.5	1.5	42.5	46	5600	7500	31305	34	32	47	55	59	3	5	0.83	0.72	0.4	20	0.263
	62	18.25	17	13	1.5	1.5	1.5	1.5	48	47	5600	7500	30305	35	32	54	55	58	3	5.3	0.3	2	1.1	12	0.250
	62	25.25	24	20	1.5	1.5	1.5	1.5	63	66	6000	7100	32305	32	32	52	55	58	2	5.3	0.3	2	1.1	15	0.422
28	52	16	16	12	1	1	1	1	35.5	39.2	7100	8900	320/28	33	32	44	48	51	2	4	0.43	1.4	0.77	13	0.145
30	62	17.25	16	14	1	1	1	1	41	44	6300	8500	30206	37	36	53	56	58	3	4.5	0.37	1.6	0.88	14	0.230
	62	21.25	20	17	1	1	1	1	55	65	6300	8500	32206	36	36	52	56	58	2	4.3	0.37	1.6	0.88	15	0.356
	62	25	25	19.5	1	1	1	1	70.5	75	5600	7500	33206	37	34	51	58	60	2	5.5	0.34	1.8	0.97	16	0.343
	72	20.75	19	16	1.5	1.5	1.5	1.5	61.5	63	5600	7500	30306	40	37	62	65	66	4	6	0.31	1.9	1.05	15	0.390
	72	28.75	27	23	1.5	1.5	1.5	1.5	77	84	5300	7000	32306	38	37	59	65	66	2	6	0.31	1.9	1.05	18	0.554
35	62	18	18	14	1	1	1	1	42	52	6000	8000	32007	40		54	56	59	4	4	0.45	1.3	0.73	15	0.384
	65	18	18	14	3.5	3.5	1.2	1.2	40.8	41	5000	7000	30607	42	47	55	65	62	2	4	0.38	1.6	0.88	14	0.229
	72	18.25	17	15	1.5	1.5	1.5	1.5	50.5	55	5300	7000	30207	44	42	62	65	67	3	3.3	0.37	1.6	0.88	15	0.318
	72	24.25	23	19	1.5	1.5	1.5	1.5	66	80	5300	7000	32207	42	42	61	65	68	2	5.3	0.37	1.6	0.88	17	0.452
	72	28	28	22	1.5	1.5	1.5	1.5	87.5	106	4800	6300	33207	42	42	59	65	69	2	6	0.35	1.7	0.93	18	0.519
	80	22.75	21	15	2	2	1.5	1.5	68	76	4500	6000	31307	45	44	62	71	76	3	7.5	0.83	0.7	0.4	25	0.515
	80	22.75	21	18	2	2	1.5	1.5	68.5	65	5000	6700	30307	47	44	68	73	75	3	5.5	0.31	1.9	1.05	16	0.515
	80	32.75	31	25	2	2	1.5	1.5	90.5	94	4800	6300	32307	43	44	66	71	74	4	8.5	0.31	1.9	1.05	20	0.755
40	68	19	19	14.5	1	1	1	1	58.5	79.5	5300	7000	32008	47	44	59	64	66	3	4.5	0.38	1.6	0.87	15	0.297
	75	26	26	20.5	1.5	1.5	1.5	1.5	81	104	5000	6700	33108	65	47	65	68	71	4	5.5	0.35	1.7	0.9	18	0.499
	80	19.75	18	16	1.5	1.5	1.5	1.5	66	73	4800	6300	30208	49	47	69	73	75	3	3.8	0.37	1.6	0.88	17	0.430
	80	24.75	23	19	1.5	1.5	1.5	1.5	79	93	4800	6300	32208	48	47	68	73	76	3	5.8	0.37	1.6	0.88	18	0.561
	80	32	32	25	1.5	1.5	1.5	1.5	113	126	4300	5600	33208	47	48	65	73	77	2	7	0.36	1.7	0.92	21	0.701
	90	25.25	23	17	2	2	1.5	1.5	81	77	4000	5300	31308	48	49	71	81	87	4	9.5	0.83	0.7	0.4	29	0.731
	90	25.25	33	20	2	2	1.5	1.5	95.5	102	4500	6000	30308	52	49	77	81	84	3	5.5	0.35	1.7	0.96	19	0.734

# Metric Single Row Tapered Roller Bearings

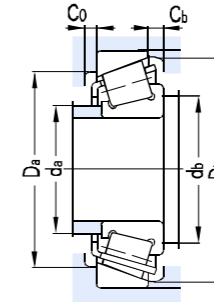
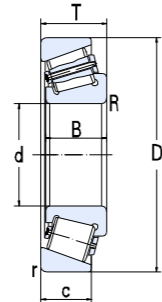
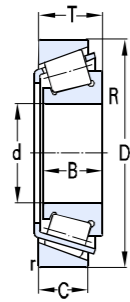

Basic dimensions									Basic load ratings		Limit speed		Designations	Abutment and fillet dimensions						Calculation factor				Weight	
d	D	T	B	C	R <sub>radial</sub>	R <sub>axial</sub>	r <sub>radial</sub>	r <sub>axial</sub>	Cr	Cor	Grease	Oil		d <sub>amax</sub>	d <sub>bmin</sub>	D <sub>amin</sub>	D <sub>amax</sub>	D <sub>bmin</sub>	C <sub>amin</sub>	C <sub>bmin</sub>	e	Y	Y <sub>0</sub>		a
mm									KN		r/min			mm										Kg	
	90	35.25	33	27	2	2	1.5	1.5	117	140	4000	5300	32308	49	49	73	81	83	4	8.5	0.35	1.7	0.96	22	1.080
42	100	38.25	36	30	2	2	1.5	1.5	153	174	3600	4800	323/42R 306/42	58	51	81	93	93	3	8.3	0.35	1.7	0.96	25	1.55
	76	24	27.5	19.8	2	2	2	2	76	101	4700	6250		52	49	65	71	73	3	6	0.28	2.2	1.19	29	0.479
45	75	20	20	15.5	1	1	1	1	57.5	80	4800	6300	32009	52	49	65	71	73	3	6	0.39	1.5	0.84	17	0.343
	80	26	26	20.5	1.5	1.5	1.5	1.5	91.7	118	4500	6000	33109	52	57	69	73	77	4.5	6.5	0.383				0.536
	85	20.75	19	16	1.5	1.5	1.5	1.5	70.5	83	4500	6000	30209	53	52	74	78	80	3	5	0.4	1.5	0.81	18	0.464
	85	24.75	23	19	1.5	1.5	1.5	1.5	86.9	105	4500	6000	32209	53	52	73	78	81	3	5.8	0.4	1.5	0.81	20	0.576
	85	32	32	25	1.5	1.5	1.5	1.5	115	150	4000	5300	33209	52	53	70	78	82	3	7	0.39	1.6	0.86	22	0.789
	100	27.25	25	18	2	2	1.5	1.5	101	97	3600	4800	31309	54	54	79	91	96	4	9.5	0.83	0.7	0.4	32	0.977
	100	27.25	25	22	2	2	1.5	1.5	103	107	4000	5300	30309	59	54	86	91	94	4	8.5	0.35	1.7	0.96	21	0.987
	100	38.25	36	30	2	2	1.5	1.5	153	174	3600	4800	32309	56	54	82	91	93	4	8.5	0.35	1.7	0.96	25	1.44
47	100	43	43	37	1.8	1.8	1.8	1.8	151	190	3400	4500	306/47	57	55	79	100	93	4	6	0.31	1.9	1.07	27	1.66
50	80	20	20	15.5	1	1	1	1	60	86.5	4500	6000	32010	57	54	70	76	78	4	4.5	0.42	1.4	0.78	18	0.381
	80	24	24	19	1	1	1	1	77	111	4500	6000	33010	55	58	70	77	76	4	4.5	0.32	1.9	1.04	17	0.442
	82	21.5	21.5	17	3	3	0.5	0.5	68.5	73	3200	4300	30610	57	62	72	82	79	3	4.5	0.31	2	1.08	16	0.331
	90	21.75	20	17	1.5	1.5	1.5	1.5	72.5	74	4300	5600	30210	58	57	79	83	86	3	5	0.42	1.4	0.79	20	0.550
	90	24.75	23	19	1.5	1.5	1.5	1.5	170	110	4300	5600	32210	58	57	78	83	85	3	5.5	0.43	1.4	0.8	21	0.640
	90	32	32	24.5	1.5	1.5	1.5	1.5	119	160	3800	5000	33210	57	58	75	83	88	3	7.5	0.41	1.5	0.8	23	1.17
	110	29.25	27	23	2.5	2.5	2.5	2.5	136	150	3600	4800	30310	65	60	95	100	103	4	6	0.35	1.7	0.96	23	1.26
	110	29.25	27	19	2.5	2.5	2	2	116	124	3200	4300	31310	63	10	86	102	104	3	10	0.83	0.7	0.4	35	1.25
110	42.25	40	33	2.5	2.5	2	2	173	214	3600	4800	32310	61	60	90	100	102	5	9.5	0.35	1.7	0.96	27	1.26	
50.8	100	35	35	27	1.5	1.5	1.5	1.5	141	193	3200	4300	339/50.8	64	58	83	93	97	4.5	8	0.4	1.5	0.83	25	1.267
	100	35	35	29	2	2	2	2	131	171	3200	4300	306/50.8	63	59	83	92	94	3	6	0.3	2	1.1	23	1.27
55	90	23	23	17.5	1.5	1.5	1.5	1.5	77	111	4000	5300	32011	64	63	79	83	88	4.5	5.5	0.41	1.5	0.81	20	0.564
	90	27	27	21	1.5	1.5	1.5	1.5	101	147	4000	5300	33011	62	65	78	83	87	4.5	5.5	0.31	1.92	1.06	19	0.839
	95	30	30	23	1.5	1.5	1.5	1.5	105	163	3800	5000	33111/HA	64	63	81	88	92	3	7	0.37	1.6	0.88	22	0.881
	100	22.75	21	18	2	2	1.5	1.5	99	110	3800	5000	30211	64	64	88	91	95	4	5	0.4	1.5	0.81	21	0.713
	100	26.75	25	21	2	2	1.5	1.5	108	133	3800	5000	32211	62	64	87	91	95	4	5.7	0.4	1.5	0.81	22	0.878
	100	35	35	27	2	2	1.5	1.5	143	196	3400	4500	33211	63	64	85	93	96	6	8	0.4	1.5	0.8	25	1.17
	120	31.5	29	25	2.5	2.5	2	2	156	178	3200	4300	30311	70	65	104	110	112	4	6.5	0.35	1.7	0.96	25	1.65
	120	31.5	29	21	2.5	2.5	2	2	155	166	2800	3800	31311	68	65	92	112	112	3	11	0.83	0.7	0.4	38	1.78

# Metric Single Row Tapered Roller Bearings

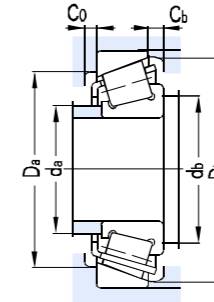
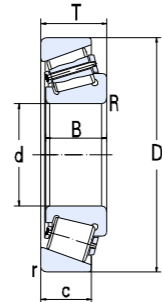
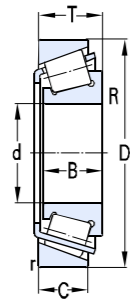

Basic dimensions									Basic load ratings		Limit speed		Designations	Abutment and fillet dimensions						Calculation factor				Weight	
d	D	T	B	C	R <sub>radial</sub>	R <sub>axial</sub>	r <sub>radial</sub>	r <sub>axial</sub>	Cr	Cor	Grease	Oil		d <sub>amax</sub>	d <sub>bmin</sub>	D <sub>amin</sub>	D <sub>amax</sub>	D <sub>bmin</sub>	C <sub>amin</sub>	C <sub>bmin</sub>	e	Y	Y <sub>0</sub>		a
mm									KN		r/min			mm										Kg	
	120	45.5	43	35	2.5	2.5	2	2	218	280	3000	4000	32311 30611B	66	65	99	110	111	5	11	0.35	1.7	0.96	29	2.43
	125	37	36	25	3	3	2	2	148	172	2800	3800		69	67	95	117	117	3	12	0.73	0.8	0.45	38	2.10
60	85	17	17	14	1	1	1	1	40	65	3900	5100	32912	65	68	76	81	79	4	3	0.38	1.6	0.87	17	0.284
	95	23	23	17.5	1.5	1.5	1.5	1.5	90.3	112	3800	5000	32012	68	68	83	88	92	5	5.5	0.4	1.4	0.77	21	0.597
	95	27	27	21	1.5	1.5	1.5	1.5	101	158	2800	5000	33012	67	67	85	88	90	5	6	0.33	1.8	1	20	0.691
	100	30	30	23	1.5	1.5	1.5	1.5	116	171	3600	4800	33112	68	68	85	93	97	3.5	7	0.4	1.5	0.83	23	0.895
	110	23.75	22	19	2	2	1.5	1.5	106	124	3400	4500	30212	69	69	96	101	103	4	5	0.4	1.5	0.81	23	0.923
	110	29.75	28	24	2	2	1.5	1.5	133	170	3400	4500	32212	69	68	95	101	104	4	5.8	0.4	1.5	0.81	25	1.26
	130	33.5	31	26	3	3	2.5	2.5	163	185	3000	4000	30312	76	72	112	118	121	3.5	7.5	0.35	1.7	0.96	26	1.96
	130	33.5	31	22	3	3	2.5	2.5	138	155	2600	3600	31312	69	72	103	118	124	5	12	0.83	0.7	0.4	41	1.92
	130	48.5	46	37	3	3	2.5	2.5	229	289	2600	3600	32312	72	72	107	118	122	6	12	0.35	1.7	0.96	31	2.90
65	100	23	23	17.5	1.5	1.5	1.5	1.5	91.7	128	3400	4500	32013	72	72	90	93	97	4	5.5	0.46	1.3	0.7	22	0.612
	100	27	27	21	1.5	1.5	1.5	1.5	108	158	3400	4500	33013	72	73	87	93	97	3.5	6	0.3	1.7	0.95	21	0.732
	110	30.35	30	24	3	4	1.8	1.8	109	155	3200	4300	7813	76	79	94	105	106	3.5	6.4	0.4	1.5	0.82	25	1.10
	110	34	34	26.5	1.5	1.5	1.5	1.5	157	220	3200	4300	33113	76	73	94	103	107	3.5	7.5	0.39	1.6	0.85	26	1.30
	120	24.75	23	20	2	2	1.5	1.5	125	147	3000	4000	30213	77	74	106	111	114	4	5	0.4	1.5	0.81	24	1.14
	120	32.75	31	27	2	2	1.5	1.5	151	192	3000	4000	32213	75	74	104	111	115	4	5.8	0.4	1.5	0.81	28	1.58
	120	41	41	32	2	2	1.5	1.5	222	282	2800	3800	33213	75	74	102	113	115	6	9	0.4	1.5	0.8	29	2.00
	130	45	43	35	7	7	2	2	223	298	2800	3800	30613	80	66	108	122	122	3.5	10	0.33	1.8	0.99	30	2.64
	140	36	33	23	3	3	2.5	2.5	184	198	2800	3800	31313	75	77	111	128	134	5	13	0.83	0.7	0.4	44	2.46
	140	36	33	28	3	3	2.5	2.5	188	216	2600	3600	30313	83	72	120	131	131	3.5	8	0.35	1.7	0.96	28	2.49
140	51	48	39	3	3	2.5	2.5	264	335	2400	3400	32313	79	77	117	128	131	6	12	0.35	1.7	0.96	33	3.68	
70	100	20	20	16	1	1	1	1	70.5	114	3000	4000	32914	76	76	90	96	96	5	4	0.32	1.9	1.05	18	0.475
	110	25	25	19	1.5	1.5	1.5	1.5	106	163	3000	4000	32014	93	78	112	103	125	5	6	0.43	1.4	0.76	26	0.972
	120	37	37	29	2	2	1.5	1.5	164	258	3000	4000	33114	82	79	102	113	116	3.5	8	0.38	1.6	0.87	28	1.72
	120	45	42	37	2.5	2.5	2.5	2.5	138	198	3000	4000	30614	79	80	99	111	115	3.5	8	0.39	1.5	0.84	32	1.89
	125	26.25	24	21	2	2	1.5	1.5	119	142	3000	4000	30214	81	69	110	116	118	4	5.3	0.42	1.4	0.79	26	1.29
	125	33.25	31	27	2	2	1.5	1.5	170	227	2800	3800	32214	79	79	106	118	120	4	6.3	0.42	1.4	0.79	29	1.66
	125	41	41	32	2	2	1.5	1.5	191	285	2800	3800	33214	78	89	106	134	120			0.41				
	150	38	35	25	3	3	2.5	2.5	192	226	2400	3400	31314	78	82	118	138	140	5	13	0.83	0.7	0.4	47	2.87
	150	38	35	30	3	3	2.5	2.5	223	262	2400	3400	30314	89	82	130	138	141	5	8	0.35	1.7	0.96	30	3.08
	150	54	51	42	3	3	2.5	2.5	305	390	2200	3200	32314	84	82	125	138	141	6	12	0.35	1.7	0.96	36	4.38
75	115	25	25	19	1.5	1.5	1.5	1.5	104	160	3000	4000	32015	84	83	100	108	112	6	6	0.46	1.3	0.72	25	0.922

# Metric Single Row Tapered Roller Bearings

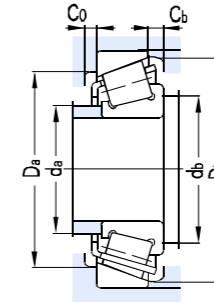
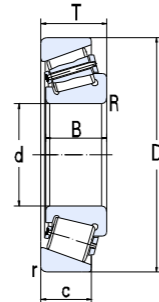
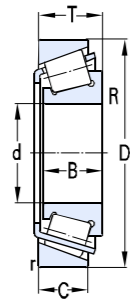

Basic dimensions									Basic load ratings		Limit speed		Designations	Abutment and fillet dimensions						Calculation factor				Weight	
d	D	T	B	C	R <sub>radial</sub>	R <sub>axial</sub>	r <sub>radial</sub>	r <sub>axial</sub>	Cr	Cor	Grease	Oil		d <sub>amax</sub>	d <sub>bmin</sub>	D <sub>amin</sub>	D <sub>amax</sub>	D <sub>bmin</sub>	C <sub>amin</sub>	C <sub>bmin</sub>	e	Y	Y <sub>0</sub>		a
mm									KN		r/min			mm										Kg	
	115	31	31	25.5	1.5	1.5	1.5	1.5	130	213	3000	4000	33015	84	82	104	108	110	6	5.5	0.3	2	1.1	23	1.10
	125	37	37	29	2	2	1.5	1.5	174	275	2800	3800	33115	87	84	107	118	121	4.5	8	0.4	1.5	0.83	29	1.80
	130	27.25	25	22	2	2	1.5	1.5	139	175	2800	3800	30215	85	84	115	121	125	4.5	5.3	0.44	1.4	0.76	28	1.40
	130	33.25	31	27	2	2	1.5	1.5	173	231	2600	3600	32215	84	84	115	126	126	4.5	6.3	0.44	1.4	0.76	30	1.76
	130	41	41	31	2	2	1.5	1.5	199	282	2600	3600	33215	87	84	109	123	126	4.5	10	0.43	1.4	0.77	32	2.27
	135	44.5	45	36.5	2.5	2.5	2.5	2.5	232	340	2600	3600	30615	90	76	115	126	128	6	8	0.28	2.2	1.19	29	2.79
	160	40	37	31	3	3	2.5	2.5	259	285	2200	3200	30315	95	87	139	148	150	4.5	9	0.35	1.7	0.96	32	3.71
	160	40	37	26	3	3	2.5	2.5	229	276	2200	3200	31315	86	87	127	148	153	6	14	0.83	0.7	0.4	50	3.40
	160	58	55	45	3	3	2.5	2.5	345	455	2000	3000	32315	94	87	131	151	150	4.5	13	0.35	1.7	0.96	38	5.35
76	141	28.25	26	22	0.5	0.5	2	2	165	209	2300	3400	306/76	91	80	123	125	134	6.5	8	0.42				1.83
80	110	20	20	16	1	1	1	1	71	119	2700	3700	32916	86	88	100	106	106	5	6	0.35	1.7	0.96	38	0.548
	125	29	29	22	1.5	1.5	1.5	1.5	139	219	2600	3600	32016	90	88	109	118	121	6	7	0.42	1.4	0.78	27	1.26
	125	36	36	29.5	1.5	1.5	1.5	1.5	172	281	2600	3600	33016	90	87	112	117	119	6	6.5	0.28	2.1	1.1	26	1.62
	130	37	37	29	2	2	1.5	1.5	179	280	2600	3600	33116	91	81	111	123	127	4.5	8	0.42	1.4	0.79	31	2.79
	140	28.25	26	22	2.5	2.5	2	2	146	178	2400	3400	30216	90	90	124	130	133	4.5	6.3	0.42	1.4	0.79	29	1.56
	140	35.25	33	28	2.5	2.5	2	2	198	263	2400	3400	32216	89	90	122	130	135	5	7.3	0.42	1.4	0.79	32	2.19
	140	46	46	35	2.5	2.5	2	2	264	390	2200	3200	33216	90	90	117	132	136	4.5	11	0.43	1.4	0.78	35	2.89
	170	42.5	39	27	3	3	2.5	2.5	223	260	2200	3200	31316	92	91	128	156	156	6	16	0.83	0.7	0.4	53	3.65
	170	42.5	39	33	3	3	2.5	2.5	273	320	2000	3000	30316	102	92	146	158	160	5	9.5	0.35	1.7	0.96	34	4.32
	170	61.5	58	48	3	3	2.5	2.5	390	510	1900	2800	32316	97	92	142	158	160	4.5	14	0.35	1.7	0.96	41	6.43
85	130	29	29	22	1.5	1.5	1.5	1.5	138	220	2400	3400	32017	94	93	114	123	126	7	7	0.44	1.4	0.75	28	1.33
	130	36	36	29.5	1.5	1.5	1.5	1.5	195	330	2600	3600	33017	94	92	118	122	125	6	6.5	0.3	2	1.1	26	1.70
	140	41	41	32	2.5	2.5	2	2	215	350	2400	3400	33117	98	95	119	132	136	4.5	9	0.41	1.5	0.81	33	2.43
	150	30.5	28	24	2.5	2.5	2	2	167	204	2400	3400	30217	96	95	132	140	142	5	6.5	0.42	1.4	0.79	31	2.05
	150	38.5	36	30	2.5	2.5	2	2	230	315	2200	3200	32217	95	95	130	140	143	5	8.5	0.42	1.4	0.79	34	2.70
	150	49	49	37	2.5	2.5	2	2	286	236	2000	3000	33217	96	95	125	142	145	4.5	12	0.42	1.4	0.79	37	3.64
	180	44.5	41	28	4	4	3	3	254	300	2000	3000	31317	96	99	143	166	171	6	17	0.83	0.7	0.4	56	4.92
	180	44.5	41	34	4	4	3	3	299	355	1900	2800	30317	107	99	156	166	168	6	11	0.35	1.7	0.96	35	5.39
	180	63.5	60	49	4	4	3	3	425	560	1800	2600	32317	102	99	150	166	168	4.5	15	0.35	1.7	0.96	42	7.37
90	140	32	32	24	2	2	1.5	1.5	165	255	2200	3200	32018	100	99	122	133	135	7	8	0.42	1.4	0.78	30	1.77
	140	39	39	32.5	2	2	1.5	1.5	226	370	2200	3200	33018	100	99	127	132	135	7	6.5	0.27	2.2	1.3	27	2.24
	150	45	45	35	2.5	2.5	2	2	242	390	2000	3000	33118	101	101	130	140	144	7	10	0.4	1.5	0.8	35	3.15
	160	32.5	30	26	2.5	2.5	2	2	222	291	2000	3000	30218	102	100	140	150	151	5	6.5	0.42	1.4	0.79	33	2.73

# Metric Single Row Tapered Roller Bearings

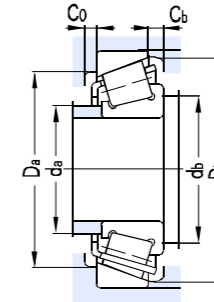
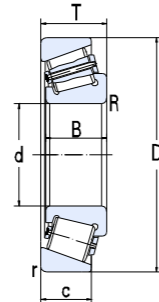
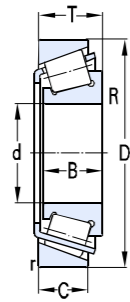

Basic dimensions									Basic load ratings		Limit speed		Designations	Abutment and fillet dimensions						Calculation factor				Weight	
d	D	T	B	C	R <sub>radial</sub>	R <sub>axial</sub>	r <sub>radial</sub>	r <sub>axial</sub>	Cr	Cor	Grease	Oil		d <sub>amax</sub>	d <sub>bmin</sub>	D <sub>amin</sub>	D <sub>amax</sub>	D <sub>bmin</sub>	C <sub>amin</sub>	C <sub>bmin</sub>	e	Y	Y <sub>0</sub>		a
mm									KN		r/min			mm										Kg	
	160	42.5	40	34	2.5	2.5	2	2	274	280	2000	3000	32218	101	100	138	150	152	5	8.5	0.42	1.4	0.79	37	3.61
	160	55	55	42	2.5	2.5	2	2	330	495	2000	3000	33218	95	99	115	160	126	7	13	0.29	2.1	1.13	33	4.77
	170	62	59.5	49	2.5	2.5	2.5	2.5	360	520	2000	3000	30618	107	100	139	161	161	4.5	13	0.36	1.7	0.92	42	6.04
	190	46.5	43	30	4	4	3	3	283	340	2000	3000	31318	102	104	151	176	181	6	17	0.83	0.7	0.4	59	5.53
	190	46.5	43	36	4	4	3	3	335	410	1800	2600	30318	113	104	165	176	178	6	11	0.35	1.7	0.96	37	5.76
	190	67.5	64	53	4	4	3	3	485	650	1700	2400	32318	107	104	157	176	178	8	15	0.35	1.7	0.96	45	8.97
95	145	32	32	24	2	2	1.5	1.5	182	292	2200	3200	32019	105	104	130	138	139	6	8	0.44	1.35	0.8	31	1.87
	145	39	39	32.5	2	2	1.5	1.5	210	345	2200	3200	33019	105	104	128	138	140	4.5	6.5	0.28	2.2	1.19	29	2.32
	160	47	47	38	3	3	3	3	286	460	2200	3200	30619	108	107	137	149	153	4.5	9	0.34	1.8	0.97	35	3.79
	160	47	47	38	3	3	2.5	2.5	325	435	2200	3200	7819E	67	107	96	151	110	4.5	9	0.28	2.2	1.19	28	3.73
	170	34.5	32	27	3	3	2.5	2.5	233	300	1900	2800	30219	108	107	149	158	160	5	7.5	0.42	1.4	0.79	35	3.27
	170	45.5	43	37	3	3	2.5	2.5	298	415	1900	2800	32219	106	107	145	158	163	5	8.5	0.42	1.4	0.79	40	4.34
	170	58	58	44	3	3	2.5	2.5	405	560	1900	2800	33219	109	107	141	161	164	7	14	0.41	1.5	0.81	43	5.54
	200	49.5	45	32	4	4	3	3	305	370	1900	2800	31319	107	109	157	186	189	6	18	0.83	0.7	0.4	62	6.84
	200	49.5	45	38	4	4	3	3	365	445	1800	2600	30319	118	109	172	186	185	6	12	0.35	1.7	0.96	39	6.91
	200	71.5	67	55	4	4	3	3	520	705	1700	2400	32319	114	109	166	186	187	8	17	0.35	1.7	0.96	47	10.0
100	150	32	32	24	2	2	1.5	1.5	190	281	1600	2200	32020	110	109	131	143	145	4.5	8	0.46	1.3	0.72	33	1.87
	150	39	39	32.5	2	2	1.5	1.5	253	390	2000	3000	33020	109	109	132	143	144	4.5	6.5	0.29	2.1	1.15	29	2.36
	180	37	34	29	3	3	2.5	2.5	262	340	1900	2800	30220	114	112	157	168	169	5	8	0.42	1.4	0.79	37	3.56
	180	49	46	39	3	3	2.5	2.5	345	490	1800	2600	32220	113	112	154	168	172	5	10	0.42	1.4	0.79	42	5.31
	180	63	63	48	3	3	2.5	2.5	430	655	1700	2400	33220	112	112	151	168	172	10	15	0.4	1.5	0.8	43	6.58
	215	51.5	47	39	4	4	3	3	405	495	1700	2400	30320	127	114	184	201	199	6	13	0.35	1.7	0.96	41	8.09
	215	77.5	73	60	4	4	3	3	610	840	1600	2200	32320	122	114	177	201	201	8	18	0.35	1.7	0.96	51	13.2
	215	56.5	51	35	4	4	3	3	390	490	1600	2200	31320	121	115	168	201	202	7	21.5	0.83	0.72	0.4	65	8.78
105	170	56	56	44	3	3	2.5	2.5	375	605	1700	2200	30621	125	122	148	162	164	4.5	9	0.43	1.4	0.77	35	4.71
	160	35	35	26	2.5	2.5	2	2	199	320	1900	2800	32021	116	116	143	150	154	6	9	0.44	1.35	0.8	34	2.38
	160	43	43	34	2.5	2.5	2	2	266	405	1900	2800	33021	117	115	141	152	154	4.5	9	0.28	2.1	1.17	31	2.98
	190	39	36	30	3	3	2.5	2.5	292	365	1800	2600	30221	125	117	162	181	177	6	9	0.42	1.4	0.79	39	4.47
	190	53	50	43	3	3	2.5	2.5	385	555	1800	2600	32221	118	117	161	178	182	5	10	0.42	1.4	0.79	45	6.34
	190	68	68	52	3	3	2.5	2.5	475	730	1800	2600	33221	129	117	165	194	188	4.5	18	0.35	1.9	1.05	49	8.02
	190	53	50	43	3	3	2.5	2.5	375	605	1800	2600	32221	120	117	161	178	180	6	10	0.43	1.4	0.8	44	6.26
	225	53.5	49	41	4	4	3	3	430	530	1600	2200	30321	133	119	193	211	208	7	13	0.35	1.7	0.96	43	9.38
	225	81.5	77	63	4	4	3	3	660	915	1500	2000	32321	128	119	185	211	210	8	19	0.35	1.7	0.96	54	15.0

# Metric Single Row Tapered Roller Bearings

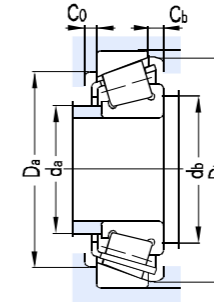
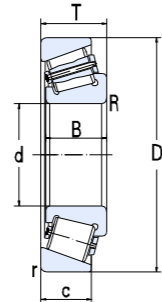
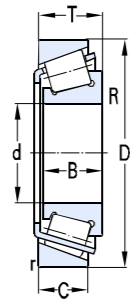

Basic dimensions									Basic load ratings		Limit speed		Designations	Abutment and fillet dimensions						Calculation factor				Weight	
d	D	T	B	C	R <sub>radial</sub>	R <sub>axial</sub>	r <sub>radial</sub>	r <sub>axial</sub>	Cr	Cor	Grease	Oil		d <sub>amax</sub>	d <sub>bmin</sub>	D <sub>amin</sub>	D <sub>amax</sub>	D <sub>bmin</sub>	C <sub>amin</sub>	C <sub>bmin</sub>	e	Y	Y <sub>0</sub>		a
mm									KN		r/min			mm										Kg	
110	170	38	38	29	2.5	2.5	2	2	231	365	1800	2600	32022	123	120	148	162	164	4.5	9	0.43	1.4	0.77	37	3.08
	170	47	47	37	2.5	2.5	2	2	300	465	1800	2600	33022	123	120	148	162	162	4.5	10	0.29	2.1	1.15	33	3.75
	180	56	56	43	2.5	2.5	2	2	350	595	1800	2600	33122	125	120	151	172	175	4.5	13	0.42	1.4	0.79	44	5.56
	200	41	38	32	3	3	2.5	2.5	320	430	1700	2400	30222	132	122	171	191	187	6	9	0.42	1.4	0.79	41	5.27
	200	56	53	46	3	3	2.5	2.5	465	695	1700	2400	32222	124	122	170	188	192	6	10	0.42	1.4	0.79	48	7.62
	240	54.5	50	42	4	4	3	3	470	580	1600	2200	30322	142	124	206	226	222	8	13	0.35	1.7	0.96	45	11.1
	240	63	57	38	4	4	3	3	470	595	1600	2200	31322	129	124	188	226	226	7	25	0.83	0.7	0.4	75	12.5
	240	84.5	80	65	4	4	3	3	735	1030	1400	1900	32322	137	124	198	226	224	9	20	0.35	1.7	0.96	56	18.0
115	190	49	49	35	2.5	2.5	2.5	2.5	282	440	1600	2200	30623	131	120	160	181	180	4.5	14	0.44	1.4	0.74	42	5.13
120	165	29	29	23	1.5	1.5	1.5	2.5	189	320	1600	2200	32924	131	118	150	158	161	4.5	6	0.35	1.7	0.95	29	1.79
	180	38	38	29	2.5	2.5	2	2	237	395	1700	2400	32024	132	120	157	172	175	4.5	9	0.46	1.3	0.72	40	3.31
	180	48	48	38	2.5	2.5	2	2	295	530	1800	2600	33024	132	131	160	170	171	6	10	0.3	2	1.1	36	4.07
	200	62	62	48	2.5	2.5	2	2	440	770	1700	2400	33124	135	132	177	190	190	6	9.5	0.44	1.4	0.76	45	7.74
	215	43.5	40	34	3	3	2.5	2.5	330	445	1600	2200	30224	139	132	187	203	203	6	9.5	0.44	1.4	0.76	45	6.32
	215	61.5	58	50	3	3	2.5	2.5	480	720	1600	2200	32224	134	132	181	203	206	7	12	0.44	1.4	0.76	52	9.60
	260	59.5	55	46	4	4	3	3	565	710	1500	2000	30324	153	134	221	246	238	8	14	0.35	1.7	0.96	49	14.2
	260	68	62	42	4	4	3	3	540	690	1500	2000	31324	140	134	203	246	246	9	26	0.83	0.7	0.4	82	15.6
260	90.5	86	69	4	4	3	3	860	1330	1300	1800	32324	148	135	213	245	239	9	21.5	0.35	1.7	0.9	60	22.4	
130	200	45	45	34	2.5	2.5	2	2	340	580	1600	2200	32026	144	142	178	190	192	7	11	0.43	1.4	0.8	42	5.06
	230	43.75	40	34	4	4	3	3	360	480	1500	2000	30226	150	144	203	216	219	7	10	0.44	1.4	0.76	47	7.02
	230	67.75	64	54	4	4	3	4	555	845	1500	2000	32226	143	144	193	216	221	7	14	0.44	1.4	0.76	56	11.8
	280	63.75	58	49	5	5	4	5	645	815	1300	1800	30326	165	145	239	262	258	8	15	0.35	1.7	0.96	53	17.4
	280	72	66	44	5	5	4	4	620	805	1300	1800	31326	150	147	218	262	263	9	28	0.83	0.7	0.4	87	18.9
140	190	32	32	25	2	2	1.5	1.5	206	390	1600	2200	32928	150	150	177	182	184	6	7	0.35	1.7	0.9	33	2.55
	210	45	45	34	2.5	2.5	2	2	330	560	1600	2200	32028	154	150	183	202	204	4.5	11	0.46	1.3	0.72	46	5.84
	230	58	57	45	3	3	3	3	400	660	1600	2200	30628	182	152	217	219	242	4.5	13	0.44	1.4	0.74	56	8.97
	250	45.75	42	36	4	4	3	3	405	540	1400	1900	30228	162	154	219	236	234	9	11	0.44	1.4	0.76	50	8.80
	250	71.75	68	58	4	4	3	3	650	1000	1400	1900	32228	156	154	210	236	240	8	14	0.44	1.4	0.76	61	14.7
	300	67.75	62	53	5	5	4	4	740	945	1200	1700	30328	176	155	255	282	275	9	15	0.35	1.7	0.96	56	21.2
	300	107.75	102	85	5	5	4	4	1090	1630	1200	1700	32328	177	156	239	287	276	9	22.8	0.37	1.6	0.9	74	35.8
	300	77	70	47	5	5	4	4	695	900	1200	1700	31328	162	157	235	282	283	9	30	0.83	0.7	0.4	93	23.4
150	210	38	38	30	2.5	2.5	2	2	270	465	1500	2000	32930	161	160	190	202	202	9	7.5	0.33	1.83	1	36	3.83

# Metric Single Row Tapered Roller Bearings

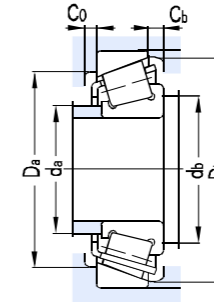
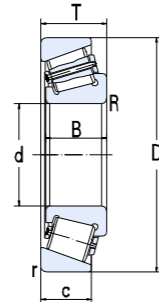
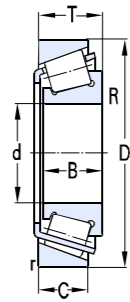

Basic dimensions									Basic load ratings		Limit speed		Designations	Abutment and fillet dimensions						Calculation factor				Weight	
d	D	T	B	C	R <sub>radial</sub>	R <sub>axial</sub>	r <sub>radial</sub>	r <sub>axial</sub>	Cr	Cor	Grease	Oil		d <sub>amax</sub>	d <sub>bmin</sub>	D <sub>amin</sub>	D <sub>amax</sub>	D <sub>bmin</sub>	C <sub>amin</sub>	C <sub>bmin</sub>	e	Y	Y <sub>0</sub>		a
mm									KN		r/min			mm										Kg	
	225	48	48	36	3	3	2.5	2.5	365	635	950	1400	32030	161	160	197	216	217	9	13	0.46	1.3	0.72	49	6.40
	270	49	45	38	4	4	3	3	450	605	1300	1800	30230	174	164	234	256	252	9	11	0.44	1.4	0.76	53	11.2
	270	77	73	60	4	4	3	3	735	1140	1200	1700	32230	168	164	223	256	256	4.5	17	0.44	1.4	0.76	64	18.4
	320	72	65	55	5	5	4	4	815	1050	1100	1600	30330	190	165	273	302	294	4.5	17	0.35	1.7	0.96	60	25.5
	320	82	75	50	5	5	4	4	810	1060	950	1400	31330	181	170	251	303	300	9	32	0.83	0.72	0.4	96	27.5
	320	114	108	90	5	5	4	4	1280	1880	950	1400	32330	190	166	261	307	299	4.5	24	0.35	1.7	0.96	77	42.2
160	240	51	51	38	3	3	2.5	2.5	415	730	1100	1600	32032	174	173	211	231	232	8	13	0.46	1.3	0.72	53	7.69
	290	52	48	40	4	4	3	3	510	695	1100	1600	30232	189	174	252	276	271	9	12	0.44	1.4	0.76	57	13.4
	290	84	80	67	4	4	3	3	925	1490	1100	1600	32232	180	174	242	276	276	10	17	0.44	1.4	0.76	70	23.3
	340	75	68	58	5	5	4	4	915	1180	1000	1500	30332	201	180	290	323	310	9	17	0.35	1.7	0.9	61	29.5
	340	88	79	54	3.7	3.7	3.7	3.7	825	1080	1000	1500	31332	199	161	265	340	315	4.5	34	0.76	0.8	0.43	100	29.9
	340	121	114	95	5	5	4	4	1540	2230	1000	1500	32332	199	176	274	327	314	4.5	26	0.35	1.7	0.96	81	51.7
	375	86.55	79.4	50.3	5	5	5	5	870	1050	1000	1500	30632	214	176	295	375	337	4.5	37	0.7	0.9	0.47	98	40.7
170	230	38	38	30	2.5	2.5	2	2	280	560	1400	1900	32934	183	182	213	220	222	7	8	0.37	1.6	0.9	42	4.51
	260	57	57	43	3	3	2.5	2.5	520	870	1200	1700	32034	188	184	230	246	249	10	14	0.44	1.35	0.8	56	10.6
	310	57	52	43	5	5	4	4	605	845	1000	1500	30234	203	190	268	293	288	8	14	0.43	1.4	0.8	58	17.0
	310	91	86	71	5	5	4	4	1010	1630	1000	1500	32234	196	190	259	293	294	10	20	0.43	1.4	0.8	75	30.0
	360	80	72	62	5	5	4	4	950	1360	980	1450	30334	216	187	305	307	331	10	20	0.34			75	35.8
180	250	45	45	34	2.5	2.5	2	2	345	725	1600	2500	32936	194	192	225	240	241	8	11	0.48	1.25	0.7	53	6.7
	280	64	64	48	3	3	2.5	2.5	611	1070	950	1400	32036	199	192	247	268	267	9	16	0.42	1.4	0.8	75	13.9
	320	57	52	43	5	5	4	4	590	820	1000	1500	30236	209	198	278	302	300	4.5	14	0.45	1.3	0.73	64	17.8
	320	91	86	71	5	5	4	4	1020	1670	950	1400	32236	208	196	264	307	304	10	20	0.45	1.3	0.73	78	32.3
	380	98	88	60	5	5	4	4	1050	1500	900	1300	31336	217	220	289	368	355	12	21	0.55	0.73	0.8	120	46.4
	380	83	75	64	5	5	4	4	1180	1580	900	1300	30336	207	233	362	324	345	10	19	0.36	1.7	0.92	72.4	41.4
190	260	45	45	34	2.5	2.5	2	2	340	745	1100	1600	32938	205	202	235	252	251	10	9.5	0.48	1.25	0.7	55	6.94
	290	64	64	48	3	3	2.5	2.5	650	1180	1000	1500	32038	210	204	257	276	279	10	16	0.44	1.35	0.8	62	14.5
	340	60	55	46	5	5	4	4	740	1040	950	1400	30238	229	206	294	327	317	4.5	14	0.44	1.4	0.76	67	20.6
	340	97	92	75	5	5	4	4	1100	1080	950	1300	32238	214	208	286	322	326	10	22	0.44	1.4	0.76	81	36.1
200	280	51	51	39	3	3	2.5	2.5	455	935	1000	1500	32940	218	215	252	271	270	4.5	11	0.39	1.5	0.84	54	9.56
	310	70	70	53	3	3	2.5	2.5	760	1370	950	1400	32040	222	214	273	296	297	11	17	0.43	1.4	0.8	66	19.5
	360	64	58	48	5	5	4	4	780	1100	900	1300	30240	236	218	315	342	338	9	16	0.44	1.4	0.76	70	25.4
	360	104	98	82	5	5	4	4	1350	2144	900	1300	32240	222	218	302	342	342	11	22	0.41	1.5	0.81	84	42.6



# Metric Single Row Tapered Roller Bearings

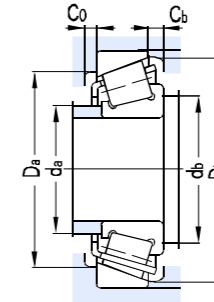
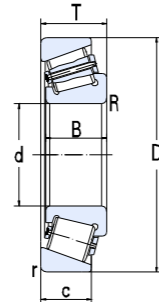
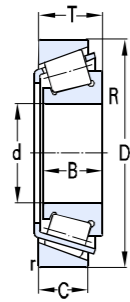

Basic dimensions									Basic load ratings		Limit speed		Designations	Abutment and fillet dimensions						Calculation factor				Weight	
d	D	T	B	C	R <sub>radial</sub>	R <sub>axial</sub>	r <sub>radial</sub>	r <sub>axial</sub>	Cr	Cor	Grease	Oil		d <sub>amax</sub>	d <sub>bmin</sub>	D <sub>amin</sub>	D <sub>amax</sub>	D <sub>bmin</sub>	C <sub>amin</sub>	C <sub>bmin</sub>	e	Y	Y <sub>0</sub>		a
mm									KN		r/min			mm										Kg	
	420	146	138	115	5	5	5	5	1820	2850	800	1100	32340	239	253	398	346	346	11	31	0.37	1.6	0.88	107	90.5
220	300	51	51	39	3	3	2.5	2.5	465	960	950	1400	32944	234	234	275	286	290	9	12	0.43	1.4	0.8	58	10.0
	340	76	76	57	4	4	3	3	850	1520	900	1300	32044	244	234	300	325	326	12	19	0.43	1.4	0.8	72	23.9
	400	72	65	54	5	5	4	4	975	1370	900	1300	30244	256	220	334	382	382	10	18	0.42	1.4	0.79	77	36.8
	400	114	108	90	5	5	4	4	1650	2770	900	1300	32244	256	220	334	382	382	10	24	0.44	1.4	0.76	96	62.7
240	320	51	51	39	3	3	2.5	2.5	500	1050	850	1200	32948	255	254	294	308	311	9	12	0.46	1.3	0.7	64	11.5
	360	76	76	57	4	4	3	3	1820	3300	850	1200	32048	262	256	318	345	346	12	19	0.46	1.3	0.7	78	26
	440	127	120	100	5	5	4	4	1900	3300	700	950	32248	276	262	365	420	415	14	27	0.43	1.4	0.8	105	82.5
	440	79	72	60	5	5	4	4	1070	1550	750	1000	30248	267	288	422	384	408	11	19	0.44	1.4	0.74	85	46.8
	500	165	155	132	6	6	5	5	2360	4100	670	900	32348	279	301	478	410	464	12	33	0.37	1.6	0.88	123	147
254	422.27	86.1	79.8	66.7	4.7	4.7	2.5	2.5	1110	1760	850	1200	306/254	297	270	370	413	399	13	19	0.36	1.7	0.9	80	45.4
255	560	123.05	104.8	70	6	6	6	6	1920	2690	560	750	30651	329	274	435	542	510	13	53.1	0.87	0.7	0.38	171	127
260	360	63.5	63.5	48	3	3	2.5	2.5	650	1270	800	1100	32952	286	272	325	351	344	13	13	0.3	2	1.09	60	17.9
	400	87	87	65	5	5	4	4	1110	2030	800	1100	32052	287	282	352	383	383	13	12	0.43	1.4	0.8	84	39.8
	480	89	80	67	6	6	5	5	1430	2150	670	900	30252	293	316	458	421	447	12	22	0.44	1.4	0.74	94	63.9
	480	137	130	105	6	6	5	5	2160	3650	670	900	32252	305	279	394	465	451	13	32	0.43	1.4	0.77	113	105
	540	114	102	85	6	6	6	6	2015	2730	670	900	30352	332	279	449	522	481	10	29	0.32	1.9	1.04	92	113
280	380	63.5	63.5	48	3	3	2.5	2.5	727	1500	800	1100	32956	305	292	344	371	364	13	13	0.43	1.4	0.77	100	20
	420	87	87	65	5	5	4	4	1200	2300	750	1000	32056	305	302	370	400	402	14	22	0.46	1.3	0.7	89	40.4
300	420	74.5	72	62	4	4	3	3	710	1810	700	950	32960	330	314	379	409	400	13	15	0.28	2.1	1.17	67	30.2
	420	76	76	57	4	4	3	3	997	1870	700	950	32976	324	317	383	404	405	12	19	0.4	1.5	0.8	79	50.0
	460	100	100	74	5	5	4	4	1460	2740	670	900	32060	330	322	404	440	439	15	26	0.43	1.4	0.8	97	56.6
	540	149	140	115	6	6	5	5	2680	4700	600	800	30660	343	326	453	518	511	17	34	0.43	1.4	0.8	126	142
320	440	76	76	57	4	4	3	3	1030	2300	650	900	32964	343	337	402	424	426	13	19	0.43	1.4	0.8	84	34.5
	480	100	100	74	5	5	4	4	1540	2940	630	850	32064	354	336	419	467	463	13	26	0.46	1.3	0.72	104	62.7
	580	104	92	75	6	6	5	5	1700	2560	530	750	30264	353	381	558	503	533	14	29	0.44	1.4	0.74	114	103
	620	141	125	107	7.5	7.5	7.5	7.5	2780	4600	520	680	30664	380	354	501	586	577	16	34	0.6	1	0.6	154	183
340	460	76	76	57	4	4	3	3	1030	2350	500	830	32968	361	357	421	444	446	14	19	0.44	1.35	0.8	90	36.5

# Metric Single Row Tapered Roller Bearings

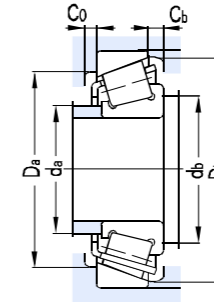
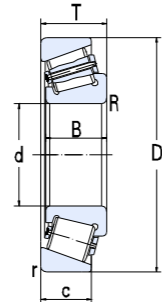
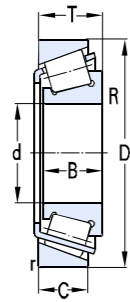

Basic dimensions									Basic load ratings		Limit speed		Designations	Abutment and fillet dimensions						Calculation factor				Weight	
d	D	T	B	C	R <sub>radial</sub>	R <sub>axial</sub>	r <sub>radial</sub>	r <sub>axial</sub>	Cr	Cor	Grease	Oil		d <sub>amax</sub>	d <sub>bmin</sub>	D <sub>amin</sub>	D <sub>amax</sub>	D <sub>bmin</sub>	C <sub>amin</sub>	C <sub>bmin</sub>	e	Y	Y <sub>0</sub>		a
mm									KN		r/min			mm										Kg	
360	480	76	76	57	4	4	4	4	1060	2220	500	630	32972 30672	388	374	433	467	468	13	19	0.46	1.3	0.72	97	38.5
	530	80	66	59	5	5	5	5	1030	1900	500	630		410	376	476	515	502	13	21	0.4	1.5	0.82	95	53.2
380	520	87	82	71	5	5	4	4	1190	2670	560	750	32976	407	406	502	478	501	16	16	0.39	1.6	0.86	95	50.0
400	500	60	57	47	4	4	3	3	460	950	400	500	30680	368	414	406	489	430	13	13	0.38	1.6	0.86	77	25.1
	540	87	82	71	5	5	4	4	1280	2880	380	480	32980	450	436	500	550	530	8	8	0.4	1.4	0.8	185	54.1
	540	70	65	48	4	4	4	4	965	1930	350	450	31980	450	436	500	550	530	8	8	0.42	1.5	0.9	100	39.7
420	560	70	65	51	4	4	4	4	1020	2090	420	560	31984	458	436	528	528	549	13	28	0.41	1.5	0.81	106	41.7
	620	125	118	100	6	6	5	5	2300	5100	380	480	32084	473	444	572	572	600	13	28	0.37	1.6	0.88	120	125
460	860	210	190	160	7.5	7.5	7.5	7.5	5590	10100	350	470	30692	530	494	690	826	804	10	50	0.57	1.05	0.6	218	512
470	630	80	80	62	5	5	5	5	1410	3100	380	500	30694	498	487	580	582	603	10	26	0.319				66
480	950	240	225	174	9.5	9.5	9.5	9.5	6980	12500	310	420	30696	570	524	761	906	877	32	66	0.54	1.1	0.6	230	761
560	1080	265	235	208	9.5	9.5	9.5	9.5	8910	15700	180	270	306/560	660	604	887	1036	995	27	50	0.43	1.4	0.8	241	1063
600	720	73	69	56	3	3	3	3	1230	3320	380	480	306/600	680	613	680	682	703	20	30	0.365				53.0
610	820	105	95	80	6	6	6	6	1830	4200	360	450	306/610	661	630	741	743	777	20	37	0.374				139
630	850	132	132	95	6	6	6	6	3080	7150	360	450	329/630	675	649	766	832	821	13	37	0.46	1.3	0.72	168	200
710	950	114	106	80	6	6	6	6	2860	6900	260	360	319/710	774	729	864	932	909	13	34	0.46	1.3	0.72	175	210

# Metric Double Row Tapered Roller Bearings

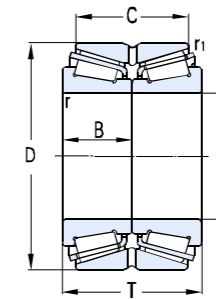
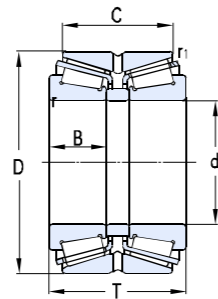

Basic dimensions							Basic load ratings		Limit speed		Designations	Calculation factor				Weight
d	D	T	B	C	rmin	r1min	Cr	Cor	Grease	Oil		e	Y1	Y2	Yo	
mm							KN		r/min			mm				Kg
50	90	55	23	43.5	1.5	0.6	320	220	3400	4500	352210	0.42	1.61	2.39	1.57	1.39
55	90	55	23	43.5	1.5	0.6	292	220	3300	4400	352210	0.42	1.61	2.39	1.57	1.37
70	125	74	31	61.5	2	0.6	310	495	2400	3200	352214	0.42	1.61	2.39	1.57	3.66
75	115	58	25	46	1.5	0.6	178	325	2400	3200	352015	0.46	1.47	2.19	1.44	2.04
80	125	66	29	52	1.5	0.6	238	430	2200	3000	352016	0.42	1.61	2.39	1.57	2.76
	170	94	39	63	3	1	405	560	2000	2600	351316	0.4	1.68	2.5	1.64	9.11
85	150	86	36	69	2.5	0.6	390	620	2000	2700	352217	0.42	1.61	2.39	1.57	5.94
	180	99	41	66	4	1	560	680	1900	2600	351317	0.83	0.82	1.22	0.8	11.1
90	190	103	43	70	4	1	530	760	1700	2200	351318	0.83	0.82	1.22	0.8	12.3
100	190	125	62.5	100	3	1.3	630	1050	1500	2000	350620D1	0.36	1.85	2.76	1.81	14.9
110	150	80	30	63	0.8	0.3	198	430	1300	1800	350622	0.37	1.82	2.72	1.78	3.61
	170	86	38	68	2.5	0.6	395	740	1300	1800	352022	0.43	1.57	2.34	1.53	6.65
	180	95	42	76	2	0.6	495	900	1200	1600	352122	0.32	2.09	3.11	2.04	9.10
115	230	116	49.5	84	3	2.5	685	1100	1300	1700	350623	0.72	0.94	1.4	0.9	20.2
120	180	88	38	70	2.5	0.6	405	785	1500	2000	352024	0.46	1.47	2.19	1.44	7.31
	200	110	48	90	2	0.6	605	1060	1500	2000	352124	0.3	2.25	3.43	2.2	12.6
	215	132	58	109	3	1	770	1390	1400	1900	352224	0.41	1.64	2.44	1.6	19.2
130	210	110	48	90	2	0.6	605	1070	1300	1700	352126	0.32	2.13	3.17	2.08	13.9
	230	145	64	117.5	4	1	890	1760	1300	1700	352226					24.0
	235	145	72.5	115	2.3	1.3	885	1560	1300	1700	350626D1	0.39	1.74	2.59	1.7	24.7
140	210	104	45	82	2.5	0.6	580	1170	1200	1700	352028	0.35	1.94	2.88	1.89	11.9
	225	115	50	90	2.5	1	640	1180	1200	1700	352128	0.34	2	2.98	1.96	15.5
150	225	112	45	88	3	1	1100	1690	1200	1500	350630	0.39	1.73	2.58	1.69	14.1
	250	138	60	112	2.5	1	865	1560	1100	1500	352130	0.25	2.74	4.08	2.68	25.8

# Metric Double Row Tapered Roller Bearings

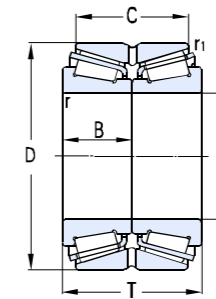
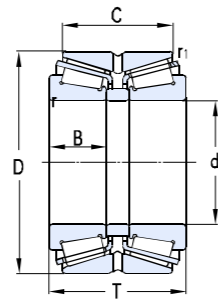

Basic dimensions							Basic load ratings		Limit speed		Designations	Calculation factor				Weight
d	D	T	B	C	rmin	r1min	Cr	Cor	Grease	Oil		e	Y1	Y2	Yo	
mm							KN		r/min			mm				Kg
	255	145	72.5	110	3	1.3	960	1840	1100	1500	350630D1	0.44	1.55	2.31	1.52	28.3
159.8	270	140	65	120	2.5	1	970	1930	1000	1400	3506/159.8	0.32	2.12	3.15	2.07	31.8
160	270	140	70	110	2.5	0.9	1720	2610	1000	1400	350632D1	0.36	1.86	2.76	1.81	26.7
165	290	150	70	125	3	1.3	1210	2300	920	1200	350633	0.31	2.2	3.27	2.15	41.1
170	280	150	66	120	2.5	1	1070	2000	950	1300	352134	0.38	1.78	2.65	1.74	35.6
180	280	142	64	110	3	1	1070	2220	940	1300	352036	0.42	1.61	2.39	1.57	29.8
	285	108	54	79.4	2.5	2.3	730	1190	940	1300	350636D1	0.35	1.95	2.9	1.91	23.2
	300	164	72	134	3	1	1200	2350	890	1200	352136	0.26	2.46	3.93	2.58	39.9
	340	180	83	140	5	1.1	1700	2860	840	1100	350636	0.35	1.96	2.91	1.91	71.9
200	280	116	51	92	3	1	750	1770	900	1200	352940	0.39	1.72	2.56	1.68	21.0
	310	154	70	120	3	1	1260	2620	840	1100	352040	0.43	1.57	2.34	1.53	41.9
	340	112	50.5	100	3	1.5	1070	1850	800	1100	350640	0.25	2.7	4.02	2.64	40.0
	340	184	82	150	3	1	1810	3400	800	1100	352140	0.25	2.74	4.08	2.68	63.8
220	370	195	88	150	4	1.3	1680	3200	760	1000	352144	0.37	1.83	2.72	1.79	76.3
	370	120	50	107	5	1.5	1130	1910	760	1000	350644	0.37	1.83	2.72	1.79	46.9
225	360	146.5	73.25	111	3	1.1	1280	2290	760	1000	350645D1	0.36	1.87	2.79	1.83	48.2
230	355	145	72.5	110	6	2.3	1180	2310	760	1000	350646D1	0.36	1.87	2.79	1.83	
240	400	210	95	163	3.7	1.3	2060	4050	630	840	352148	0.31	2.18	3.24	2.13	98.1
	400	128	59	114	5	1.5	1240	2270	720	1000	350648	0.43	1.55	2.31	1.52	60
260	360	141	63.5	110	3	1	1120	2550	670	900	352952	0.41	1.66	2.47	1.62	39.0
	430	180	90	130	7.5	2.3	1560	2990	630	840	350652D1	0.35	1.95	2.9	1.91	87.9
280	460	185	82	140	5	1.5	2130	4050	580	770	351156	0.33	2.05	3.05	2	114
	470	250		180	6.4	1.5	3430	6300	500	650	350656	0.46	1.5	2.2	1.4	156
300	400	140	62	100	5	1.5	1450	3000	560	740	350660	0.88	0.77	1.15	0.8	63.2

# Metric Double Row Tapered Roller Bearings

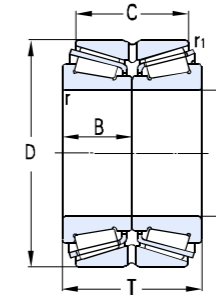
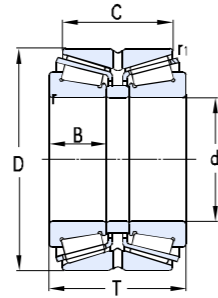

Basic dimensions							Basic load ratings		Limit speed		Designations	Calculation factor				Weight
d	D	T	B	C	rmin	r1min	Cr	Cor	Grease	Oil		e	Y1	Y2	Yo	
mm							KN		r/min			mm				Kg
	500	205	90	152	5	1.5	2400	4450	530	710	351160	0.32	2.12	3.15	2.077	141
320	480	151	66.5	121	5	1.5	1870	3550	530	710	350664	0.32	2.08	3.1	2.04	88.9
	480	220	100	186	5	1.1	2540	5750	530	710	352064	0.46	1.47	2.19	1.44	134
	540	225	100	160	5	1.5	3100	5700	510	660	351164	0.4	1.68	2.5	1.64	181
340	460	166	75	128	4	1.1	1540	4050	500	660	352968	0.31	2.15	3.2	2.1	72.3
	520	180	82	135	5	1.5	2060	4100	480	640	351068	0.29	2.35	3.5	2.3	127
	580	242	106	170	5	1.5	3100	6000	460	620	351168	0.42	1.6	2.38	1.56	235
360	540	185	82	140	5	1.5	2880	6300	460	620	351072	0.37	1.82	2.7	1.78	120
	600	242	106	170	5	1.5	3410	6800	400	520	351172	0.44	0.54	2.3	1.51	221
380	520	145	65	105	4	1.1	1660	3800	530	710	351976	0.38	1.77	2.64	1.73	78.8
	560	190	82	140	5	1.5	2880	6300	410	540	351076	0.39	1.75	2.61	1.71	137
	620	242	106	170	5	1.5	3410	6850	410	540	351176	0.46	1.47	2.18	1.43	250
	660	380		310	14	3.5	7620	15900	300	400	350676	0.33	2	3	2	521
400	540	150	65	105	4	1.1	1650	3850	530	710	351980	0.45	1.5	2.23	1.47	84.6
	600	206	90	150	5	1.5	2890	6300	410	540	351080	0.38	1.78	2.65	1.74	179
	650	255	112	180	6	2.5	3630	7400	360	480	351180	0.41	1.66	2.47	1.63	279
420	560	145	65	105	4	1.1	1880	4450	360	480	351984	0.38	1.77	2.64	1.73	87.0
	620	206	90	150	5	1.5	2670	5880	360	480	351084	0.41	1.64	2.44	1.6	191
440	600	170	74	125	4	1.1	2300	5300	400	520	351988	0.39	1.73	2.58	1.69	123
	650	212	94	152	6	2.5	3150	6900	360	480	351088	0.44	1.52	2.26	1.49	212
	720	275	122	190	6	2.5	4950	10400	360	480	351188	0.46	1.48	2.2	1.44	404
460	620	174	74	130	4	1	1960	5150	400	520	351992	0.4	1.69	2.51	1.65	134
	680	230	100	175	6	2.5	3410	7450	360	480	351092	0.31	2.18	3.24	2.13	253
480	650	180	78	130	5	1.5	2150	5150	360	480	351996	0.42	1.61	2.4	1.58	159
	790	310	136	224	7.5	3	6200	13300	250	320	351196	0.39	1.73	2.58	1.69	540
500	670	180	78	130	5	1.5	1470	6200	350	460	3519/500	0.43	1.55	2.31	1.52	158
	720	236	100	180	6	2.5	3580	8150	410	540	3510/500	0.32	2.08	3.1	2.04	276

# Metric Double Row Tapered Roller Bearings

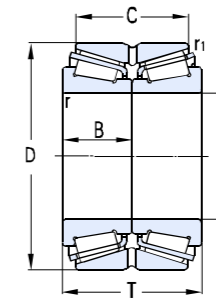
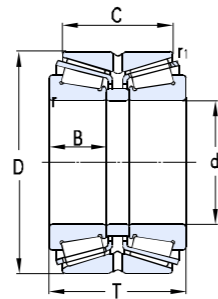

Basic dimensions							Basic load ratings		Limit speed		Designations	Calculation factor				Weight
d	D	T	B	C	r <sub>min</sub>	r <sub>1min</sub>	C <sub>r</sub>	C <sub>or</sub>	Grease	Oil		e	Y <sub>1</sub>	Y <sub>2</sub>	Y <sub>o</sub>	
mm							KN		r/min			mm				Kg
	720	236	118	180	6	2.5	3750	8500	410	540	3510/500D	0.32	2.08	3.1	2.04	276
530	710	190	82	136	5	1.5	2670	6300	320	420	3519/530	0.39	1.73	2.57	1.69	176
	780	255	112	180	6	2.5	4350	9850	320	420	3510/530	0.34	2	2.97	1.95	371
560	750	213	85	156	5	1.5	3410	8500	310	410	3519/560	0.43	1.57	2.34	1.53	232
	820	260	115	185	6	2.5	2920	5700	310	410	3510/560	0.4	1.7	2.54	1.67	434
600	800	205	90	156	5	1.5	3410	9050	290	390	3519/600	0.33	2.05	3.05	2	247
	870	270	118	198	6	2.5	5390	12700	280	380	3510/600	0.41	1.63	2.43	1.6	517
670	900	240	103	180	6	2.5	4200	11200	260	350	3519/670	0.44	1.53	2.28	1.5	378
710	950	240	106	175	6	2.5	4730	13200	250	320	3519/710	0.46	1.47	2.19	1.44	445
750	1000	264	112	194	6	2.5	5340	15600	230	310	3519/750	0.45	1.5	2.24	1.47	546
800	1060	270	115	204	6	2.5	6870	15200	220	300	3519/800	0.35	1.93	2.87	1.88	606
850	1120	268	118	188	6	2.5	6850	18700	210	270	3519/850	0.46	1.46	2.18	1.43	645
900	1180	275	122	205	6	2.5	7640	21300	200	260	3519/900	0.37	1.8	2.69	1.76	763
950	1250	300	132	220	7.5	3	7870	22500	180	240	3519/950	0.33	2.05	3.05	2	897
	1280	280	120	246	7.5	4	8300	22200	170	220	3506/950	0.4	1.68	2.5	1.64	974
1120	1460	335	158	250	7.5	3	9900	29500	160	210	3519/1120	0.35	1.93	2.87	1.88	1350
	1480	400		296	12	4	13200	37800	160	210	3506/1120	0.44	1.5	2.3	1.4	1763
1160	1540	400		290	12	4	14000	37900	140	190	3506/1160	0.44	1.5	2.3	1.4	1902
1250	1500	250		190	6	1.5	7350	22300	100	140	3506/1250	0.35	1.9	2.9	1.8	797
1370	1605	210	96	150	7.5	4	5150	20700	80	120	3506/1370	0.4	1.68	2.5	1.64	673

# Inch Single Row Tapered Roller Bearings

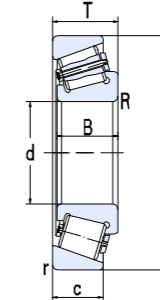
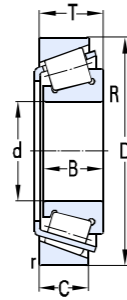

Basic dimensions												Basic load ratings		Limit speed		Designations	Calculation factor				Weight
d		D		T		B		C		rmin	Rmin	Cr	Cor	Grease	Oil		e	Y	Yo	a	
mm	in	mm	in	mm	in	mm	in	mm	in	mm		KN		r/min							Kg
20.625	0.812	49.225	1.938	23.02	0.9063	21.539	0.848	17.462	0.6875	1.5	1.5	37.5	37	8000	11000	K09081/K09196	0.27	2.26	1.24	12	0.197
21.43	0.8437	50.005	1.9687	17.526	0.69	18.288	0.72	13.97	0.55	1.3	1.3	45	43.5	8000	11000	KM12649/KM12610	0.28	2.16	1.19	11	0.169
		50.005	1.9687	17.526	0.69	18.288	0.72	13.97	0.55	1.3	1.3	45	43.5	8000	11000	K2M12649/K2M12610	0.28	2.16	1.19	11	0.169
21.979	0.8653	45.237	1.781	15.494	0.61	16.637	0.655	12.065	0.475	1.3	1.3	35.5	40	8000	10000	KLM12749/KLM12710	0.31	1.96	1.08	13	0.116
		45.974	1.81	15.494	0.61	16.637	0.655	12.065	0.475	1.3	1.3	29.5	34	8000	10000	KLM12749/KLM12711	0.31	1.96	1.08	13	0.118
22.225		50.8	2	15.011	0.591	14.26	0.5614	12.7	0.5	1.5	1.5	30.5	33	8000	10000	K07087X/K07210X	0.4	1.49	0.82	12	0.104
25.4	1	50.292	1.98	14.224	0.56	14.732	0.58	10.668	0.42	1.3	1.3	29.5	34	7500	10000	L44643/L44610	0.37	1.6	0.88	11	0.128
		50.8	2	15.011	0.591	14.26	0.5614	12.7	0.5	1.5	1.5	30.5	33	7500	10000	K07100S/K07210X	0.4	1.5	0.82	12	0.0908
		57.15	2.25	19.431	0.765	19.431	0.765	14.732	0.58	1.5	1.5	42	49	7500	10000	KM84548/KM84510	0.55	1.1	0.6	16	0.237
26*		57.15	2.25	17.462	0.6875	17.462	0.6875	13.495	0.5313	1.5	3.5	38	43.5	7500	10000	K15579X/K15520	0.35	1.73	0.95	19	0.207
26.988	1.0625	50.292	1.98	14.224	0.56	14.732	0.58	10.668	0.42	1.3	3.6	29.5	34	7500	10000	L44649/L44610	0.37	1.6	0.88	11	0.126
		63.5	2.5	20.638	0.8125	20.638	0.8125	15.875	0.625	1.5	0.8	46	53	7500	9000	K15106/K15250X	0.35	1.71	0.94	15	0.316
28*		57.15	2.25	17.462	0.6875	17.462	0.6875	13.495	0.5313	1.5	3.5	38	43.5	7000	9000	KJ15585/K15520	0.35	1.73	0.95	12	0.207
28.575	1.125	60.325	2.375	19.845	0.7813	19.355	0.762	15.875	0.625	1.3	3.5	39	42.5	7000	9000	K1988/K1931	0.33	1.82	1	13	0.244
		64.292	2.5312	21.433	0.8438	21.433	0.8438	16.67	0.6563	1.5	1.5	48.5	67.5	7000	9000	KM86647/KM86610	0.55	1.1	0.6	18	0.351
		66.421	2.615	23.812	0.9375	25.433	1.0013	19.05	0.75	1.3	1.3	68.5	77	7000	9000	K2689/K2631	0.26	2.28	1.25	14	0.420
		68.262	2.6875	22.225	0.875	22.225	0.875	17.462	0.6875	1.5	0.8	53.5	65	7000	9000	K02474/K02420	0.42	1.4	0.79	17	0.410
		73.025	2.875	22.225	0.875	22.225	0.875	17.462	0.6875	3.3	0.8	94.1	133	7000	9000	K02872/K02820	0.45	1.32	0.73	19	0.825
29	1.1417	50.292	1.98	14.224	0.56	14.732	0.58	10.668	0.42	1.2	3.6	29.5	34	7000	9000	L45449/L45410	0.37	1.62	0.89	11	0.118
30	1.811	72.085	2.838	22.385	0.8813	19.202	0.756	18.415	0.725	2.3	0.8	46	55.5	7000	8500	K14118/K14283	0.38	1.57	0.86	17	0.202
30.162	1.1875	62	2.4409	16.002	0.63	16.566	0.6522	14.288	0.5625	1.5	1.5	40	43.5	7000	8500	K17119/K17244B	0.38	1.57	0.86	14	0.228
		68.262	2.6875	22.225	0.875	22.225	0.875	17.462	0.6875	2.3	0.8	58.5	75	5600	7500	KM88043/KM88012	0.55	1.1	0.6	19	0.412
31.75	1.25	59.131	2.328	15.875	0.625	16.764	0.66	11.811	0.465	1.3	3.6	44	50	6300	8500	KLM67048/KLM67010	0.41	1.46	0.8	13	0.175
		62	2.4409	18.161	0.715	19.05	0.75	14.288	0.5625	1.3	4.8	56.5	62	6300	8500	K15123/K15245	0.35	1.71	0.94	13	0.242
		69.85	2.75	23.812	0.9375	25.357	0.9983	19.05	0.75	1.3	0.8	71.5	85.5	6300	8500	K2580/K2523	0.27	2.2	1.2	15	0.451

# Inch Single Row Tapered Roller Bearings

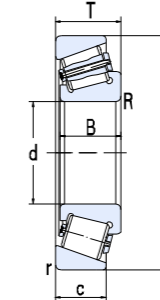
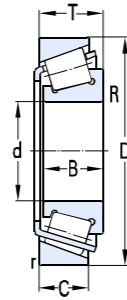

Basic dimensions												Basic load ratings		Limit speed		Designations	Calculation factor				Weight	
d		D		T		B		C		rmin	Rmin	Cr	Cor	Grease	Oil		e	Y	Yo	a		
mm	in	mm	in	mm	in	mm	in	mm	in	mm		KN		r/min							Kg	
33.338	1.3125	68.262	2.6875	22.225	0.875	22.225	0.875	17.462	0.6875	1.5	0.8	56	70.4	6300	7500	KM88048/KM88010	0.55	1.1	0.6	19	0.382	
		76.2	3	23.812	0.9375	25.654	1.01	19.05	0.75	1.5	3.3	90	110	5600	7500		K2790/K2720	0.3	1.98	1.09	16	0.559
		76.2	3	29.37	1.1563	28.575	1.125	23.02	0.9063	3.3	0.8	82	110	5600	7500		KHM89443/KHM89410	0.55	1.1	0.6	24	0.774
34.925	1.375	65.088	2.5625	18.034	0.71	18.288	0.72	13.97	0.55	1.3	3.6	49	60	5600	7500	KLM48548/KLM48510	0.38	1.59	0.88	14	0.260	
		65.088	2.5625	21.082	0.83	18.288	0.72	17.018	0.67	1.5	0.8	49	60	5600	7500	KLM48548A/KLM48511A	0.38	1.59	0.88	14	0.291	
		69.012	2.717	19.845	0.7813	19.583	0.771	15.875	0.625	3.5	0.8	51.2	55.5	5600	7500	K14138A/K14276B	0.38	1.57	0.86	15	0.333	
		72.233	2.8438	25.4	1	25.4	1	19.842	0.7812	2.3	2.3	70.5	80.5	5000	7100	KHM88649/KHM88610	0.55	1.1	0.6	21	0.480	
		73.025	2.875	23.812	0.9375	24.608	0.9688	19.05	0.75	0.8	1.5	71.5	85	5600	7500	K25877/K25821	0.29	2.07	1.14	14	0.475	
		76.2	3	29.37	1.1563	28.575	1.125	23.02	0.9063	3.3	3.5	82	110	5600	7500	KHM89446/KHM89410	0.55	1.1	0.6	24	0.670	
		76.2	3	29.37	1.1563	28.575	1.125	23.812	0.9375	3.3	1.5	82	98	5600	7500	K31594SH/K31520SH	0.4	1.49	0.82	21	2.13	
		79.375	3.125	29.37	1.1563	29.771	1.1721	23.812	0.9375	3.3	3.5	87.5	106	5600	7500	K3478/K3420	0.37	1.64	0.9	20	0.695	
		95.25	3.75	11.115	0.4376	29.9	1.1772	22.225	0.875	0.8	2.3	108	129	5600	7500	K449/K432B	0.28	2.11	1.16	19	1.16	
		35*		59.131	2.328	15.875	0.625	16.764	0.66	11.938	0.47	1.3	3.5	34	36	5600	7000	KL68149/KL68110	0.42	1.44	0.79	13
59.974	2.3612			15.875	0.625	16.764	0.66	11.938	0.47	1.3	3.5	34.5	24.5	5600	7000	KL68149/KL68111	0.42	1.44	0.79	13	0.166	
62*				16.7		17		13.6		1.5	SP	41.5	53.5	5600	7500	KLM78349/KLM78310A	0.44	1.4	0.74	14	0.206	
36.487	1.4365	76.2	3	23.812	0.9375	25.645	1.0096	19.05	0.75	3.3	1.5	90	110	5000	6700	K2780/K2720	0.3	2	1.1	16	0.526	
36.512		76.2	3	29.37	1.1563	28.575	1.125	23.02	0.9063	3.3	0.8	85	116	4800	6300	KHM89448/KHM89410	0.55	1.1	0.6	23	0.650	
		72.238	2.844	20.638	0.8125	20.638	0.8125	18.575	0.7313	1.3	3.5	45	61	4800	6300	K16143/K16284	0.4	1.49	0.82	17	0.362	
38.1	1.5	65.088	2.5625	18.034	0.71	18.288	0.72	13.97	0.55	1.3	2.3	44	57	5000	7000	KLM29749/KLM29710	0.33	1.8	0.99	12	0.237	
		69.012	2.717	26.195	1.0313	26.195	1.0313	15.083	0.5938	0.8	1.5	49.5	62	5000	7000	K13686/K13620	0.4	1.49	0.82	16	0.362	
		72.238	2.844	20.638	0.8125	20.638	0.8125	15.875	0.625	1.3	3.5	49.5	61	5000	7000	K16150/K16284	0.4	1.49	0.82	17	0.345	
		76.2	3	23.812	0.9375	25.654	1.01	19.05	0.75	3.3	3.5	90	110	5000	7000	K2788/K2720	0.3	1.98	1.09	17	0.507	
		79.375	3.125	29.37	1.1563	29.771	1.1721	23.812	0.9375	3.3	3.5	87	104	5000	7000	K3490/K3420	0.37	1.64	0.9	20	0.653	
		82.55	3.25	29.37	1.1563	28.575	1.125	23.02	0.9063	3.3	2.3	98	127	5000	7000	HM801346X/HM801310	0.55	1.1	0.6	25	0.770	
		88.5	3.4843	26.988	1.0625	29.083	1.145	22.225	0.875	1.5	3.5	100	113	5000	6000	K418/K414	0.26	2.28	1.25	18	0.843	
		88.5	3.4843	25.4	1	23.698	0.933	17.462	0.6875	1.5	2.3	76	86	5000	6000	K44150/K44348	0.78	0.77	0.42	28	0.718	
39*		72.014	2.8352	21.4	0.8425	20.638	0.8125	16.637	0.655	0.4	3.5	49.5	61	4500	6000	KJ16154/KJ16285	0.4	1.49	0.82	17	0.341	
39.688	1.5625	73.025	2.875	23.812	0.9375	25.654	1.01	19.05	0.75	0.8	3.5	90	110	4500	6000	K2789/K2735X	0.3	1.98	1.09	17	0.413	
		73.025	2.875	25.654	1.01	22.098	0.87	21.336	0.84	2.3	0.8	63.5	81.5	4500	6000	KM201047/KM201011	0.33	1.79	0.99	20	0.437	
		76.2	3	23.812	0.9375	25.654	1.01	19.05	0.75	0.8	3.5	90	110	4500	6000	K2789SH/K2729SH	0.3	1.98	1.09	16	0.507	



# Inch Single Row Tapered Roller Bearings

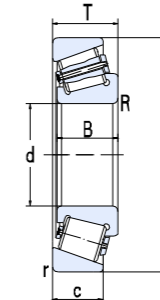
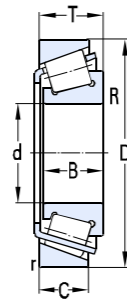

Basic dimensions												Basic load ratings		Limit speed		Designations	Calculation factor				Weight
d		D		T		B		C		rmin	Rmin	Cr	Cor	Grease	Oil		e	Y	Yo	a	
mm	in	mm	in	mm	in	mm	in	mm	in	mm		KN		r/min							Kg
		76.2	3	23.812	0.9375	25.645	1.0096	19.05	0.75	0.8	3.5	90	110	4500	6000	K2789/K2729	0.3	1.98	1.09	16	0.507
41*		68*	2.6772	17.5	0.689	18	7.087	13.5	0.5315	1.5	3.6	51	60	4500	6000	KLM300849/KLM300811	0.35	1.72	0.95	14	0.241
41.275	1.625	73.431	2.891	19.558	0.77	19.812	0.78	14.732	0.58	0.76	3.56	67	73.5	4500	6000	KLM501349/KLM501310	0.4	1.5	0.83	15	0.353
		73.431	2.891	21.43	0.8437	19.812	0.78	16.604	0.6537	0.8	3.5	67	73.5	4500	6000	KLM501349/KLM501314	0.4	1.5	0.83	17	0.360
		76.2	3	18.009	0.709	17.384	0.6844	14.288	0.5625	1.5	1.5	50.5	61.5	4500	6000	K11162/K11300	0.49	1.2	0.68	17	0.343
		76.2	3	22.225	0.875	23.02	0.9063	17.462	0.6875	0.8	3.5	71	83.5	4500	6000	K24780/K24720	0.4	1.5	0.84	17	0.429
		80	3.1496	21	0.8268	22.403	0.882	17.826	0.7018	1.3	0.8	68.5	76	4500	6000	K336/K332	0.27	2.2	1.21	15	0.453
		80.167	3.1562	29.37	1.1563	30.391	1.1965	23.812	0.9375	3.3	0.8	97	114	4500	6000	K3384/K3320	0.27	2.2	1.21	17	0.630
		80.167	3.1562	29.37	1.1563	30.391	1.1965	23.812	0.9375	3.3	0.8	97	114	4500	6000	K3379/K3320	0.27	2.2	1.21	17	0.630
		82.55	3.25	26.543	1.045	25.654	1.01	20.193	0.795	3.3	3.5	84	105	4500	6000	KM802048/KM802011	0.55	1.1	0.6	23	0.623
		84.138	3.3125	30.162	1.1875	30.886	1.216	23.812	0.9375	3.3	1.5	105	143	4500	6000	K3585/K3520	0.53	1.14	0.62	25	0.792
		85.725	3.375	30.162	1.1875	30.162	1.1875	23.812	0.9375	SP	3.5	101	130	4500	6000	K3877/K3826B	0.4	1.49	0.82	22	0.862
		87.312	3.4375	30.162	1.1875	30.866	0.9375	23.812	1.2452	1.5	3.3	129	175	4500	6000	K3585/K3525	0.53	1.14	0.62	24	0.861
		88.5	3.4843	26.988	1.0625	29.083	1.145	22.225	0.875	1.5	3.5	100	113	5000	6000	K419/K414	0.26	2.28	1.25	18	0.804
		88.9	3.5	30.162	1.1875	29.37	1.1563	23.02	0.9063	3.3	3.5	90.5	125	4300	5600	KHM803146/KHM803110	0.54	1.1	0.6	26	0.915
		104.775	4.125	36.512	1.4375	36.512	1.4375	28.575	1.125	3.3	1.5	146	194	4300	5600	K59162/K59412	0.4	1.49	0.82	26	1.69
42.862	1.6875	82.55	3.25	26.195	1.0313	26.988	1.0625	20.638	0.8125	3.3	3.5	84.5	119	4500	6000	K22780/K22720	0.4	1.49	0.82	20	0.687
42.875	1.688	80	3.1496	21	0.8268	22.403	0.882	17.826	0.7018	2	3.5	69	76	4500	6000	K342S/K332US	0.27	2.2	1.21	15	0.432
		82.931	3.265	26.988	1.0625	25.4	1	22.225	0.875	2.3	3.5	78	101	4500	6000	K25577/K25523	0.33	1.79	0.99	19	0.646
43*		80*		21.001	0.8268	22.403	0.882	17.826	0.7018	0.8	3.5	69	76	4500	6000	K342X/K332B	0.27	2.2	1.21	15	0.440
44.45	1.75	82.931	3.265	23.812	0.9375	25.4	1	19.05	0.75	0.8	3.5	77	100	4500	6000	K25580/K25520	0.33	1.79	0.99	18	0.573
		90.119	3.548	23	0.9055	21.692	0.854	21.808	0.8586	2.3	3.5	71.5	85	4500	6000	K355X/K352	0.31	1.96	1.08	18	0.668
		93.264	3.6718	30.162	1.1875	30.302	1.193	23.812	0.9375	3.3	3.5	103	140	4500	6000	K3782/K3720	0.34	1.77	0.98	22	1.04
		95.25	3.75	30.958	1.2188	28.575	1.125	22.225	0.875	0.8	3.5	111	133	4500	6000	KHM903249/KHM903210	0.74	0.81	0.45	32	1.00
		95.25	3.75	27.783	1.0938	28.575	1.125	22.225	0.875	0.8	0.8	110	140	3800	5300	K33885/K33822	0.33	1.79	0.99	24	0.983
		101.6	4	34.925	1.375	36.068	1.42	26.988	1.0625	3.3	3.5	136	168	4500	6000	K527/K522	0.29	2.1	1.16	22	1.36
		104.775	4.125	36.512	1.4375	36.512	1.4375	28.575	1.125	3.3	3.5	146	194	4300	5600	K59175/K59412	0.4	1.49	0.82	26	1.63
		44.988	1.7712	104.986	4.1333	32.512	1.28	31.75	1.25	23.368	0.92	2.5	2.5	127	164	4500	6000	KHM905843/KHM905810	0.78	0.77	0.42
45.23	1.7807	79.985	3.149	19.842	0.7812	20.638	0.8125	15.08	0.5937	2	1.3	58	76	4500	6000	K17887/K17831	0.37	1.64	0.9	16	0.406

# Inch Single Row Tapered Roller Bearings

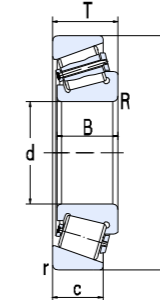
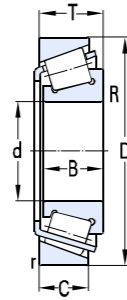

Basic dimensions												Basic load ratings		Limit speed		Designations	Calculation factor				Weight	
d		D		T		B		C		rmin	Rmin	Cr	Cor	Grease	Oil		e	Y	Yo	a		
mm	in	mm	in	mm	in	mm	in	mm	in	mm		KN		r/min							Kg	
45.242	1.7812	73.431	2.891	19.558	0.77	19.812	0.78	15.748	0.62	0.8	3.5	51.5	70	4500	6000	KLM102949/KLM102910	0.31	1.97	1.08	14	0.318	
		77.788	3.0625	21.43	0.8437	19.842	0.7812	16.667	0.6562	0.8	3.5	51	71	4800	6300		KLM603049/KLM603012	0.43	1.4	0.77		19
45.618	1.796	82.931	3.265	23.812	0.7375	25.4	1	19.05	0.75	0.8	3.5	77	100	4500	6000	K25590/K25520	0.33	1.79	0.99	18	0.556	
		82.931	3.265	26.988	1.0625	25.4	1	22.225	0.875	2.3	3.5	77	100	4500	6000	K25590/K25523	0.33	1.79	0.99	18		0.589
		83.058	3.27	23.876	0.94	25.4	1	19.114	0.7525	2	3.5	77	100	4500	5000	K25590/K25522	0.33	1.79	0.99	18		0.556
46.038	1.8125	79.375	3.125	17.462	0.6875	17.462	0.6875	13.495	0.5313	1.5	2.8	48	60	4500	6000	K18690/K18620	0.37	1.6	0.88	16	0.325	
		85	3.3465	20.638	0.8125	21.692	0.854	17.462	0.6875	1.3	2.3	73	83	4500	6000	K359S/K354A	0.31	1.9	1.1	16		0.770
47.625	1.875	93.264	3.6718	30.162	1.1875	30.302	1.193	23.812	0.9375	3.3	3.5	103	140	3800	5300	K3779/K3720	0.34	1.77	0.98	21	0.921	
		95.25	3.75	30.162	1.1875	29.37	1.1563	23.02	0.9063	3.3	3.5	107	144	3800	5300	KHM804846/KHM804810	0.55	1.1	0.6	26		0.987
		123.825	4.875	36.512	1.4375	32.791	1.291	25.4	1	3.3	3.5	142	189	3000	4000	K72187C/K72487	0.74	0.81	0.45	37		2.25
50*	1.9685	82*		21.976		21.501	0.8465	17		0.5	3	61.5	84	4000	5000	KJM104948/KJLM104910	0.31	1.97	1.08	16	0.425	
		83*	3.3071	22	0.8661	22	0.8661	17.5	0.689	1.5	3.5	71	96.5	4000	5000	KJLM704649/KJLM704610	0.44	1.37	0.75	20		0.474
		90*		28		28	1.1024	23		2.5	3	121	140	4000	5000	JM205149/JM205110	0.33	1.83	1.01	20		0.758
		93.264	3.6718	30.162	0.1875	30.302	1.193	23.812	0.9375	3.3	3.5	113	136	4000	5000	K50KW01/K3720	0.34	1.77	0.98	23		0.928
		105*		37		36		29		3	2.5	140	192	4000	5000	KJHM807045/KJHM807012	0.49	1.23	0.68	29		1.39
50.8	2	82	3.2283	21.967	0.8648	22.225	0.875	17	0.6693	0.5	3.5	68.5	84	4500	6000	KLM104949/KLM104910	0.3	2	1.1	16	0.422	
		82.55	3.25	21.59	0.85	22.225	0.875	16.51	0.65	1.3	3.5	68.5	84	4500	6000	KLM104949/KLM104911	0.31	1.97	1.08	16		0.417
		85	3.3465	17.462	0.6875	17.462	0.6875	13.495	0.5313	1.5	3.5	50.5	66.5	4000	5000	K18790/K18720	0.41	1.48	0.81	63		0.378
		88.9	3.5	20.638	0.8125	22.225	0.875	16.513	0.6501	1.3	3.5	75.5	89	4000	5000	K368A/K362A	0.32	1.88	1.03	17		0.520
		90	3.5433	25	0.9843	22.225	0.875	20	0.7874	2	3.5	75.5	89	4000	5000	K368A/K362X	0.32	1.88	1.03	17		0.601
		92.075	3.625	24.608	0.9688	25.4	1	19.845	0.7813	0.8	3.5	86.5	119	4000	5000	K28580/K28521	0.38	1.59	0.88	18		0.701
		93.264	3.6718	30.162	1.1875	30.162	1.1875	23.812	0.9375	0.8	0.8	124	158	4000	5000	K3775/K3730	0.34	1.77	0.98	22		0.870
		93.264	3.6718	30.162	1.1875	30.162	1.1875	23.812	0.9375	3.3	3.5	124	158	4000	4500	K3780/K3720	0.34	1.77	0.98	22		0.870
		95.25	3.75	27.783	1.0938	28.575	1.125	22.225	0.875	0.8	3.5	110	140	4000	4500	K33889/K33822	0.33	1.79	0.99	24		0.877
		101.6	4	31.75	1.25	31.75	1.25	25.4	1	0.8	3.5	120	151	4000	4500	K49585/K49522	0.4	1.5	0.82	23		
		104.775	4.125	36.512	1.4375	36.512	1.4375	28.575	1.125	3.3	3.5	140	192	3500	4500	KHM807046/KHM807010	0.49	1.23	0.68	29		1.48
		104.775	4.125	36.512	1.4375	36.512	1.4375	28.575	1.125	3.3	3.5	146	194	3500	4500	K59200/K59412	0.4	1.49	0.82	26		1.49
		104.775	4.125	30.162	1.1875	30.958	1.2188	23.812	0.9375	3.3	0.8	127	166	3500	4500	K45285ASH/K45220SH	0.33	1.8	0.99	26		1.23
		104.775	4.125	30.162	1.1875	30.958	1.2188	23.812	0.9375	3.3	6.4	127	166	3500	4500	K45284/K45220	0.33	1.8	0.99	26		1.23
		107.95	4.25	27.783	1.0938	29.317	1.1542	22.225	0.875	0.8	0.8	110	143	3500	4500	K455/K453A	0.34	1.79	0.98	21		1.24
		107.95	4.25	27.795	1.0943	29.317	1.1542	27	1.063	0.8	0.8	110	143	3500	4500	K455/K453	0.34	1.79	0.98	21		1.30
		123.825	4.875	36.512	1.4375	32.791	1.291	25.4	1	3.3	3.5	142	189	2800	4000	K72200C/K72487	0.74	0.81	0.45	38		2.13

# Inch Single Row Tapered Roller Bearings

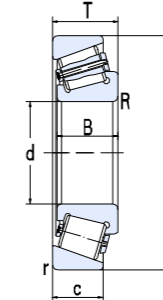
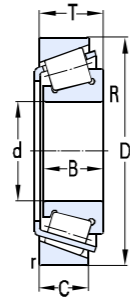

Basic dimensions												Basic load ratings		Limit speed		Designations	Calculation factor				Weight
d		D		T		B		C		rmin	Rmin	Cr	Cor	Grease	Oil		e	Y	Yo	a	
mm	in	mm	in	mm	in	mm	in	mm	in	mm		KN		r/min							Kg
51.75	2.0374	104.775	4.125	30.162	1.1875	29.317	1.1542	24.605	0.9687	3.3	2.3	100	145	3500	4500	K462/K453X	0.34	1.79	0.98	25	1.05
52.388	2.0625	92.075	3.625	24.608	0.9688	25.4	1	19.845	0.7813	0.8	3.5	86.5	119	3500	4000	K28584/K28521	0.38	1.59	0.88	18	0.678
		95.25	3.75	27.783	1.0938	28.575	1.125	22.225	0.875	2.3	3.5	109	140	3000	4000	K33891/K33821	0.33	1.82	1	20	0.811
53.975	2.125	95.25	3.75	27.783	1.0938	28.575	1.125	22.225	0.875	0.8	1.5	109	140	3000	4000	K33895/K33822	0.33	1.82	1	20	0.819
		100	3.937	21	0.8268	21.946	0.864	17.862	0.7032	2	0.8	82.5	103	3000	4000	K389A/K383A	0.35	1.69	0.93	19	0.692
		107.95	4.25	36.512	1.4375	36.957	1.455	28.575	1.125	0.5	3.5	153	190	3000	4000	K539/K532XA6	0.3	2.02	1.11	23	1.47
		123.825	4.875	36.512	1.4375	32.791	1.291	25.4	1	3.3	3.5	142	189	2800	4000	K72212C/K72487	0.74	0.81	0.45	38	2.12
		130.175	5.125	36.512	1.4375	33.338	1.3425	23.812	0.9375	3.3	3.5	176	210	3000	4000	KHM911242/KHM911210	0.81	0.74	0.41	41	2.24
54.488	2.1452	104.775	4.125	36.512	1.4375	36.512	1.4375	28.575	1.125	3.3	3.5	140	192	3000	4000	KHM807048/KHM807010	0.49	1.23	0.68	29	1.39
55*	2.1654	90*		23		23		18.5		0.5	1.5	78	113	3000	4000	KJLM506849/KJLM506810	0.4	1.5	0.82	20	0.568
		95*		29		29		23.5		2.5	1.5	77	152	3000	4000	KJM207049/KJM207010	0.33	1.8	0.99	21	0.831
		110*		39		39		32		2.5	3	164	203	3000	4000	KJH307749/KJH307710	0.35	1.69	0.93	26	1.69
55.562	2.1875	97.63	3.837	24.608	0.9688	24.608	0.9688	19.446	0.7656	0.8	3.5	89.5	129	3000	4000	K28680/K28622	0.4	1.49	0.82	21	0.760
57.15	2.25	96.838	3.8125	21	0.8268	21.946	0.864	15.875	0.625	0.8	3.5	82.5	103	3000	4000	K387A/K382A	0.35	1.7	0.9	21	0.581
		100	3.937	21	0.8268	21.946	0.864	17.826	0.7018	2	0.8	82.5	103	3000	4000	K387S/K383A	0.35	1.69	0.93	19	0.653
		112.712	4.4375	30.162	1.1875	30.048	1.183	23.812	0.9375	3.3	3.5	139	198	3000	4000	K3979/K3920	0.35	1.7	0.93	24	1.46
		112.712	4.4375	30.162	1.1875	30.162	1.1875	23.812	0.9375	3.3	8	141	201	3000	4000	K39581/K39520	0.35	1.7	0.93	24	1.42
		140.03	5.513	36.512	1.4375	33.236	1.3085	23.52	0.926	2.3	3.5	155	185	3000	4000	K78225C/K78551	0.87	0.69	0.38	45	2.53
59.987	2.3617	146.05	5.75	41.275	1.625	39.688	1.5625	25.4	1	3.3	3.5	206	240	3000	4000	KH913840/KH913810-3	0.78	0.77	0.42	45	3.28
60*	2.3346	112.712	4.4375	30.162	1.1875	30.048	1.183	23.812	0.9375	3.3	3.5	115	170	3000	4000	K3977/K3920	0.4	1.49	0.82	25	1.30
		135	5.3147	33.45	1.3169	30.95	1.2185	22	0.8661	3.5	3.5	137	175	3000	4000	KHM911244B/KHM911216B	0.82	0.73	0.4	41	2.06
		146.05	5.75	41.275	1.625	39.688	1.5625	25.4	1	3.3	3.5	206	240	3000	4000	KH913840/KH913810	0.78	0.77	0.42	45	3.28
60.325	2.375	100	3.937	25.4	1	25.4	1	19.845	0.7813	3.3	3.5	95	75.5	3000	4000	K28985/K28921	0.43	1.41	0.77	24	0.812
		101.6	4	25.4	1	25.4	1	19.845	0.7813	3.3	3.5	95	75.7	3000	4000	K28985/K28920	0.43	1.41	0.77	24	0.851
		122.238	4.8125	38.1	1.5	38.354	1.51	29.718	1.17	3.3	8	233	154	3000	4000	KHM212044/KHM212011	0.34	1.78	0.98	31	2.08
		123.825	4.875	38.1	1.5	36.678	1.444	30.162	1.1875	3.3	2.3	162	223	3000	4000	K558/K552A	0.35	1.73	0.95	31	2.09
		127	5	44.45	1.75	44.45	1.75	34.925	1.375	3.3	3.5	211	274	3000	4000	K65237/K65500	0.49	1.2	0.68	35	2.65

# Inch Single Row Tapered Roller Bearings

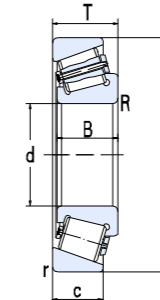
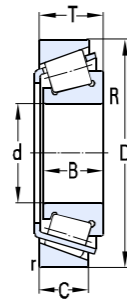

Basic dimensions												Basic load ratings		Limit speed		Designations	Calculation factor				Weight
d		D		T		B		C		rmin	Rmin	Cr	Cor	Grease	Oil		e	Y	Yo	a	
mm	in	mm	in	mm	in	mm	in	mm	in	mm		KN		r/min							Kg
61.912	2.4375	112.712	4.4375	26.967	1.0617	21.996	0.866	23.812	0.9375	3.3	0.8	91	105	3000	4000	K392/K3920	0.4	1.49	0.82	27	1.06
		127	5	36.512	1.4375	36.512	1.4375	26.988	1.0625	3.3	3.5	166	234	2600	3400	KHM813843/KHM813810	0.5	1.2	0.66	37	2.16
		136.525	5.375	46.038	1.8125	46.038	1.8125	36.512	1.4375	3.3	3.5	249	405	2600	3400	KH715334/KH715311	0.47	1.3	0.7	37	3.41
63.5	2.5	94.458	3.7188	19.05	0.75	19.05	0.75	15.083	0.5938	1.5	1.5	62	105	3000	4000	KL610549/KL610510	0.42	1.4	0.78	20	0.453
		104.775	4.125	21.433	0.8438	22	0.8661	15.875	0.625	2.0	2.0	92.5	119	3000	4000	K39250/K39412	0.39	1.6	0.86	20	0.711
		107.95	4.25	25.4	1	25.4	1	19.05	0.75	3.3	1.5	92.5	141	3000	4000	K29586/K29520	0.46	1.31	0.72	18	0.914
		107.95	4.25	25.4	1	25.4	1	19.05	0.75	0.8	1.5	92.5	141	3000	4000	K29586/K29522	0.46	1.31	0.72	24	0.914
		107.95	4.25	25.4	1	25.4	1	19.05	0.75	0.8	3.5	92.5	141	3000	4000	K29585/K29522	0.46	1.31	0.72	24	0.914
		110	4.3307	22	0.8661	21.996	0.866	18.824	0.7411	1.3	3.5	90	117	3000	4000	K395/K394A	0.4	1.5	0.82	21	0.853
		110	4.3307	25.4	1	25.4	1	19.05	0.75	1.3	3.5	92.5	141	3000	4000	K29585/K29521	0.46	1.31	0.72	24	0.965
		112.712	4.4375	30.162	1.1875	30.048	1.183	23.812	0.9375	3.3	3.5	116	170	2900	3900	K3982/K3920	0.4	1.49	0.82	24	1.22
		112.712	4.4375	30.162	1.1875	30.162	1.1875	23.812	0.9375	3.3	3.5	154	201	2900	3900	K39585/K39520	0.35	1.7	0.93	24	1.27
		122.238	4.8125	38.1	1.5	38.354	1.51	29.718	1.17	3.3	7	190	250	2900	3900	KHM212047/KHM212011	0.34	1.78	0.98	24	1.90
		123.825	4.875	38.1	1.5	36.678	1.444	30.162	1.1875	3.3	3.5	162	223	2900	3900	K559/K552A	0.35	1.73	0.95	29	1.99
		127	5	36.512	1.4375	36.512	1.4375	26.988	1.0625	3.3	3.5	166	234	2900	3900	KHM813842/KHM813810	0.5	1.2	0.66	32	2.12
		136.525	5.375	41.275	1.625	41.275	1.625	31.75	1.25	3.3	3.5	264	340	2800	3800	KH414235/KH414210	0.36	1.66	0.91	30	3.03
		65*		110*		28		28		22.5		2.5	3	131	181	2800	3800	KJM511946/KJM511910	0.4	1.49	0.82
120*				39		38.5	1.5157	32		2.5	3	187	250	2800	3800	KJM211749/KJM211710	0.34	1.78	0.98	27	0.86
65.088	2.5625	135.755	5.3447	53.975	2.125	56.007	2.205	44.45	1.75	3.3	3.5	272	355	2600	3400	K6379/K6320	0.32	1.88	1.02	36	3.63
66.675	2.625	107.95	4.25	25.4	1	25.4	1	19.05	0.75	0.8	3.5	92.5	141	2800	3800	K29590/K29522	0.46	1.31	0.72	18	0.853
		110	4.3307	22	0.8661	21.996	0.866	18.824	0.7411	1.3	0.8	90	117	2800	3800	K395A/K394A	0.4	1.49	0.82	21	0.797
		112.712	4.4375	30.162	1.1875	30.048	1.183	23.812	0.9375	3.3	3.5	117	170	2800	3800	K3984/K3920	0.4	1.49	0.82	24	1.17
		112.712	4.4375	30.162	1.1875	30.162	1.1875	23.812	0.9375	3.3	3.5	141	201	2800	3800	K39590/K39520	0.35	1.7	0.93	24	1.23
		117.475	4.625	30.162	1.1875	30.162	1.1875	23.812	0.9375	3.3	3.5	123	180	2800	3800	K33262/K33462	0.44	1.38	0.76	28	1.37
		122.238	4.8125	38.1	1.5	38.354	1.51	29.718	1.17	3.3	3.6	233	154	2800	3800	KHM212049/KHM212011	0.34	1.78	0.98	24	1.90
		122.238	4.8125	38.1	1.5	38.354	1.51	29.718	1.17	1.5	3.5	233	154	2800	3800	KHM212049/KHM212010	0.34	1.78	0.98	27	1.90
		136.525	5.375	41.275	1.625	41.275	1.625	31.75	1.25	3.3	3.5	199	271	2600	3400	K641/K632	0.36	1.66	0.91	30	2.74
		136.525	5.375	46.038	1.8125	46.038	1.8125	36.512	1.4375	3.3	3.5	249	405	2600	3400	KH715341/KH715311	0.47	1.3	0.7	37	3.24
		68.262	2.6875	136.525	5.375	41.275	1.625	41.275	1.625	31.75	1.25	3.3	3.5	199	271	2600	3400	K642/K632	0.36	1.66	0.91
136.525	5.375			46.038	1.8125	46.038	1.8125	36.512	1.4375	3.3	3.5	238	380	2600	3400	KH715343/KH715311	0.47	1.3	0.7	37	3.18
161.925	6.375			49.212	1.9375	46.038	1.8125	31.75	1.25	3.3	3.5	248	490	2800	3800	K9278/K9220	0.71	0.85	0.47	56	4.58

# Inch Single Row Tapered Roller Bearings

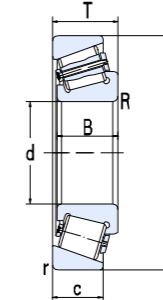
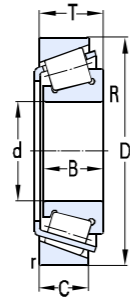

Basic dimensions												Basic load ratings		Limit speed		Designations	Calculation factor				Weight
d		D		T		B		C		rmin	Rmin	Cr	Cor	Grease	Oil		e	Y	Yo	a	
mm	in	mm	in	mm	in	mm	in	mm	in	mm		KN		r/min							Kg
69.85	2.75	120	4.7244	29.795	1.173	29.007	1.142	24.237	0.9542	2	3.5	135	188	2800	3800	K482/K472	0.38	1.56	0.86	26	1.32
		120	4.7244	32.545	1.2813	32.545	1.2813	26.195	1.0313	3.3	3.5	157	229	3000	4000	K47487/K47420	0.35	1.7	0.9	25	1.50
		130.175	5.125	41.275	1.625	41.275	1.625	31.75	1.25	3.3	3.5	199	271	2600	3600	K643/K633	0.36	1.66	0.91	29	2.30
		146.05	5.75	41.275	1.625	39.688	1.5625	25.4	1	3.3	3.5	206	240	2600	3600	KH913849/KH913810	0.78	0.77	0.42	45	2.97
		112.712	4.4375	25.4	1	25.4	1	19.05	0.75	3.3	1.5	98	156	2600	3600	K29675/K29620	0.49	1.23	0.68	26	0.952
70*	2.7559	110*		26		25		20.5		2.5	1	102	156	3000	4000	KJLM813049/KJLM813010	0.49	1.23	0.68	26	0.894
		120	4.7244	29.795	1.173	29.007	1.142	24.237	0.9542	2	2	135	188	3000	4000	K484/K472	0.38	1.6	0.86	25	1.32
71.438	2.8125	117.475	4.625	30.162	1.1875	30.162	1.1875	23.812	0.9375	3.3	3.5	118	180	2600	3600	K33281/K33462	0.44	1.38	0.76	28	1.24
		120	4.7244	32.545	1.2813	32.545	1.2813	26.195	1.0313	3.3	3.5	157	229	2600	3600	K47490/K47420	0.36	1.66	0.92	26	1.46
		136.525	5.375	41.275	1.625	41.275	1.625	31.75	1.25	3.3	3.5	242	300	2600	3600	KH414249/KH414210	0.36	1.66	0.92	31	2.59
		136.525	5.375	41.275	1.625	41.275	1.625	31.75	1.25	3.3	6.4	199	271	2600	3600	K645/K632	0.36	1.66	0.91	33	2.55
73.025	2.875	112.712	4.4375	25.4	1	25.4	1	19.05	0.75	3.3	3.5	98	156	2600	3600	K29685/K29620	0.49	1.23	0.68	25	0.878
		117.475	4.625	30.162	1.1875	30.162	1.1875	23.812	0.9375	3.3	3.5	118	180	2600	3600	K33287/K33462	0.44	1.38	0.76	28	1.21
		150.089	5.909	44.45	1.75	46.672	1.8375	36.512	1.4375	3.3	3.5	264	365	2400	3400	K744/K742	0.33	1.84	1.01	31	3.74
75*		115*		25		25		19		2.5	3	105	152	2600	3600	KJLM714149/KJLM714110	0.46	1.3	0.72	25	8.58
		120*		31		29.5		25		2.5	3	128	204	2600	3600	KJM714249/KJM714210	0.44	1.35	0.74	28	1.28
75.987	2.9916	131.976	5.1959	39	1.5354	39	1.5354	32	1.2598	3.5	7	203	305	2600	3600	KHM215249/KHM215210	0.33	1.84	1.01	28	2.14
76.2	3	125.412	4.9375	25.4	1	25.4	1	19.845	0.7813	1.5	3.5	91	160	2600	3600	K27684/K27620	0.45	1.32	0.73	29	1.25
		127	5	30.162	1.1875	31	1.2205	22.225	0.875	3.3	3.5	184	220	2600	3600	K42687/K42620	0.42	1.43	0.79	27	1.44
		127	5	30.162	1.1875	31	1.2205	22.225	0.875	3.3	6.4	184	220	2600	3600	K42688/K42620	0.42	1.43	0.79	27	1.44
		135.733	5.3438	44.45	1.75	46.1	1.815	34.925	1.375	3.3	3.5	215	340	2600	3600	K5760/K5735	0.41	1.5	0.81	33	2.73
		136.525	5.375	30.162	1.1875	29.769	1.1716	22.225	0.875	3.175	3.5	134	198	2400	3400	K495A/K493	0.44	1.35	0.74	29	1.82
		139.992	5.5115	36.512	1.4375	36.098	1.4212	28.575	1.125	3.302	3.5	187	290	2400	3400	K575/K572	0.4	1.49	0.82	32	2.44
		150.089	5.909	44.45	1.75	46.672	1.8375	36.512	1.4375	3.3	3.5	264	365	2400	3400	K748S/K742	0.33	1.84	1.01	33	3.62
		161.925	6.375	47.625	1.875	48.26	1.9	38.1	1.5	3.3	3.5	273	390	2400	3400	K755/K752	0.34	1.76	0.97	40	4.85
		161.925	6.375	53.975	2.125	55.1	2.1693	42.862	1.6875	3.3	3.5	315	475	2400	3400	K6576/K6535	0.4	1.49	0.82	41	5.46
		171.45	6.75	49.212	1.9375	46.038	1.8125	31.75	1.25	3.3	3.5	267	325	2000	2800	K9380/K9321	0.76	0.79	0.43	54	5.20
		180.975	7.125	53.975	2.125	53.183	2.0938	35.72	1.4063	3.3	3.5	207	210	2000	2800	KH917840/KH917810	0.73	0.82	0.45	63	6.56
77.788	3.0625	135.733	5.3438	44.45	1.75	46.1	1.815	34.925	1.375	3.3	3.5	215	340	2600	3600	K5795/K5735	0.41	1.5	0.81	33	2.73

# Inch Single Row Tapered Roller Bearings

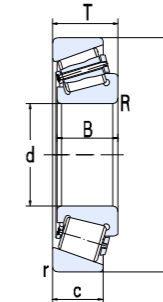
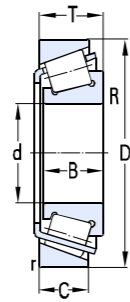

Basic dimensions												Basic load ratings		Limit speed		Designations	Calculation factor				Weight
d		D		T		B		C		rmin	Rmin	Cr	Cor	Grease	Oil		e	Y	Yo	a	
mm	in	mm	in	mm	in	mm	in	mm	in	mm		KN		r/min							Kg
80*		130*		35		34		28.5		2.5	3	175	280	2400	3400	KJM515649/KJM515610	0.41	1.48	0.81	30	1.82
80.962	3.1875	136.525	5.375	30.162	1.1875	29.769	1.172	22.225	0.875	3.175	3.503	134	198	2400	3400	K496/K493	0.44	1.35	0.74	29	1.75
82.55	3.25	125.412	4.9375	25.4	1	25.4	1	19.845	0.7813	1.5	3.5	140	151	2400	3400	27687/27620	0.45	1.32	0.73	27	1.10
		133.35	5.25	33.338	1.3125	33.338	1.3125	26.195	1.0313	3.3	6.8	142	218	2400	3400	K47687/K47620	0.4	1.48	0.82	28	1.74
		133.35	5.25	33.338	1.3125	33.338	1.3125	26.195	1.0313	3.3	3.5	142	218	2400	3400	K47686/K47620	0.4	1.48	0.82	28	1.80
		133.35	5.25	39.688	1.5625	39.688	1.5625	32.545	1.2813	3.3	3.5	186	310	2400	3400	KHM516449/KHM516410	0.4	1.48	0.82	32	2.12
		139.7	5.5	36.512	1.4375	36.098	1.4212	28.575	1.125	3.3	3.556	187	290	2400	3400	K580/K572X	0.4	1.48	0.82	31	2.21
		139.992	5.5115	36.512	1.4375	36.098	1.4212	28.575	1.125	3.302	3.556	217	275	2400	3400	K580/K572	0.4	1.49	0.82	31	2.21
		146.05	5.75	41.275	1.625	41.275	1.625	31.75	1.25	3.505	0.254	265	360	2400	3400	K663/K653	0.41	1.47	0.81	36	2.87
		150	5.9055	44.45	1.75	46.672	1.8375	36.512	1.4375	3.3	3.5	264	365	2400	3400	K749A/K742A	0.33	1.84	1.01	38	3.33
180.975	7.125	53.975	2.125	53.183	2.093818898	35.72	1.406299213	3.3	3.3	207	210	2000	3000	KH917849/KH917810	0.73	0.82	0.45	50	6.25		
83.345	3.2813	125.412	4.9375	25.4	1	25.4	1	19.845	0.7813	1.5	3.5	100	160	2400	3400	K27690/K27620	0.42	1.44	0.79	26	1.08
84.138	3.3125	133.35	5.25	30.162	1.1875	29.769	1.172	22.225	0.875	3.3	3.5	134	198	2400	3400	K498/K492A	0.44	1.35	0.74	29	1.47
84.976	3.3455	125.412	4.9375	25.4	1	25.4	1	19.845	0.7813	1.5	5	100	160	2400	3400	K27695/K27620	0.45	1.32	0.73	31	1.01
85*		130*		30		29		24		2.5	3	138	216	2400	3400	KJM716649/KJM716610	0.44	1.35	0.74	30	1.39
85.026	3.3475	150.089	5.909	44.45	1.75	46.672	1.8375	36.512	1.4375	3.3	3.5	264	365	2400	3400	K749/K742	0.33	1.84	1.01	31	3.22
85.725	3.375	136.525	5.375	30.163	1.1875	29.769	1.172	22.225	0.875	3.175	3.556	134	198	2400	3400	K497/K493	0.44	1.35	0.74	29	1.60
		152.4	6	39.688	1.5625	36.322	1.43	30.162	1.1875	3.175	3.5	315	167	2000	3400	K596/K592A	0.44	1.36	0.75	39	2.92
		133.35	5.25	30.162	1.1875	29.769	1.172	22.225	0.875	3.3	3.556	134	198	2200	3200	K497/K492A	0.44	1.35	0.74	23	1.47
		142.138	5.596	42.862	1.6875	42.862	1.6875	34.133	1.3438	3	4.8	220	345	2200	3200	KHM617049/KHM617010	0.43	1.4	0.76	35	2.63
		146.05	5.75	41.275	1.625	41.275	1.625	31.75	1.25	3.175	6.4	217	315	2200	3200	K665A/K653	0.41	1.47	0.81	33	2.74
88.9	3.5	118.618	4.67	39.688	1.5625	39.688	1.5625	30.162	1.1875	3.556	6.35	286	350	2000	3000	KHM518445/KHM518410	0.4	1.49	0.82	33	2.86
		152.4	6	39.688	1.5625	36.322	1.43	30.162	1.1875	3.175	6.4	184	286	1800	2700	K593A/K592A	0.44	1.36	0.75	39	2.80
		152.4	6	39.688	1.5625	39.688	1.5625	30.162	1.1875	3.3	6.4	255	370	1800	2700	KHM518445/KHM518410	0.4	1.49	0.82	34	2.70
		161.925	6.375	53.975	2.125	55.1	2.1693	42.862	1.6875	3.3	3.5	315	475	2400	3400	K6580/K6535	0.4	1.49	0.82	41	4.73
		168.275	6.625	41.275	1.625	41.275	1.625	30.162	1.1875	3.3	3.5	205	350	1800	2700	K679/K672	0.47	1.28	0.7	38	4.03
		190.5	7.5	57.15	2.25	57.531	2.265	44.45	1.75	3.3	8	380	555	1900	2600	K855/K854	0.33	1.8	0.99	42	7.69
		190.5	7.5	57.15	2.265	57.531	2.265	46.038	1.8125	3.3	8	445	610	1700	2400	KHH221434/KHH221410	0.33	1.79	0.99	24	7.87

# Inch Single Row Tapered Roller Bearings

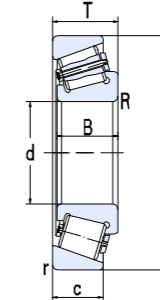
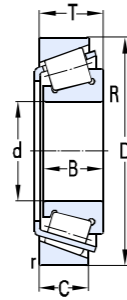

Basic dimensions											Basic load ratings		Limit speed		Designations	Calculation factor				Weight	
d		D		T		B		C		rmin	Rmin	Cr	Cor	Grease		Oil	e	Y	Yo		a
mm	in	mm	in	mm	in	mm	in	mm	in	mm	mm	KN		r/min							Kg
90*		145*		35		34		27		2.5	6	189	315	2200	3200	KJM718149A/KJM718110	0.44	1.36	0.75	33	2.17
		147*		40		40		32.5		3.5	7	216	345	2200	3200	KHM218248/KHM218210	0.33	1.8	0.99	31	2.51
92.075	3.625	150	9.9055	35.992	1.417	36.322	1.43	27	1.063	3	6.35	184	286	1900	2800	598A/593X	0.44	1.36	0.75	34	2.37
		152.4	6	39.688	1.5625	36.322	1.43	30.162	1.1875	3.302	6.35	232	315	1900	2800	598A/592A	0.44	1.36	0.75	34	2.67
		180.975	7.125	47.625	1.875	48.006	1.89	38.1	1.5	3.3	3.5	288	435	1900	2800	K778/K772	0.39	1.56	0.86	44	5.55
95*		150*		35		34		27		2.5	3	187	290	1900	2800	KJM719149/KJM719113	0.44	1.4	0.75	33	2.23
95.25	3.75	147.638	5.8125	35.717	1.4062	36.322	1.43	26.192	1.0312	0.8	5	228	310	1900	2800	594A/592XE	0.44	1.39	0.75	34	2.13
		152.4	6	39.688	1.5625	36.322	1.43	30.162	1.1875	3.302	5.08	228	310	1900	2800	594A/592A	0.44	1.36	0.75	34	2.54
		168.275	6.625	41.275	1.625	41.275	1.625	30.162	1.1875	3.3	3.5	222	350	1900	2800	K683/K672	0.48	1.25	0.7	38	3.75
96.838	3.8125	148.43	5.8437	28.575	1.125	28.971	1.1406	21.433	0.8438	3	3.5	146	230	1900	2800	K42381/K42584	0.49	1.22	0.67	32	1.68
		188.912	7.4375	50.8	2	46.038	1.8125	31.75	1.25	3.3	3.5	270	345	1900	2800	K90381/K90744	0.87	0.69	0.38	62	5.63
99.974		156.975		42		42		34		3.5	8	253	400	1900	2800	KHM220149/KHM220110	0.33	1.84	1.01	42	2.89
99.975	3.936	212.725	8.375	66.675	2.625	66.675	2.625	53.975	2.125	3.3	3.5	600	830	1900	2800	KHH224334/KHH224310	0.33	1.84	1.01	54	11.2
100*		145*		24		22.5		17.5		5	3	116	171	1900	2800	KJP10049A/KJP10010	0.47	1.27	0.7	30	1.13
		155*		36		35		28		2.5	3	231	260	1900	2800	KJM720249/KJM720210	0.47	1.27	0.7	36	2.34
		157*		42		42		34		SP	SP	253	400	1900	2800	KHM220149A6/KHM220110A6	0.33	1.8	0.99	33	2.89
101.6	4	157.162	6.1875	36.512	1.4375	36.116	1.4219	26.195	1.0313	3.3	3.5	193	315	2000	2800	K52400/K52618	0.47	1.3	0.69	36	2.48
		168.275	6.625	41.275	1.625	41.275	1.625	30.162	1.1875	3.3	3.5	221	350	2000	2800	K687/K672	0.47	1.28	0.7	38	3.43
		180.975	7.125	47.625	1.875	48.006	1.89	38.1	1.5	3.3	3.5	290	435	2000	2600	K780/K772	0.39	1.6	0.83	39	5.00
		190.5	7.5	57.15	2.25	57.531	2.265	44.45	1.75	3.3	8	380	555	1900	2600	K861/K854	0.33	1.8	0.99	42	6.80
		190.5	7.5	57.15	2.25	57.531	2.265	46.038	1.8125	3.3	8	445	610	1800	2600	KHH221449/KHH221410	0.33	1.79	0.99	24	7.87
		212.725	8.375	66.675	2.625	66.675	2.625	53.975	2.125	3.3	7	655	900	1800	2600	KHH224335/KHH224310	0.33	1.84	1.01	48	11.1
		212.725	8.375	66.675	2.625	66.675	2.265	53.975	2.125	3.3	7	450	675	1800	2600	K941/K932	0.33	1.84	1.01	48	11.0
		212.725	8.375	66.675	2.625	66.675	2.265	53.975	2.125	3.3	7	585	840	1700	2200	KHH224335/KHH224310	0.33	1.84	1.01	47	11.1
		214.312	8.437	55.562	2.187	52.388	2.063	39.688	1.563	3.5	3.3	375	590	1550	2100	KH924033/KH924010	0.674	0.89	0.49		9.15
		250.825	9.875	76.2	3	73.025	2.875	50.8	2	6.4	6.4	550	695	1400	1900	KHH923649/KHH923610	0.71	0.85	0.47	85	17.6
104.775	4.125	180.975	7.125	47.625	1.875	48.006	1.89	38.1	1.5	3.3	7	288	435	2000	2600	K787/K772	0.39	1.6	0.86	39	4.78
		180.975	7.125	47.625	1.875	48.006	1.89	38.1	1.5	3.3	3.5	288	435	2000	2600	K782/K772	0.39	1.56	0.86	39	4.81

# Inch Single Row Tapered Roller Bearings

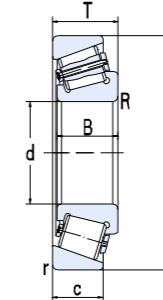
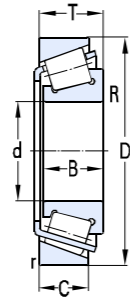

Basic dimensions												Basic load ratings		Limit speed		Designations	Calculation factor				Weight
d		D		T		B		C		rmin	Rmin	Cr	Cor	Grease	Oil		e	Y	Yo	a	
mm	in	mm	in	mm	in	mm	in	mm	in	mm		KN		r/min							Kg
		180.975	7.125	47.625	1.875	48.006	1.89	38.1	1.5	3.3	6.4	288	435	2000	2600	K786/K772	0.39	1.56	0.86	39	4.79
107.95	4.25	146.05	5.75	21.433	0.8438	21.433	0.8438	16.67	0.6563	1.5	1.5	106	180	1900	2800	KL521949/KL521910	0.39	1.54	0.85	26	0.993
		158.75	6.25	23.02	0.9063	21.438	0.844	15.875	0.625	3.3	3.5	107	174	1900	2800	K37425/K37625	0.61	0.99	0.54	39	1.36
		165.1	6.5	36.512	1.4375	36.512	1.4375	26.988	1.0625	3.3	3.5	198	330	1900	2800	K56425/K56650	0.5	1.2	0.7	38	2.67
109.538	4.3125	158.75	6.25	23.02	0.9063	21.438	0.844	15.875	0.625	3.3	5	107	174	1900	2800	K37431A/K37625	0.61	0.99	0.54	39	1.32
110*	4.3307	165*		35		35		26.5		2.5	3	195	320	1900	2800	KJM822049/KJM822010	0.5	1.21	0.66	39	2.63
		180*		47		46		38		2.5	3	320	510	1900	2800	JHM522649/JHM522610	0.41	1.48	0.81	40	4.56
		165*		35		35		26.5		3	2.5	211	360	1900	2800	KM822049/KM822010	0.5	1.2	0.66	38	2.63
		180*		47		46		38		2.5	3	320	510	1900	2800	KJHM522649/KJHM522610	0.41	1.48	0.81	40	4.56
		180	7.0866	47	1.8504	46	1.811	38	1.496	2.5	3	320	510	1900	2800	KRJHM522649/JHM522610	0.41	1.48	0.81	40	4.56
114.3	4.5	177.8	7	41.275	1.625	41.275	1.625	30.162	1.1875	3.3	3.5	250	400	1900	2800	K64450/K64700	0.52	1.23	0.64	43	3.50
		190.5	7.5	47.625	1.875	49.212	1.9375	34.925	1.375	3.3	3.5	305	480	1900	2800	K71450/K71750	0.41	1.48	0.81	41	5.26
		212.725	8.375	66.675	2.625	66.675	2.625	53.957	2.1243	3.3	7	450	675	1700	2400	K938/K932	0.33	1.8	1	47	9.95
		228.6	9	53.975	2.125	49.428	1.946	38.1	1.5	3.3	3.5	400	590	1700	2400	KHM926740/KHM926710	0.74	0.81	0.45	69	9.78
114.976	4.5266	180.975	7.125	41.275	1.625	41.275	1.625	30.162	1.1875	3.3	9	250	400	1900	2800	K64452A/K64713	0.52	1.15	0.63	43	3.72
117.8	4.6378	247.65	9.75	47.625	1.875	47.625	1.875	38.1	1.5	3.3	10.5	420	520	1600	2300	K67791/K67720	0.44	1.36	0.75	52	6.82
120*		170*		27		25		19.5		3	3	155	243	1900	2800	KJP12049/KJP12010	0.47	1.3	0.69	35	1.75
120.65	4.75	206.375	8.125	47.625	1.875	47.625	1.875	34.925	1.375	3.3	3.3	330	550	1600	2200	K795/K792	0.46	1.3	0.72	46	6.28
		273.05	10.75	82.55	3.25	82.55	3.25	53.975	2.125	6.4	6.4	815	940	1700	2400	HH926749/HH926710	0.63	0.95	0.52	76	22.1
		182.562	7.1875	39.688	1.5625	38.1	1.5	33.338	1.3125	3.3	3.5	228	430	1700	2400	K48282/K48220	0.3	2	1.1	34	3.56
		254	10	77.78	3.0622	82.55	3.25	61.912	2.4375	6.4	9.7	730	1060	1500	2000	KHH228340/KHH228310-3	0.32	1.9	1	31	18.2
127	5	182.562	7.1875	39.688	1.5625	38.1	1.5	33.338	1.3125	3.3	3.5	228	430	1700	2400	K48290/K48220	0.3	2	1.1	34	3.20
		182.562	7.1875	39.688	1.5625	38.1	1.5	33.338	1.3125	3.3	3.5	240	430	1700	2400	48290/48220	0.3	2	1.1	34	3.20
		234.95	9.25	63.5	2.5	63.5	2.5	49.212	1.9375	3.3	6.4	515	810	1700	2400	K95500/K95925	0.37	1.62	0.89	51	11.6
		228.6	9	53.975	2.125	49.428	1.946	38.1	1.5	3.3	3.5	400	590	1700	2400	KHM926747/KHM926710	0.74	0.81	0.45	68	8.88
128.588	5.0625	206.375	8.125	47.625	1.875	47.625	1.875	34.925	1.375	3.3	3.3	330	550	1600	2200	K799/K792	0.46	1.3	0.72	46	5.70



# Inch Single Row Tapered Roller Bearings

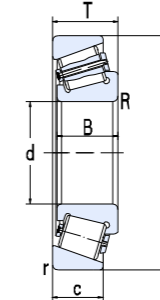
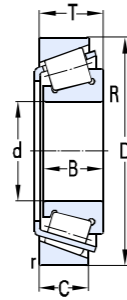

Basic dimensions												Basic load ratings		Limit speed		Designations	Calculation factor				Weight
d		D		T		B		C		rmin	Rmin	Cr	Cor	Grease	Oil		e	Y	Yo	a	
mm	in	mm	in	mm	in	mm	in	mm	in	mm		KN		r/min							Kg
130.175	5.125	196.85	7.75	46.038	1.8125	46.038	1.8125	38.1	1.5	3.3	3.5	330	590	1600	2200	67389/67322	0.34	1.74	0.96	40	4.96
133.35	5.25	196.85	7.75	46.038	1.8125	46.038	1.8125	38.1	1.5	3.3	3.5	380	420	1600	2200	K67390/K67322	0.34	1.74	0.96	40	4.71
		234.95	9.25	63.5	2.5	63.5	2.5	49.212	1.9375	3.3	9.7	515	810	1500	2000	95525/95925	0.37	1.62	0.89	51	11.1
		234.95	9.25	63.5	2.5	63.5	2.5	49.212	1.9375	3.3	9.7	515	810	1500	2000	K95525/K95925	0.37	1.62	0.89	51	11.1
139.7	5.5	228.6	9	57.15	2.25	57.15	2.25	44.45	1.75	3.3	3.5	370	680	1400	1900	K898/K892	0.42	1.43	0.79	50	8.85
		236.538	9.3125	57.15	2.25	56.642	2.23	44.45	1.75	3.3	3.5	510	810	1400	1900	KHM231132/KHM231110	0.31	1.9	1.1	45	10.1
		254	10	66.675	2.625	66.675	2.625	47.625	1.875	3.3	7	715	1100	1400	1900	K99550/K99100	0.41	1.47	0.81	54	14.0
146.05	5.75	193.675	7.625	28.575	1.125	28.575	1.125	23.02	0.9063	1.5	1.5	186	370	1600	2200	K36690/K36620B	0.37	1.6	0.9	34	2.22
		236.538	9.25	57.15	2.25	56.642	2.23	44.45	1.75	3.3	3.5	406	700	1300	1900	K82576/K82931	0.44	1.36	0.75	52	9.56
		304.8	12	88.9	3.5	82.55	3.25	57.15	2.25	6.4	6.4	835	1140	1100	1600	KHH932145/KHH932110	0.73	0.82	0.45	105	28.3
152.4	6	222.25	8.75	46.83	1.8437	46.83	1.8437	34.925	1.375	1.5	3.5	314	540	1100	1600	KM231649/KM231610	0.33	1.8	0.99	28	5.76
		254	10	66.675	2.625	66.675	2.625	47.625	1.875	3.3	7	595	930	1100	1600	K99600/K99100	0.41	1.5	0.81	55	12.5
		268.288	10.563	74.612	2.9375	74.612	2.9375	57.15	2.25	6.4	6.4	670	1070	1200	1700	KEE107060/K107105	0.39	1.55	0.85	58	16.8
		307.975	12.125	88.9	3.5	93.662	3.6875	66.675	2.625	6.8	9.7	1190	1350	1100	1600	KHH234048/KHH234010	0.33	1.84	1.01	63	30.9
158.75	6.25	225.425	8.875	41.275	1.625	39.688	1.5625	33.338	1.3125	3.3	3.5	261	440	1100	1600	K46780/K46720	0.38	1.57	0.86	44	5.24
165.1	6.5	225.425	8.875	41.275	1.625	39.688	1.5625	33.338	1.3125	3.3	3.5	261	565	1100	1600	K46790/K46720	0.38	1.57	0.86	44	4.64
		247.65	9.75	47.625	1.875	47.625	1.875	38.1	1.5	3.3	3.5	415	520	1000	1400	K67780/K67720	0.44	1.36	0.75	52	8.16
		288.925	11.375	63.5	2.5	63.5	2.5	47.625	1.875	7	3.3	625	670	1100	1600	KHM237535/KHM237510	0.32	1.88	1.04	52	16.8
		336.55	13.25	92.075	3.625	95.25	3.75	69.85	2.75	6.4	3.3	1320	1500	900	1300	KHH437549/KHH437510	0.37	1.6	0.88	72	37.4
170*		230*		39		38		31		2.5	3	289	550	1100	1600	KJHM534149/KJHM534110	0.38	1.57	0.86	44	4.45
		240*		46		44.5		37		2.5	3	355	675	1000	1400	KJM734449/KJM734410	0.44	1.37	0.75	52	6.28
171.45	6.75	260.35	10.25	66.675	2.625	66.675	2.625	52.388	2.0625	3.3	3.5	550	1070	1000	1400	KHM535349/KHM535310	0.4	1.6	0.83	64	12.3
174.625	6.875	288.925	11.375	63.5	2.5	63.5	2.5	47.625	1.875	3.3	7	815	850	1000	1400	KHM237542/KHM237510	0.33	1.84	1.01	54	16.9
		288.925	11.375	63.5	2.5	63.5	2.5	47.625	1.875	3.3	7	815	850	1000	1400	KHM237545/KHM237510	0.33	1.84	1.01	54	16.9
177.8	7	247.65	9.75	47.625	1.875	47.625	1.875	38.1	1.5	3.3	3.5	415	520	1000	1400	K67790/K67720	0.44	1.36	0.75	52	7.12
		260.35	10.25	53.975	2.125	53.975	2.125	41.275	1.625	3.3	3.5	430	840	1000	1400	KM236849/KM236810	0.33	1.8	0.99	47	9.08
		288.925	11.375	63.5	2.5	63.5	2.5	47.625	1.875	3.3	7	815	850	900	1300	KHM237545/KHM237510	0.33	1.84	1.01	54	16.7

# Inch Single Row Tapered Roller Bearings

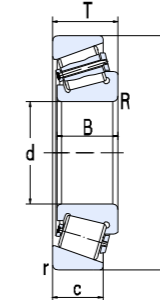
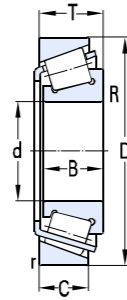

Basic dimensions												Basic load ratings		Limit speed		Designations	Calculation factor				Weight
d		D		T		B		C		rmin	Rmin	Cr	Cor	Grease	Oil		e	Y	Yo	a	
mm	in	mm	in	mm	in	mm	in	mm	in	mm		KN		r/min							Kg
		319.964 428.628	12.597 16.8751	88.9 106.362	3.5 4.1875	85.725 95.25	3.375 3.75	65.088 61.912	2.5625 2.4375	4.8 6.4	3.5 6.4	930 1320	1420 1840	1000 900	1400 1000	KH239640/KH239610 KEE350701/K351687	0.32 0.76	1.88 0.82	1.04 0.43	65 121	28.2 68.1
178.595	7.0313	265.112	10.4375	51.595	2.0313	57.15	2.25	38.895	1.5313	3.3	3.3	485	870	1000	1400	M336948/M336912	0.33	1.8	1	47	9.75
179.934	7.084	265.112	10.4375	51.595	2.0313	57.15	2.25	38.895	1.5313	3.3	3.3	485	870	1000	1400	M336949/M336912	0.33	1.8	1	47	9.55
180*	7.0866	250*		47		45		37		3	2.5	400	780	900	1000	JM736149/JM736110	0.48	1.25	0.69	56	6.80
184.15	7.25	266.7 280	10.5 11.0236	47.625 46.525	1.875 1.8317	46.833 46.833	1.8438 1.8438	38.1 36	1.5 1.4173	3.3 3.3	3.5 3.5	485 360	520 760	900 900	1000 1000	K67883CL4/K67820CL4 K67883/K67830	0.33 0.48	1.81 1.26	1 0.69	46 58	8.34 10.1
187.325	7.375	269.875 282.575 320.675	10.625 11.125 12.625	55.562 50.8 88.9	2.1875 2 3.5	55.562 47.625 85.725	2.1875 1.875 3.375	42.862 36.512 65.088	1.6875 1.4375 2.5625	3.3 3.3 4.8	3.5 3.5 5.5	425 395 930	860 690 1420	900 900 800	1000 1000 900	KM238849/KM238810 87737/87111 KH239649/KH239612	0.33 0.43 0.32	1.81 1.4 2.11	1 0.8 2.06	49 55 56	9.63 9.95 26.7
190.475	7.499	279.4	11	52.388	2.0625	57.15	2.25	41.275	1.625	3.3	3.3	515	985	900	1000	M239449/M239410	0.35	1.7	0.9	49	9.80
190.5	7.5	266.7 365.049	10.5 14.372	47.625 92.075	1.875 3.625	46.833 88.897	1.8438 3.4999	38.1 63.5	1.5 2.5	3.3 3.3	3.5 6.4	345 990	725 1460	1100 900	1500 1000	K67885/K67820 KEE420751/K421437	0.48 0.4	1.3 1.6	0.69 0.83	58 79	8.04 39.3
191.237	7.529	279.4	11	52.388	2.0625	58.738	2.3125	41.275	1.625	3.3	3.3	515	985	900	1000	M239448A/M239410	0.35	1.7	0.9	49	9.55
196.85	7.75	241.3 257.175 266.7 317.5	9.5 10.125 10.125 12.5	23.812 39.688 39.688 63.5	0.9375 1.5625 1.5625 2.5	23.017 39.688 39.688 63.5	0.9062 1.5625 1.5625 2.5	17.462 30.162 30.162 46.038	0.6875 1.1875 1.1875 1.8125	1.5 3.3 3.3 3.3	1.5 3.5 3.5 4.3	160 275 275 605	330 635 635 1130	1200 1100 1100 850	1700 1600 1600 1200	KLL639249/KLL639210 KLM739749/KLM739710 KLM739749/KLM739719 K93775/K93125	0.43 0.44 0.44 0.52	1.4 1.35 1.35 1.15	0.8 0.8 0.8 0.63	41 50 50 73	2.10 5.20 6.14 18.8
200*		300*		65		62		51		2.5	3.5	615	1240	850	1200	JHM840449/JHM840410	0.52	1.15	0.63	72	15.5
200.025	7.875	276.225	10.875	42.862	1.6875	46.038	1.8125	34.133	1.3438	3.3	3.5	445	780	1000	1500	LM241147/LM241100	0.31	1.9	1.1	45	7.75
203.987	8.031	276.225	10.875	42.862	1.6875	46.038	1.8125	34.133	1.3438	3.3	3.5	445	780	1000	1500	LM241148/LM241100	0.31	1.9	1.1	45	7.35
206.375	8.125	282.575 336.55	11.125 13.25	46.038 98.425	1.8125 3.875	46.038 100.012	1.8125 3.9375	36.512 77.788	1.4375 3.0625	3.3 3.3	3.5 3.3	375 965	840 1400	1000 850	1500 1200	67985/67920 KH242649/KH242610	0.5 0.34	1.2 1.78	0.7 0.98	62 52	8.70 33.0

# Inch Single Row Tapered Roller Bearings

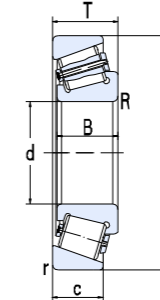
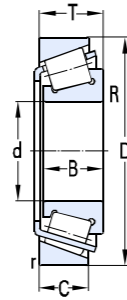

Basic dimensions												Basic load ratings		Limit speed		Designations	Calculation factor				Weight
d		D		T		B		C		rmin	Rmin	Cr	Cor	Grease	Oil		e	Y	Yo	a	
mm	in	mm	in	mm	in	mm	in	mm	in	mm		KN		r/min							Kg
209.55	8.25	317.5	12.5	63.5	2.5	63.5	2.5	46.038	1.8125	3.3	4.3	605	1130	850	1200	93825/93125	0.52	1.15	0.63	73	16.6
215.9	8.5	285.75	11.25	46.038	1.8125	46.038	1.8125	34.924	1.375	3.3	3.5	375	840	1000	1500	LM742749/LM742710	0.48	1.25	0.7	60	8.00
216.408	8.52	285.75	11.25	46.038	1.8125	46.038	1.8125	34.924	1.375	3.3	3.5	375	840	1000	1500	LM742747/LM742710	0.48	1.25	0.7	60	7.95
216.713	8.532	285.75	11.25	46.038	1.8125	46.038	1.8125	34.924	1.375	3.3	3.5	375	840	1000	1500	LM742747A/LM742710	0.48	1.25	0.7	60	7.95
220.662	8.6875	314.325	12.375	61.912	2.4375	61.912	2.4375	49.212	1.9375	3.3	6.4	620	1220	1000	1500	KM244249/KM244210	0.33	1.88	0.99	58	14.9
228.397		431.8		92.075		85.725		49.212		6.4	6.4	1080	1600	850	1150	KEE113089/K113170	0.88	0.77	0.75	116	51.9
228.6	9	358.775 488.95	14.125 19.25	71.438 123.825	2.8125 4.875	71.438 111.125	2.8125 4.375	53.975 73.025	2.125 2.875	3.3 6.4	3.5 6.4	750 1820	1500 2490	950 750	1300 1000	KM249732/KM249710-1 HH949549/HH949510	0.33 0.94	1.8 0.64	0.99 0.35	65 174	27.2 101
230.188	9.0625	317.5	12.5	47.625	1.875	52.388	2.0625	36.512	1.4375	3.3	3.3	520	985	900	1200	LM245846/LM245810	0.31	1.9	1.1	49	10.6
231.775	9.125	300.038 317.5 336.55	11.8125 12.5 13.25	33.338 47.625 65.088	1.3125 1.875 2.5625	31.750 52.388 65.088	1.25 2.0625 2.5625	23.812 36.512 50.8	0.9375 1.4375 2	3.3 3.3 3.3	3.3 3.3 6.4	212 520 640	420 985 1360	950 900 850	1300 1200 1200	544091/544118A LM245848/LM245810 KM246942/KM246910	0.4 0.31 0.33	1.5 1.9 1.8	0.8 1.1 0.99	49 49 61	5.40 10.6 18.5
234.95	9.25	384.175	15.125	112.712	4.4375	112.712	4.4375	90.488	3.5625	6.4	6.4	1360	2540	750	1000	KH247549/KH247510	0.33	1.88	0.99	84	50.0
237.33	9.3437	336.55	13.25	65.088	2.5625	65.088	2.5625	50.8	2	3.3	6.4	640	1360	850	1200	KM246949/KM246910	0.33	1.8	0.99	61	17.5
241.3	9.5	444.5 327.025 508	17.5 12.875 20	101.6 52.388 117.475	4 2.063 4.625	100.012 52.388 95.25	3.9375 2.063 3.75	76.2 36.512 73.025	3 1.437480315 2.875	4.8 3.3 6.4	6.4 6.4 6.4	1340 470 1340	2000 950 2060	750 900 900	1000 1200 900	KEE923095/K923175 K8578/K8520 KEE390095/K390200	0.34 0.41 0.94	1.78 1.5 0.64	0.98 0.81 0.35	83 60 132	65.9 11.3 96.4
247.65	9.75	346.075 406.4 358.775	13.625 16 14.125	63.5 115.888 71.438	2.5 4.5625 2.8125	63.5 117.475 76.2	2.5 4.625 3	50.8 93.662 53.975	2 3.6875 2.125	6.4 6.4 3.3	6.4 6.4 1.5	670 1690 740	1310 3200 1450	850 750 800	1200 1000 1100	KM348449/KM348410 HH249949/HH249910 M249749/M249710B/YAB	0.34 0.33 0.33	1.75 1.8 1.8	0.96 0.99 0.99	61 87 75	17.4 58.0 23.6
254*	10	324.975* 324.975* 533.4	12.7943 12.7943 21	39 39 133.35		41.5 41.5 120.65		28 28 77.788		3.3 3.3 6.4	1.5 1.5 6.4	345 365 365	800 800 800	850 850 850	1200 1200 1200	1-7009 L848849SH/L848810SH HH953749/HH953710	0.56 0.56 0.94	1.07 1.07 0.64	0.59 0.59 0.35	71 71 179	8.06 8.06 129

# Inch Single Row Tapered Roller Bearings

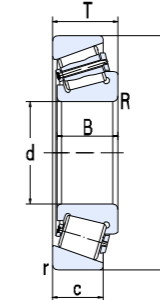
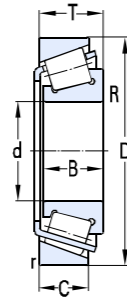

Basic dimensions												Basic load ratings		Limit speed		Designations	Calculation factor				Weight
d		D		T		B		C		rmin	Rmin	Cr	Cor	Grease	Oil		e	Y	Yo	a	
mm	in	mm	in	mm	in	mm	in	mm	in	mm		KN		r/min							Kg
255.6	10.063	342.9	13.5	57.15	2.25	63.5	2.5	44.45	1.75	3.3	1.5	665	1330	850	1200	M349547SH/M349510SH	0.35	1.73	0.95	59	14.4
		342.9	13.5	57.15	2.25	63.5	2.5	44.45	1.75	3.3	1.5	564	1170	850	1200	KM349547/KM349510	0.35	1.73	0.95	59	16.1
257.175	10.125	342.9	13.5	57.15	2.25	57.15	2.25	44.45	1.75	3.3	6.4	725	880	850	1200	KM349549/KM349510	0.35	1.73	0.95	80	14.0
		358.775	14.125	71.438	2.8125	76.2	3	53.975	2.125	3.3	1.5	770	1570	850	1200	KM249747/KM249710	0.33	1.8	0.99	64	21.7
260.35	10.25	422.275	16.625	86.121	3.3906	79.771	3.1406	66.675	2.625	3.3	6.8	1100	1800	900	1300	HM252348/HM252310	0.33	1.8	0.99	78	42.8
263.525	10.375	325.438	12.8125	28.575	1.125	28.575	1.125	25.400	1	1.5	1.5	1280	1790	1000	1500	38880/38820	0.37	1.6	0.9	49	54.2
266.7	10.5	355.6	14	57.15	2.25	57.15	2.25	44.45	1.75	3.3	3.5	715	800	850	1200	KLM451349/KLM451310	0.36	1.67	0.92	62	15.1
		393.7	15.5	73.817	5.125	69.85	2.75	50.005	1.9687	6.4	6.4	770	1460	750	1000	KEE275105/K275155	0.4	1.49	0.82	75	27.8
		444.5	17.5	120.65	4.75	117.475	4.625	88.9	3.5	6.4	6.4	1610	3050	670	900	KH852849/KH852810	0.58	1.04	0.57	121	73.1
273.05	10.75	393.7	15.5	73.817	5.125	69.85	2.75	50.005	1.9687	6.4	6.4	770	1460	750	1000	KEE275108/K275155	0.4	1.49	0.82	75	26.3
288.925	11.375	406.4	16	77.788	3.0625	77.788	3.0625	60.325	2.375	3.3	6.4	1250	1900	670	900	M255449/M255410	0.34	1.78	0.98	72	30.5
292.100	11.5	374.650	14.75	47.625	1.875	47.625	1.875	34.925	1.375	3.3	3.5	1080	1590	780	1050	L555249/L555210	0.4	1.5	0.8	65	12.2
304.8	12	393.7	15.5	50.8	2	50.8	2	38.1	1.5	3.3	6.4	580	1210	670	900	KL357049/KL357010	0.36	1.68	0.92	64	14.6
		406.4	16	63.5	2.5	63.5	2.5	47.625	1.875	3.3	6.4	2200	2800	670	900	LM757049/LM757010	0.44	1.38	0.76	79	21.2
317.5	12.5	447.675	17.625	85.725	3.375	85.725	3.375	68.262	2.6875	3.3	3.5	960	2330	670	900	HM259048/HM259010	0.33	1.8	0.99	80	41.3
330.2	13	415.925	16.375	47.625	1.875	47.625	1.875	34.925	1.375	3.3	3.5	475	1140	670	900	KL860049/KL860010	0.5	1.2	0.7	83	14.3
		482.600	19	85.725	3.375	80.167	3.1562	60.325	2.375	3.5	6.4	1200	2480	600	830	EE526130/526190	0.4	1.5	0.8	90	49.2
333.375	13.125	469.900	18.5	90.488	3.5625	90.488	3.5625	71.438	2.8125	3.3	6.4	1320	2820	600	830	HM261049/HM261010	0.33	1.8	1	85	47.6
342.9	13.5	450.85	17.75	66.673	2.625	66.675	2.625	52.388	2.0625	3.5	8.5	770	1750	630	850	KLM361649/KLM361610	0.33	1.8	1	78	26.5
343.154	13.51	450.850	17.75	66.675	2.625	66.675	2.625	52.388	2.0625	3.5	8.5	930	2180	650	850	LM361649A/LM361610	0.35	1.7	0.9	75	28.3
346.075	13.625	488.950	19.25	95.250	3.75	95.250	3.75	74.612	2.9375	3.3	6.4	1350	2900	600	830	HM262749/HM262710	0.33	1.8	1	88	55.8
371.5	14.626	622.3	24.5	147.638	5.8125	131.762	5.1875	82.55	3.25	12.7	14.3	2300	3600	420	580	H961649/H961610	0.94	0.64	0.35	210	180

# Inch Single Row Tapered Roller Bearings

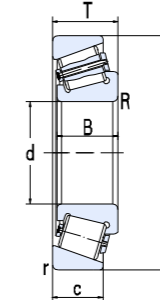
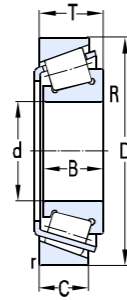

Basic dimensions												Basic load ratings		Limit speed		Designations	Calculation factor				Weight
d		D		T		B		C		rmin	Rmin	Cr	Cor	Grease	Oil		e	Y	Yo	a	
mm	in	mm	in	mm	in	mm	in	mm	in	mm		KN		r/min							Kg
377.825	14.875	522.288	20.5625	85.725	3.375	84.138	3.3125	61.912	2.4375	3.3	6.4	1170	2580	670	900	KLM565946/KLM565910	0.38	1.56	0.86	93	51.9
380.1	14.9646	480	18.8976	50	1.9685	48.08	1.8929	35.08	1.3811	4	6	590	1490	560	750	306/380.1	0.5	1.2	0.7	93	20.8
381	15	479.425	18.875	49.212	1.9375	47.625	1.875	34.925	1.375	3.3	6.4	590	1490	560	750	L865547/L865512	0.5	1.2	0.7	92	20.4
		522.288	20.5625	85.725	3.375	84.138	3.3125	61.912	2.4375	3.3	6.4	1170	2580	650	870	KLM565949/KLM565910	0.38	1.56	0.86	93	51.2
		546.1	21.5	104.775	5.5423	104.775	5.5423	82.55	3.25	6.4	6.4	1860	4100	560	750	KHM266446/KHM266410	0.33	1.8	1	96	77.7
384.175	15.125	546.100	21.5	104.775	4.125	104.775	4.125	82.550	3.25	6.4	6.4	1850	4150	530	700	HM266449/HM266410	0.33	1.8	1	96	77.6
403.225	15.875	460.375	18.125	28.575	1.125	28.575	1.125	20.638	0.8125	3.3	3.5	240	760	560	750	LL566848/LL566810	0.4	1.5	0.8	70	6.73
406.4	16	546.1	21.5	76.2	3	61.12	2.4063	55.562	2.1875	6.4	6.4	840	1830	630	850	KEE234160/K234215	0.48	1.26	0.69	107	41.8
		549.275	21.625	85.725	3.375	84.138	3.3125	61.962	2.4394	3.3	6.4	1350	3000	600	800	LM567949/LM567910	0.4	1.5	0.8	100	54.0
		574.625	22.623	76.2	3	67.866	2.6719	50.8	2	3.3	6.8	920	2030	500	650	EE285160/EE285226	0.5	1.2	0.7	114	54.2
		762	30	180.975	7.125	161.925	6.375	107.950	4.25	12.7	12.7	3650	6050	350	480	H969249/H969210	0.94	0.64	0.35	250	322
415.925	16.375	590.55	23.25	114.3	4.5	114.3	4.5	88.9	3.5	6.4	6.4	1810	4030	480	650	M268749/M268710	0.33	1.8	0.99	104	96.6
430.212	16.9375	603.250	23.75	76.2	3	73.025	2.875	50.8	2	6.4	6.4	1050	2300	480	650	EE241693/242375	0.52	1.15	0.6	122	58.6
447.625	17.623	635	25	120.650	4.75	120.650	4.75	95.250	3.75	6.4	6.4	2300	5450	430	560	M270749/M270710	0.33	1.8	1	111	121
457.2	18	573.088	22.5625	74.612	2.9375	74.612	2.9375	57.150	2.25	6.4	6.4	1100	2980	480	630	L570649/L570610	0.4	1.5	0.8	101	43.8
		596.9		76.2		73.025		53.975		3.3	9.7	1200	2500	450	600	KEE244180/K244235	0.4	1.5	0.8	102	50.8
		603.250	23.75	85.725	3.375	84.138	3.3125	60.325	2.375	3.3	6.4	1420	3390	450	600	LM770949/LM770910	0.46	1.3	0.7	115	62.0
		615.950	24.25	85.725	3.375	85.725	3.375	66.675	2.625	6.4	6.4	1450	3750	420	580	LM272235/LM272210	0.33	1.8	1	98	73.2
		660.400	26	91.280	3.5937	85.725	3.375	62.705	2.4687	6.4	10.5	1750	3600	420	580	EE737181/737260	0.37	1.6	0.9	107	91.5
482.6	19	634.873	24.995	80.962	3.1875	80.962	3.1875	63.5	2.5	3.3	6.4	1430	3600	420	580	EE243190/243250	0.35	1.7	0.9	98	60.8
488.95	19.25	634.873	24.995	84.138	3.3125	84.138	3.3125	61.912	2.4375	3.3	6.4	1420	3600	420	580	LM772748/LM772710	0.48	1.25	0.7	124	64.5
498.475	19.625	634.873	24.995	80.962	3.1875	80.962	3.1875	63.5	2.5	3.3	6.4	1400	3500	420	580	EE243196/243250/HE	0.35	1.7	0.9	98	58.3
501.65		711.2		136.525		136.525		106.363		6.4	6.4	2760	6110	400	530	M274149/M274110	0.35	1.7	0.9	102	163

# Inch Single Row Tapered Roller Bearings

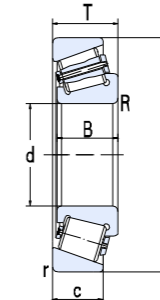
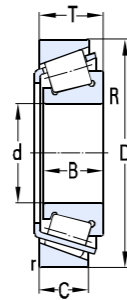

Basic dimensions												Basic load ratings		Limit speed		Designations	Calculation factor				Weight
d		D		T		B		C		rmin	Rmin	Cr	Cor	Grease	Oil		e	Y	Yo	a	
mm	in	mm	in	mm	in	mm	in	mm	in	mm		KN		r/min							Kg
520.7	20.5	736.6	29	88.9	3.5	81.758	3.2188	53.975	2.125	3.3	6.4	1630	3350	380	500	EE982051/982900	0.48	1.25	0.7	134	101
536.575	21.125	761.873 820	29.995 32.2835	146.05 152	5.75 5.9843	146.05 146	5.75 5.748	114.3 112	4.5 4.4094	6.4 5	6.4 6	3300 3850	7950 7750	360 340	480 450	M276449/M276410 306/536X4	0.33 0.43	1.8 1.4	1 0.8	134 161	202 273
549.275	21.625	692.15	27.25	80.962	3.1875	80.962	3.1875	61.912	2.437	6.4	6.4	1350	3470	560	750	KL476549/KL476510	0.37	1.6	0.9	113	69.0
539.750	21.25	635	25	50.8	2	50.8	2	38.1	1.5	6.4	6.4	780	2150	400	530	LL575349/LL575310	0.4	1.5	0.8	102	27.2
607.72	23.926	787.4	31	93.662	3.6875	93.662	3.6875	69.85	2.75	6.4	6.4	2200	2800	340	450	EE649239/649310	0.38	1.58	0.87	124	108
609.6	24	787.4	31	93.662	3.6875	93.662	3.6875	69.85	2.75	6.4	6.4	2080	5250	340	450	KEE649240/K649310	0.37	1.6	0.9	125	112
635	25	736.6	29	57.15	2.25	53.975	2.125	41.275	1.625	3.3	3.3	855	2640	350	470	80780/80720	0.44	1.35	0.8	124	37.3
660.4	26	812.8 939.8	32 37	95.25 136.525	3.75 5.375	95.25 127.08	3.75 5.0031	73.025 98.5	2.875 3.878	6.4 6.4	6.4 6.4	1920 3700	5550 8100	310 260	420 360	L281147/L281110 306/660.4	0.33 0.4	1.8 1.5	1 0.8	123 167	106 288
679.45	26.75	901.7	35.5	142.875	5.625	142.875	5.625	111.125	4.375	6.4	9.7	3550	8900	260	360	LM281849/LM281810	0.33	1.8	1	149	243
682.625	26.875	965.2 1080	38 42.5197	185.738 200	7.3125 7.874	185.810 195	7.3154 7.6772	142.950 142	5.628 5.5906	6.4 12	6.4 12	5050 6650	12480 13100	240 200	340 300	306/682 X4-2 306/682 X4-3	0.33 0.43	1.8 1.4	1 0.8	169 209	419 641
685.8	27	876.3	34.5	93.662	3.6875	92.075	3.625	69.85	2.75	6.4	6.4	2100	4950	280	380	EE655270/655345	0.43	1.4	0.8	148	399

Note: \* stand for the maximum value of ID or OD; SP means the nonstandard assembly chamfer.

# Inch Double Row Tapered Roller Bearings

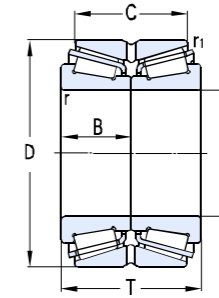
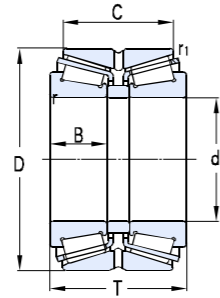

Basic dimensions												Basic load ratings		Limit speed		Designations	Calculation factor				Weight
d		D		T		B		C		rmin	r1min	Cr	Cor	Grease	Oil		e	Y1	Y2	Yo	
mm	in	mm	in	mm	in	mm	in	mm	in	mm		KN		r/min							Kg
38.1	1.5	80.035	3.150984	57.15	2.25	23.698	0.933	44.958	1.77	0.8	0.8	131	194	4800	6400	K27880/K27820D	0.56	1.2	1.79	1.18	1.33
47.625	1.875	96.838	3.813	50	1.969	21.946	0.864	39.75	1.565	0.8	0.3	147	216	3700	5000	K386A/K382A/DB	0.35	2.07	3.08	2.02	1.58
52.388	2.0625	112.712	4.4375	65.088	2.5625	26.909	1.0594	46.038	1.8125	3.5	1.5	168	238	3600	4800	K55206/K55444D	0.88	0.76	1.14	0.75	2.87
57.15	2.25	107.95	4.25	65.09	2.563	29.317	1.154	53.975	2.125	2.3	0.8	211	292	3500	4700	K462/K452D	0.32	2.09	3.11	2.04	2.3
63.5	2.5	110	4.3307	60.33	2.3752	21.996	0.866	18.824	0.7411	1.5	0.5	156	242	3200	4300	K390A/K394A+K390A/K394AB/DB	0.4	1.68	2.5	1.64	2.22
65*		110*		62		28		51		3	0.6	224	362	3200	4300	KJM511946/KJM511910/DB	0.4	1.68	2.5	1.64	2.25
		120*		86		38.5		72		3	0.6	320	500	3100	4100	KJH211749/KJH211710/DB	0.34	2	2.98	1.96	3.89
69.85	2.75	146.05	5.75	91.516	3.603	39.688	1.5625	59.766	2.353	3.5	1	370	515	3000	3500	KH913849/KH913810/DB	0.78	0.86	1.28	0.84	4.86
76.2	3	180.975	7.125	114.3	4.5	53.183	2.094	77.79	3.063	3.5	0.5	335	420	1900	2600	H917840-90010	0.73	0.92	1.37	0.9	13.6
85.136	3.3518	139.992	5.5115	80.962	3.1875	80.134	3.1549	28.575	1.125	0.8	3.3	300	520	1900	2500	K579TD/K572	0.4	1.67	2.49	1.63	4.8
90*		147*		127		40		112		7	0.5	395	605	1800	2400	KHM218248/KHM218210/DB	0.33	2.03	3.02	1.98	6.88
92.075	3.625	152.4	6	82.55	3.25	36.322	1.43	63.5	2.5	3.5	0.8	380	585	1900	2500	598/592D	0.44	1.52	2.27	1.49	5.59
95.25	3.75	149.225	5.875	66.672	2.6249	28.971	1.1406	52.388	2.0625	3.5	0.8	260	490	1900	2500	42376/42587D	0.49	1.37	2.04	1.34	4.05
96.838	3.8125	188.912	7.4375	107.95	4.25	46.038	1.8125	69.85	2.75	3.5	1	270	345	1600	2200	K90381/K90744/DB	0.87	0.78	1.16	0.76	12.2
100.211	3.9453	168.275	6.625	95.25	3.75	95.25	3.75	30.162	1.1875	0.8	3.3	370	700	1800	2400	K688TD/K672	0.47	1.43	2.14	1.4	8.29
101.6	4	168.275	6.625	92.075	3.625	1.625	3.75	69.85	2.75	3.5	0.8	370	700	1800	2400	K687/K672D	0.47	1.43	2.14	1.4	7.43
		200.025	7.875	115.888	4.563	49.212	1.937	80.216	3.158	3.5	2.3	600	940	1600	2200	K98400/K98789D	0.63	1.07	1.59	1.04	13
107.95	4.25	165.1	6.5	88.9	3.5	44.514	1.7525	63.5	2.5	3.5	0.8	330	640	1800	2400	KNA56425SW/K56650D	0.5	1.36	2.02	1.33	6.37
110*		165*		80		35		62.413	2.457	3	0.8	335	640	1800	2400	JM822049-90N01	0.5	1.36	2.02	1.33	5.74
110	4.3307	180	7.0866	103	4.0551	103	4.0551	85		3	0.6	545	1020	1600	2200	KJHM522649/KJHM522610T103/DB	0.4	1.69	2.51	1.65	9.81

# Inch Double Row Tapered Roller Bearings

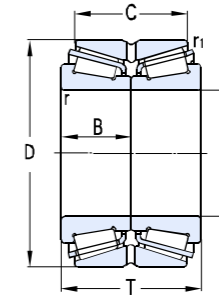
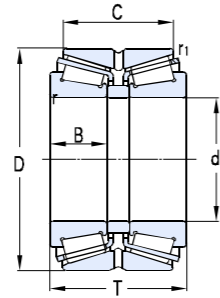

Basic dimensions												Basic load ratings		Limit speed		Designations	Calculation factor				Weight
d		D		T		B		C		rmin	r1min	Cr	Cor	Grease	Oil		e	Y1	Y2	Yo	
mm	in	mm	in	mm	in	mm	in	mm	in	mm	mm	KN		r/min							Kg
111.125	4.375	214.312	8.4375	115.888	4.5625	52.388	2.0625	84.138	3.3125	3.5	1.5	670	1100	1500	2000	KH924045/KH924010D	0.67	1	1.49	0.98	17.7
114.3	4.5	177.8	7	92.075	3.625	41.275	1.625	69.85	2.75	3.5	0.8	405	675	1600	2100	K64450/K64700D	0.52	1.29	1.92	1.26	8.01
		190.5	7.5	106.365	4.1876	49.212	1.937	80.962	3.1875	3.5	1.5	525	965	1600	2100	K71450/K71751D	0.42	1.62	2.42	1.59	11.3
		212.725	8.375	142.875	5.625	66.675	2.625	117.475	4.625	7	1.5	810	1390	1500	2000	K938/K932CD	0.33	2	3	2	20.8
120.65		174.625	6.875	77.787	3.062	36.512	1.437	61.912	2.437	3.5	0.8	360	730	1500	1800	KM224749/KM224710D	0.33	2	3	2	11.3
124.943	4.919	234.95	9.25	142.875	5.625	63.5	2.5	114.3	4.5	6.4	1.5	885	1620	1300	1600	K95491/K95927D	0.37	1.83	2.72	1.79	26.9
127	5	182.562	7.1875	72.6	2.8583	72.6	2.8583	33.338	1.3125	1.5	3.3	375	815	1200	1500	K48290DW/K48220	0.31	2.21	3.29	2.16	6.38
		228.6	9	115.888	4.5625	49.428	1.946	84.138	3.3125	3.5	2.3	790	1350	1200	1500	KHM926747/KHM926710D	0.74	0.92	1.36	0.9	19.1
		234.95	9.25	142.875	5.625	63.5	2.5	114.3	4.5	6.4	1.5	885	1620	1200	1500	K95500/K95927D	0.37	1.83	2.72	1.79	26
127.792	5.0312	288.6	11.3622	115.888	4.5625	49.428	1.946	84.138	3.3125	3.5	2.3	790	1350	1200	1500	KHM926749/KHM926710D	0.74	0.92	1.36	0.9	18.8
133.35	5.25	196.85	7.75	92.075	3.625	92.075	3.625	38.1	1.5	1.5	3.3	590	1250	1200	1500	K67390D/K67322	0.34	1.96	2.92	1.92	9.68
136.525	5.375	215.9	8.5	123.825	4.875	123.825	4.875	34.925	1.375	1.5	3.3	550	1020	1200	1500	K74539TD/K74850	0.32	2.12	3.15	2.07	9.9
		228.6	9	123.825	4.875	57.15	2.25	98.425	3.875	3.5	1.5	705	1350	1200	1500	K896/K892D	0.42	1.61	2.39	1.57	19.9
139.7	5.5	200.025	7.875	77.788	3.0625	75.408	2.9688	34.13	1.3437	0.8	3.3	475	955	1200	1500	K48680D/K48620	0.34	2.01	2.99	1.96	8.18
		215.9	8.5	106.362	4.187	47.181	1.858	80.962	3.187	3.5	1.5	550	1020	1200	1600	K74550/K74851CD	0.32	2.12	3.15	2.07	9.94
		236.538	9.3125	131.763	5.188	56.642	2.23	106.363	4.1875	3.6	1.6	700	1390	1200	1500	82550/82932D	0.44	1.52	2.27	1.49	23.4
		244.475	9.625	107.95	4.25	53.975	2.125	79.375	3.125	3.5	1.5	610	1100	1200	1500	NA81550/81963D	0.35	2.07	3.08	2.02	19.3
142.875	5.625	200.025	7.875	87.315	3.438	39.688	1.5625	73.025	2.875	3.5	0.8	430	1030	1300	1700	48685/48620D	0.34	2.01	2.99	1.96	8.15
		200.025	7.875	93.665	3.688	46.832	1.8438	75.025	2.9537	3.5	0.8	430	1030	1300	1700	NA48685SW/48620D	0.34	2.01	2.99	1.96	8.82
		236.538	9.3125	131.763	5.188	56.642	2.23	106.363	4.1875	3.6	1.6	715	1400	1200	1500	82562/82932D	0.36	1.88	2.8	1.84	23.3
147.638	5.8125	241.3	9.5	133.35	5.25	132.334	5.21	44.45	1.75	3.3	1.5	700	1400	1200	1500	K82581TD/K82950	0.44	1.52	2.27	1.49	32.6
152.4	6	222.25	8.75	100.01	3.9374	46.83	1.8437	76.2	3	3.5	0.8	590	1200	1300	1700	M231649/M231610CD	0.33	2	3	2	12.2
		254	10	142.875	5.625	66.675	2.625	111.125	4.375	7	1.5	1110	1850	940	1300	K99600/K99102CD	0.41	1.66	2.47	1.62	26.9
		298.45	11.75	107.95	4.25	111.125	4.375	44.45	1.75	3.3	3.3	1090	1720	940	1300	EE517060D/517117	0.33	2.05	3.05	2	35.7
160.325	6.312	288.925	11.375	142.875	5.625	63.5	2.5	111.125	4.375	7	1.5	1170	2170	940	1300	KHM237532/KHM237510D	0.33	2.07	3.09	2.03	37.2



# Inch Double Row Tapered Roller Bearings

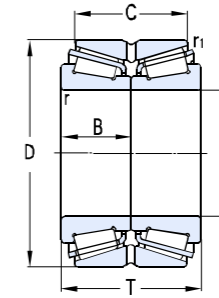
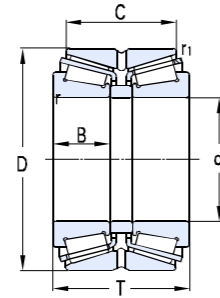

Basic dimensions												Basic load ratings		Limit speed		Designations	Calculation factor				Weight
d		D		T		B		C		rmin	r1min	Cr	Cor	Grease	Oil		e	Y1	Y2	Yo	
mm	in	mm	in	mm	in	mm	in	mm	in	mm		KN		r/min							Kg
161	6.3386	231.775	9.125	84.138	5.625	63.5	2.5	111.125	4.375	7	1.5	1170	2170	940	1300	KHM237532/KHM237510D	0.33	2.07	3.09	2.03	37.2
165.1	6.5	225.425	8.875	95.25	3.75	47.816	1.8825	69.85	2.75	3.5	0.8	445	1130	1150	1400	KNA46790SW/K46720D	0.38	1.78	2.65	1.74	10.4
		288.925	11.375	142.875	5.625	63.5	2.5	111.125	4.375	7	1.5	1080	1940	1000	1200	KHM237535/KHM237510CD	0.32	2.11	3.14	2.06	36.5
168.275	6.625	330.2	13	184.15	7.25	79.375	3.125	120.65	4.75	6.4	1.5	1500	2370	840	1100	KH936349/KH936310D	0.81	0.8	1.2	0.8	63.4
170*		230*		87		38		71		3	0.6	495	1100	1000	1300	KJHM534149/KJHM534110/DB	0.38	1.76	2.62	1.72	9.4
		240		101		44.5		83		3	0.8	685	1350			KJM734449/KJM734410/DB	0.44	1.52	2.27	1.49	13.2
174.625	6.875	247.65	9.75	103.188	4.0625	47.625	1.875	84.138	3.3125	3.5	0.8	710	1500	940	1300	K67787/K67720D	0.44	1.52	2.27	1.49	15.5
177.8	7	269.875	10.625	119.062	4.687	55.562	2.1875	93.662	3.6875	3.5	1.5	795	1720	940	1300	KM238840/KM238810D	0.33	2.03	3.02	1.98	22
		282.575	11.125	107.95	4.25	54.166	2.1325	79.375	3.125	3.5	1.5	700	1450	940	1300	KNA87700SW/K87112D	0.41	1.66	2.47	1.62	24
		288.925	11.375	142.875	5.625	63.5	2.5	111.125	4.375	7	1.5	1170	2170	940	1300	KHM237545/KHM237510D	0.33	2.07	3.09	2.03	36.2
		288.925	11.375	142.875	5.625	63.5	2.5	111.125	4.375	7	1.5	1010	2020	940	1300	K94700/K94114CD	0.47	1.44	2.15	1.41	34
		320.675	12.625	185.738	7.3125	85.725	3.375	138.112	5.4375	3.5	1.5	1590	2830	840	1100	KH239640/KH239612D	0.32	2.12	3.15	2.07	58.9
		320.675	12.625	185.738	7.3125	85.725	3.375	138.112	5.4375	3.5	1.5	1400	2760			KEE222070/K222127CD	0.4	1.68	2.50	1.64	61.5
		320.675	12.625	185.738	7.3125	85.725	3.375	138.112	5.4375	3.5	1.5	1590	2830	840	1100	KH239640/KH239612D	0.32	2.12	3.15	2.07	58.9
180.975		288.925		158.75		158.75		47.625		1.5	3.5	985	2020	940	1300	K94713TD/K94113	0.47	1.44	2.15	1.41	39.8
187.325	7.375	269.875	10.625	119.062	4.687	55.562	2.187	93.662	3.687	3.5	1.5	795	1720	940	1300	KM238849/KM238810DC	0.33	2.04	3.03	1.99	19.3
		320.675	12.625	185.738	7.3125	85.725	3.375	138.112	5.4375	5.5	1.5	1590	2830	850	1100	KH239649/KH239612CD	0.32	2.12	3.15	2.07	55.4
190	7.48	260	10.236	102	4.016	44	1.732	83	3.268	8	1	630	1460	940	1300	KJM738249A/KJM738210/DB	0.477	1.41	2.11	1.38	14.1
190.5	7.5	266.7	10.5	90.488	3.5625	89.695	3.5313	38.1	1.5	1.5	3.5	615	1520	940	1300	K67885DW/K67820	0.48	1.41	2.11	1.38	15.9
		266.7	10.5	109.538	4.313	54.961	2.1638	84.138	3.3125	3.5	0.8	615	1520	940	1300	KNA67885SW/K67820D	0.48	1.41	2.11	1.38	15.3
		368.3		193.675		88.897		136.525		6.4	1.5	1680	2900	700	950	KEE420751/K421451CD	0.4	1.68	2.50	1.64	84
200.025	7.875	317.5	12.5	146.05	5.75	63.5	2.5	111.125	4.375	4.3	1.5	1035	2270	840	1100	K93787/K93127D	0.52	1.29	1.92	1.26	40.8
		384.175	15.125	238.125	9.375	112.712	4.4375	193.675	7.625	6.4	1.5	2320	5080	690	920	KH247535/KH247510CD	0.33	2.03	3.02	1.98	112
203.2	8	276.225	10.875	95.25	3.75	47.816	1.8825	73.025	2.875	3.5	0.8	610	1440	940	1300	KLM241149NW/KLM241110D	0.32	2.12	3.15	2.07	15.3
		317.5	12.5	146.05	5.75	63.5	2.5	111.125	4.375	4.3	1.5	1035	2270	840	1100	K93800/K93127D	0.52	1.29	1.92	1.26	39.8
		368.3	14.5	158.75	6.25	152.4	6	152.4	6	3.3	3.3	1780	3300	840	1100	EE420800D/421450	0.4	1.7	2.5	1.6	75.2

# Inch Double Row Tapered Roller Bearings

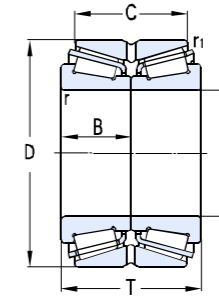
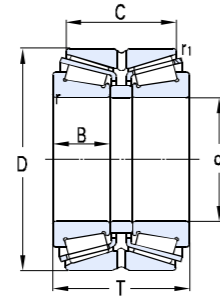

Basic dimensions												Basic load ratings		Limit speed		Designations	Calculation factor				Weight
d		D		T		B		C		rmin	r1min	Cr	Cor	Grease	Oil		e	Y1	Y2	Yo	
mm	in	mm	in	mm	in	mm	in	mm	in	mm		KN		r/min							Kg
		368.3	14.5	193.675	7.625	88.897	3.4999	136.525	5.375	3.3	1.5	1680	2900	840	1000	EE420801/421451CD	0.4	1.69	2.52	1.65	78.8
212.725		285.75	11.25	98.425	3.875	46.038	1.8125	98.52	3	3.5	0.8	630	1630	670	900	KLM742745/KLM742710CD	0.48	1.41	2.09	1.38	16.9
220.662	8.6875	314.325	12.375	131.762	5.1875	61.912	2.4375	106.362	4.1875	6.4	1.5	1050	2450	760	1000	KM244249/KM244210D	0.33	2.03	3.02	1.98	30.5
		314.325	12.375	131.762	5.1875	61.912	2.4375	106.362	4.1875	6.4	1.5	1050	2300	760	1000	M244249/M244210CD	0.33	2.03	3.02	1.98	30.5
234.95	9.25	327.025	12.875	93.662	3.688	93.662	3.6875	36.512	1.437	1.5	3.3	805	1860	760	1000	8576DW/8520	0.41	1.66	2.47	1.62	25
		327.025	12.875	114.3	4.5	52.388	2.0625	82.55	3.25	6.4	1.5	790	1830	760	1000	K8575/K8520CD	0.41	1.66	2.47	1.62	26.9
		348.175	13.708	238.125	9.375	112.712	4.4375	193.675	7.625	6.4	1.5	2320	5080	750	950	KH247549/KH247510D	0.33	2.03	3.02	1.98	111
237.33		358.775	14.125	152.4	6	71.438	2.8125	117.475	4.625	6.4	1.5	1530	3090	750	950	KRM249736/M249710CD	0.33	2.03	3.02	1.98	53.2
228.6	9	327.025	12.875	114.3	4.5	52.388	2.0625	82.55	3.25	6.4	1.5	790	1830	760	1000	K8573/K8520CD	0.41	1.66	2.47	1.62	28.9
		355.6	14	152.4	6	69.85	2.75	114.3	4.5	6.4	1.5	1300	2700	760	1000	KHM746646/KHM746610CD	0.47	1.44	2.15	1.41	52.4
		355.6	14	152.4	6	69.85	2.75	111.125	4.375	6.8	1.5	1200	2500	760	1000	KEE130902/K131401CD	0.33	2.03	3.02	1.98	50.2
		488.95	19.25	254	10	111.125	4.375	152.4	6	6.4	1.5	2800	4450	630	840	HH949549/HH949510D	0.94	0.7	1.1	0.7	203
		488.95	19.25	254	10	120.65	4.75	196.85	7.75	6.4	1.5	2910	5650	630	840	KEE295950/K295192D	0.31	2.18	3.24	2.13	217
241.3	9.5	327.025	12.875	114.3	4.5	52.388	2.0625	82.55	3.25	6.4	1.5	790	1830	760	1000	K8578/K8520DC	0.41	1.66	2.47	1.62	25
		406.4	16	215.9	8.5	100.012		184.15		6.4	1.5	2390	4950	760	1000	KH249148/KH249111CD	0.33	2.03	3.02	1.98	110
		444.5	17.5	209.55	8.25	100.012	3.9375	158.75	6.25	6.4	1.5	2480	4650	760	1000	KEE923095/K923176D	0.34	2	2.98	1.96	135
247.65	9.75	406.4	16	215.9	8.5	219.075	8.625	93.662	3.6875	3.3	6.4	2900	6400	760	1000	KHH249949D/KHH249910	0.33	2.03	3.15	1.98	114
249.25	9.813	381	15	171.45	6.75	76.2	3	127	5	6.4	1.5	1240	2960	690	920	KEE126098/K126151CD	0.52	1.31	1.94	1.28	63.4
254	10	347.662	13.6875	101.6	4	50.99	2.0075	69.85	2.75	3.5	1.5	825	1740	690	920	KLM249747NW/KLM249710D	0.33	2.03	3.02	1.98	25.3
		358.775	14.125	152.4	6	71.438	2.8125	117.475	4.625	3.5	1.5	1530	3090	690	920	KRM249749/M249710CD	0.33	2.03	3.02	1.98	46.9
		393.7	15.5	157.162	6.1875	69.85	2.75	109.538	4.3125	6.4	1.5	1290	2830	690	920	KEE275100/K275156D	0.4	1.68	2.5	1.64	66.4
		422.275	16.625	178.592	7.0312	79.771	3.1406	139.7	5.5	6.8	1.5	2190	4000	580	770	HM252343/HM252310D	0.33	2	3	2	98
		431.724	16.997	173.038	6.813	86.519	3.4063	128.588	5.0625	6.4	1.6	1130	1760	630	840	NA551002/551701D	0.33	2.05	3.05	2	93.1
		438.15	17.25	165.1	6.5	165	6.4961	63.5	2.5	3.3	6.4	2200	3900	580	770	EE738101DW/738172	0.35	1.92	2.86	1.88	104
		444.5	17.5	133.35	5.25	133.35	5.25	50.8	2	3.3	6.4	2070	3600	580	770	EE822101D/822175	0.33	2.06	3.06	2.01	88
		533.4	21	276.224	10.875	120.65	4.75	165.1	6.5	6.4	1.5	3350	5400	530	670	HH953749/HH953710D	0.94	1.7	1.1	0.7	258
260.35	10.25	365.125	14.375	130.175	5.125	58.738	2.3125	98.425	3.875	6.4	1.5	975	2200	670	900	EE134102/134144D	0.37	1.8	2.69	1.76	37.3

# Inch Double Row Tapered Roller Bearings

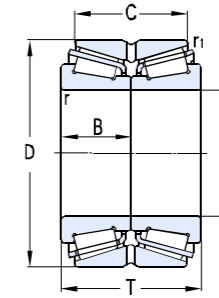
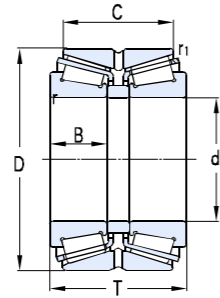

Basic dimensions												Basic load ratings		Limit speed		Designations	Calculation factor				Weight
d		D		T		B		C		rmin	r1min	Cr	Cor	Grease	Oil		e	Y1	Y2	Yo	
mm	in	mm	in	mm	in	mm	in	mm	in	mm		KN		r/min							Kg
		400.05	15.75	155.58	6.1252	67.47	2.6563	107.95	4.25	9.7	1.5	1260	2500	670	900	0.39	1.71	2.54	1.67	61.7	
		406.4	16	155.575	6.125	152.4	6	66.675	2.625	3.3	6.4	1620	3520	670	900	0.33	2.03	3.02	1.98	79.9	
		422.275	16.625	178.592	7.0312	79.771	3.1406	139.7	5.5	6.8	1.5	1760	3750	670	900	0.33	2.03	3.02	1.98	89.1	
		444.5	17.5	196.85	7.75	196.85	7.75	73.025	2.875	6.4	5	2560	5050	670	900	0.55	1.23	1.83	1.2	126	
266.7	10.5	352.425	13.875	107.95	4.25	54.166	2.1325	82.55	3.25	6.4	1.5	840	1780	670	900	0.32	2.12	3.15	2.07	25.3	
		355.6	14	127	5	57.15	2.25	101.6	4	3.5	1.5	1080	2700	670	900	0.36	1.88	2.79	1.83	32.8	
269.875	10.625	381	15	136.525	5.375	136.525	5.375	57.15	2.25	3.3	3.3	1760	3700	630	840	0.33	2.03	3.02	1.98	51.5	
273.05	10.75	393.7	15.5	157.162	6.1875	69.85	2.75	109.538	4.3125	6.4	1.5	1290	2830	600	800	0.4	1.68	2.5	1.64	56.3	
279.4	11	457.2	18	244.475	9.625	244.475	9.625	106.362	4.1875	1.5	6.4	3850	7400	600	800	0.33	2.03	3.02	1.98	164	
		469.9	18.5	200.025	7.875	93.662	3.6875	149.225	5.875	9.7	1.5	2740	5000	590	780	0.38	1.79	2.67	1.75	132	
		488.95	19.25	254	10	120.65	4.75	196.85	7.75	1.5	1.3	2910	5650	580	770	0.31	2.18	3.45	2.13	188	
279.578	11.007	380.898		117.475		117.475		49.212		1.5	3.3	1130	2830	650	900	0.43	1.57	2.34	1.53	39.2	
279.982	11.023	380.898	14.996	139.7	5.5	65.088	2.563	107.95	4.25	3.5	1.5	1035	2830	620	850	0.43				41.6	
280.192	11.0312	406.4	16	149.226	5.875	67.673	2.6643	117.475	4.625	6.8	1.5	1320	2950	600	800	0.39	1.71	2.54	1.67	56.7	
285.75		380.898		139.7		65.088		107.95		3.5	1.5	1130	2830	600	800	0.43	1.57	2.34	1.53	39.2	
288.925	11.375	406.4	16	144.462	5.688	144.462	5.6875	60.325	2.375	3.3	1.5	1790	4200	580	770	0.34	2	2.98	1.96	61.66	
		406.4	16	144.462	5.688	144.462	5.6875	60.325	2.375	3.3	3.3	1720	4150	580	770	0.34	2	2.98	1.96	63.3	
		406.6	16	165.1	6.5	77.788	3.0625	130.175	5.125	6.4	1	1720	4150	580	770	0.34	2	2.98	1.96	64.1	
		406.4	16	144.462	5.688	144.462	5.6875	60.325	2.375	3.3	3.3	1720	4150	580	770	0.34	2	2.98	1.96	60.5	
300.038	11.8125	422.275	16.625	150.812	5.9375	150.812	5.9375	63.5	2.5	3.3	3.3	1770	4050	580	770	0.34	2	2.98	1.96	56.4	
		422.275	16.625	174.625	6.875	82.55	3.25	136.525	5.375	6.4	1.5	1720	4050	580	770	0.34	2	2.98	1.96	69.7	
303.212	11.9375	495.3	19.5	263.525	10.375	263.525	10.375	114.3	4.5	3.3	6.4	3900	8850	460	600	0.33	2	3	2	215	
304.8	12	393.7	15.5	107.95	4.25	54.166	2.1325	82.55	3.25	6.4	1.5	1070	2330	580	770	0.33	2.04	3.04	2	30.1	
		393.7	15.5	107.95	4.25	50.8	2	82.55	3.25	6.4	1.5	1070	2330	580	770	0.33	2.04	3.04	2	30.5	
		412.75	16.25	123.825	4.875	53.975	2.125	92.075	3.625	6.4	1.5	1060	2350	580	770	0.43	1.6	2.3	1.6	42.4	

# Inch Double Row Tapered Roller Bearings

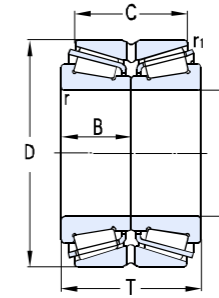
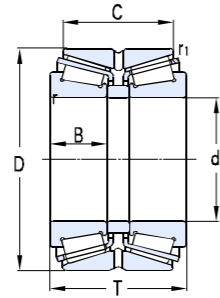

Basic dimensions												Basic load ratings		Limit speed		Designations	Calculation factor				Weight
d		D		T		B		C		rmin	r1min	Cr	Cor	Grease	Oil		e	Y1	Y2	Yo	
mm	in	mm	in	mm	in	mm	in	mm	in	mm		KN		r/min							Kg
		444.5	17.5	146.05	5.75	61.912	2.4375	98.425	3.875	8	1.5	1240	2770	550	700	EE291201/291751D	0.38	1.79	2.67	1.75	64.9
		495.3	19.5	168.595	6.638	74.612	2.9375	127	5	6.4	1.5	1850	3400	500	660	EE941205/941953D	0.4	1.68	2.5	1.64	115
		495.3	19.5	196.85	7.75	92.075	3.5463	146.05	5.75	16	1.5	2300	5000	500	660	EE724120/724196CD-3	0.4	1.68	2.5	1.64	139
		501.65	19.75	161.922	6.3749	161.925	6.375	61.117	2.4062	3.3	6.4	2800	4700	500	700	HM258949D/HM258910	0.33	2	3	2	129
305.034	12.009	499.948	19.683	200.025	7.875	200.025	7.875	63.5	2.5	3.3	6.4	2430	5000	460	600	KHM959741DW/KHM959710	0.88	0.77	1.15	0.75	149
305.054	12.01	499.949	19.683	200.025	7.875	200.025	7.875			6.4	6.4	1870	3650	460	600	M959442D/M959410	1.17	0.58	0.86	0.56	145
305.07	12.0106	560	22.0472	200	7.874	200	7.874			3.3	6	2850	5250	440	540	3706/305X4-1	0.88	0.77	1.15	0.8	199
311.15	12.25	558.8	22	190.5	7.5	82.55	3.25	111.125	4.375	9.7	3.3	2130	4140	440	540	EE148122/148220D	0.88				184
317.5	12.5	444.5	17.5	146.05	5.75	61.912	2.4375	98.425	3.875	8	1.5	1240	2770	490	650	KEE291250/K291751CD	0.38	1.79	2.67	1.75	59.0
		447.675	17.625	158.75	6.25	158.75	6.25	158.75	6.25	3.3	3.3	1810	4150	490	650	HM259049D/HM259010	0.33	2.03	3.02	1.98	80.7
		447.675	17.625	180.975	7.125	85.725	3.375	146.05	5.75	3.5	1.5	1800	4650	490	650	KHM259049/KHM259010CD	0.33	2	3	2	85.4
330.2	13	482.6	19	177.8	7	80.167	3.1562	127	5	3.3	1.5	2180	4900	480	630	EE526132/526191D	0.4	1.7	2.5	1.6	101
333.375	13.125	469.9	18.5	166.688	6.5625	166.688	6.5625	71.438	2.8125	3.3	3.3	2470	5900	480	630	HM261049DW/HM261010	0.33	2	3	2	92.8
		469.9	18.5	190.5	7.5	90.488	3.5625	152.4	6	6.4	1.5	2470	5900	480	630	HM261049/HM261010CD	0.33	2	3	2	98.2
342.9	13.5	457.098	17.996	142.875	5.625	63.5	2.5	101.6	4	3.3	1.5	1300	3550	480	630	KLM961548/KLM961511D	0.7	0.97	1.44	0.94	44.8
		457.098	17.996	142.875	5.625	63.5	2.5	104.775	4.125	3.6	1.6	1300	3500	480	630	KLM961548A6/KLM961511DX2A6	0.7	0.97	1.44	0.94	45
		533.4	21	139.7	5.5	146.05	5.75	50.8	2	3.3	3.3	2300	4350	420	560	EE971355D/972100	0.33	2	3	2	116
		533.4	21	174.625	6.875	76.2	3	123.825	4.875	4.8	1.5	2300	4350	420	560	EE971354/972103D	0.33	2	3	2	128
343.154		450.85		189.35		66.675		52.388		8.5	1	1320	3500	480	630	KLM361649A/KLM361610/DB	0.35	1.93	2.87	1.89	59.2
343.052	13.506	457.098	17.996	122.238	4.8125	122.238	4.8125	49.212	1.9375	1.5	3.3	1480	3350	480	630	LM761649DGW/LM761610	0.48	1.4	2.1	1.4	53.6
346.075	13.625	488.95	19.25	104.775	4.125	95.25	3.75			6.4	1.5	1090	2680	480	630	3706/346X4	0.5	1.35	2	1.3	62.3
		488.95	19.25	174.625	6.875	174.625	6.875	74.612	2.937	3.3	3.3	2420	5800	480	630	HM262749TD/HM262710D	0.34	1.99	2.96	1.95	102
		488.95	19.25	174.625	6.875	174.625	6.875	74.612	2.937	3.3	3.3	2400	5800	480	630	KHM262749D/KHM262710	0.33	2	3	2	97.8
		488.95	19.25	200.025	7.875	95.25	3.75	158.75	6.25	6.4	1.5	2560	6450	480	630	HM262749SH/HM262710CDSH	0.33	2	3	2	114
		488.95	19.25	200.025	7.875	95.25	3.75	158.75	6.25	6.4	1.5	2400	5800	480	630	HM262749/HM262710D	0.33	2	3	2	108

# Inch Double Row Tapered Roller Bearings

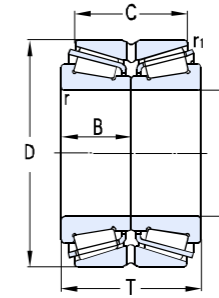
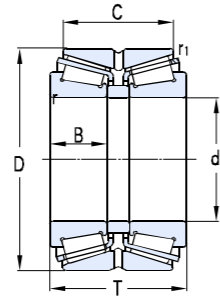

Basic dimensions												Basic load ratings		Limit speed		Designations	Calculation factor				Weight
d		D		T		B		C		rmin	r1min	Cr	Cor	Grease	Oil		e	Y1	Y2	Yo	Kg
mm	in	mm	in	mm	in	mm	in	mm	in	mm	mm	KN		r/min							
355.6	14	444.5	17.5	136.524	5.375	60.325	2.375	111.125	4.375	3.5	1.5	1110	3450	460	600	L163149/L163110CD KEE231400/K231976CDX2 EE333140/333203CD	0.31	2.2	3.27	2.15	46.1
		501.65	19.75	145.05	5.7106	61.413	2.4178	107.95	4.25	6.4	1.5	1410	3450	420	560		0.44	1.53	2.28	1.5	83.4
		514.35	20.25	193.675	7.625	84.138	3.3125	152.4	6	6.4	1.5	2150	4950	410	540		0.37	1.8	2.7	1.8	120
368.249	14.498	523.875	20.625	214.312	8.4375	101.6	4	169.862	6.6875	6.4	1.5	3000	7400	410	540	HM265049/HM265010CD	0.33	2	3	2	141
368.3	14.5	523.875	20.625	185.738	7.3125	185.738	7.3125	79.375	3.125	3.3	6.4	3000	6200	410	540	HM265049DW/HM265010 EE181454DW/182350 EE181453/182351D	0.33	2	3	2	128
		596.9	23.5	165.1	6.5	158.75	6.25	60.325	2.375	6.4	6.4	3000	5800	400	520		0.4	1.7	2.5	1.6	159
		596.9	23.5	203.2	8	92.075	3.625	133.35	5.25	9.7	2.3	2640	5200	400	520		0.42	1.62	2.42	1.59	191
374.65	14.75	501.65	19.75	130.175	5.125	120.65	4.75	50.8	2	1.5	3.3	1600	4000	460	600	KLM765149DW/KLM765110	0.47	1.44	2.14	1.4	69.4
381	15	590.55	23.25	244.475	9.625	114.3	4.5	193.675	7.625	6.4	1.5	4500	6600	380	500	M268730/M268710D	0.33	2.03	3.02	1.98	247
384.175	15.125	546.1	21.5	193.675	7.625	193.675	7.625	82.55	3.25	3.3	6.4	3200	8200	410	540	HM266449TD/HM266410 HM266449DW/HM266410 HM266449D/HM266410 HM266448/HM266410CD	0.33	2.04	3.02	1.98	151
		546.1	21.5	193.675	7.625	193.675	7.625	82.55	3.25	3.3	6.4	3200	8200	410	540		0.33	2.04	3.02	1.98	151
		546.1	21.5	193.675	7.625	193.675	7.625	82.55	3.25	3.3	6.4	3200	8200	410	540		0.33	2.04	3.02	1.98	152
		546.1	21.5	222.25	8.75	104.775	4.125	177.8	7	6.4	1.5	3200	8200	410	540		0.33	2.04	3.02	1.98	161
385.762	15.1875	514.35	20.25	177.8	4.6378	82.55	3.25	139.7	5.5	6.4	1.5	2050	5600	450	680	LM665949/LM665910CD	0.42	1.62	2.42	1.59	100
390*		570*		180		180		63		1.5	4	2190	5230	400	520	KJM966748DW/KJM966710	0.83	0.8	1.2	0.8	158
393.7	15.5	546.1	21.5	138.112	5.4375	138.112	5.4375	53.975	2.125	1.5	6.4	2150	4650	410	540	LM767745D/LM767710/YB2	0.47	1.42	2.12	1.39	100
406.4	16	539.75	21.25	142.875	5.625			101.6	4	6.4	1.5	1620	4350	410	540	3506/406.4 3706/406.4 EE833161XD/833232/YB2	0.48	1.4	2.1	1.4	82.6
		546.1	21.5	138.113	5.4375	138.113	5.4375			1.5	6.4	2080	5000	410	540		0.48	1.4	2.1	1.4	88.6
		590.55	23.25	193.674	7.625	193.675	7.625	80.692	3.1769	3.3	6.4	3600	7100	410	540		0.33	2.03	3.02	1.98	186
408.4	16.0787	546.1	21.5	120	4.7244	98	3.8583	98	3.8583	1	3	1480	3400	410	540	3706/408.4	0.88	0.77	1.15	0.8	76.3
409.575	16.125	546.1	21.5	161.925	6.375	161.925	6.375	66.675	2.625	1.5	6.4	2800	8500	410	540	M667947D/M667910 KM667947D/KM667910 M270730/M270710CD	0.43	1.6	2.3	1.6	104
		546.1	21.5	161.925	6.375	161.925	6.375	66.675	2.625	1.5	6.4	2800	6550	410	540		0.43	1.6	2.3	1.6	104
		635	25	257.175	10.125	120.65	4.75	206.375	8.125	6.4	1.5	4650	10300	380	500		0.33	2	3	2	300
415.925	16.375	590.55	23.25	209.55	8.25	209.55	8.25	88.9	3.5	3.3	6.4	3960	8400	410	540	M268749DW/M268710 M268749/M268710DC/HE	0.33	2.03	3.02	1.98	179
		590.55	23.25	244.475	9.625	114.3	4.5	193.675	7.625	6.4	1.5	3250	8550	380	500		0.33	2.03	3.02	1.98	205

# Inch Double Row Tapered Roller Bearings

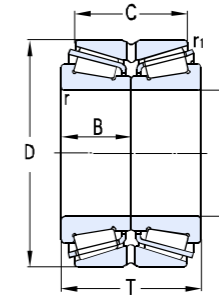
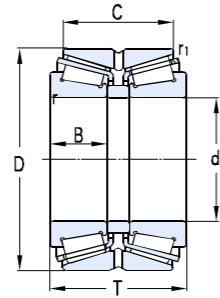

Basic dimensions												Basic load ratings		Limit speed		Designations	Calculation factor				Weight
d		D		T		B		C		rmin	r1min	Cr	Cor	Grease	Oil		e	Y1	Y2	Yo	
mm	in	mm	in	mm	in	mm	in	mm	in	mm	mm	KN		r/min							Kg
431.8	17	571.5	22.5	155.575	6.125	74.612	2.9375	111.125	4.375	3.3	1.5	1660	4200	410	540	LM869448/LM869410CD	0.55	1.24	1.84	1.21	102
447.675	17.625	635	25	223.838	8.8125	223.838	8.8125	95.25	3.75	3.3	6.4	3900	10300	360	480	KM270749D/KM270710	0.33	2	3	2	232
		635	25	257.175	10.125	120.65	4.75	206.375	8.125	6.4	1.5	4650	10300	360	480	M270749/M270710CD	0.33	2	3	2	247
457.2	18	596.9	23.5	165.1	6.5	73.025	2.875	120.65	4.75	9.7	1.5	1860	5000	380	500	EE244180/244236CD	0.4	1.67	2.48	1.63	109
479.425	18.875	679.45	26.75	276.225	10.875	128.588	5.0625	222.25	8.75	6.4	1.5	4180	10900	320	440	KM272749/KM272710D	0.33	2.03	3.02	1.98	307
482.6	19	615.95	24.25	184.15	7.25	85.725	3.375	146.05	5.75	6.4	1.5	2540	7510	360	480	LM272249/LM272210D	0.33	2.03	3.02	1.98	130
488.95	19.25	634.873	24.995	180.975	7.125	84.138	3.3125	136.525	5.375	6.4	1.5	2230	6250	360	480	LM772748/LM772710CD	0.47	1.43	2.12	1.4	138
489.026	19.253	634.873	24.995	152.4	6	152.4	6	63.5	2.5	3.3	3.3	2700	7300	360	480	EE243193D/243250	0.35	1.9	2.9	1.8	129
		634.873	24.995	177.8	7	80.962	3.1875	142.875	5.625	6.4	1.5	2700	7300	360	480	EE243192/243251D	0.35	1.9	2.9	1.8	129
498.475	19.625	634.873	24.995	177.8	7	80.962	3.1875	142.875	5.625	6.4	1.5	2700	7300	360	480	EE243196/243251D	0.35	1.9	2.9	1.8	124
501.65	19.75	673.1	26.5	184.15	7.25	184.15	7.25			3.3	6.4	3850	9600	340	450	3706/501X4	0.31	2.2	3.3	2.2	191
		711.2	28	250.825	9.875	250.825	9.875	103.363	4.0694	3.2	6.4	4500	13400	300	400	3706/500/HC	0.33	2	3	2	321
		711.2	28	292.1	11.5	136.525	5.375	231.775	9.125	6.4	1.5	4500	13400	300	400	M274149/M274110DC	0.33	2	3	2	355
505.181	19.889	838.2	33	266.7	10.5	104.775	4.125	104.775	4.125	6.4	9.7	5800	12000	280	360	EE426198D/426330	0.48	1.4	2.1	1.4	590
508	20	762	30	219.075	8.625	219.075	8.625	85.725	3.375	6.4	6.4	4650	10200	290	380	KEE531201D/K531300	0.38	1.78	2.09	1.74	347
		838.2	33	304.8	12	139.7	5.5	222.25	8.75	9.7	3.3	6300	13500	280	360	EE426200/426331CD	0.48	1.4	2.1	1.4	628
519.112	20.4375	736.6	29	258.672	10.1839	258.672	10.1839			3.3	6.4	5950	15300	300	400	3706/519X4	0.33	2	3	2	368
520.7	20.5	736.6	29	186.502	7.3426	81.758	3.2188	114.3	4.5	6.4	1.5	3000	6650	300	400	EE982051/982901CD	0.48	1.4	2.1	1.4	208
536.575	21.125	761.873	29.995	269.875	10.625	269.875	10.625	114.3	4.5	3.3	6.4	6200	15500	280	350	M276449DW/M276410	0.33	2	3	2	412
		761.873	29.995	311.15	12.25	146.05	5.75	247.65	9.75	6.4	1.5	5650	15000	280	350	M276449/M276410CD	0.33	2	3	2	426
558.5	21.9882	736.6	29	225.425	8.875	104.775	4.125	177.8	7	1.5	6.4	4400	12800	280	350	LM377449/LM377410CD/HE	0.35	1.92	2.86	1.88	256
558.8	22	736.6	29	187.328	7.3751			138.112	5.4375	6.4	1.5	3350	8200	280	350	3506/558.8	0.35	1.9	2.9	1.8	191

# Inch Double Row Tapered Roller Bearings

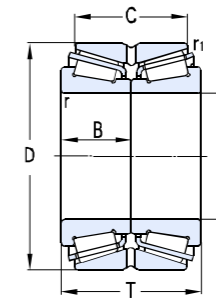
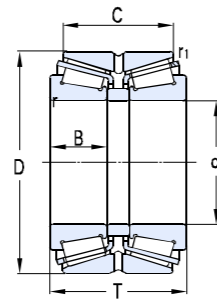

Basic dimensions												Basic load ratings		Limit speed		Designations	Calculation factor				Weight
d		D		T		B		C		rmin	r1min	Cr	Cor	Grease	Oil		e	Y1	Y2	Yo	
mm	in	mm	in	mm	in	mm	in	mm	in	mm		KN		r/min							Kg
-	-	736.6	29	196.85	7.75	196.85	7.75	80.962	3.1875	3.3	6.4	14250	11500	280	350	LM377448D/LM377410	0.35	1.9	2.9	1.8	233
		736.6	29	225.425	8.875	104.775	4.125	177.8	7	6.4	1.5	4250	11500	280	350	LM377448/LM377410CD	0.35	1.9	2.9	1.8	151
571.5	22.5	812.8	32	285.75	11.25	285.75	11.25	120.65	4.75	3.3	6.4	7700	18000	260	330	M278749DW/M278710	0.33	2	3	2	524
		812.8	32	333.375	13.125	155.575	6.125	263.525	10.375	6.4	1.5	6400	15900	260	330	M278749/M278710D	0.33	2	3	2	521
602.945	23.738	787.4	31	206.375	8.125	93.662	3.6875	158.75	6.25	6.4	1.5	4000	10500	260	330	EE649237/649311CD	0.37	1.8	2.7	1.8	181
609.6	24	787.4	31	171.45	6.75	171.45	6.75	69.85	2.75	3.3	6.4	4000	10500	260	330	EE649241D/649310	0.37	1.8	2.7	1.8	219
		787.4	31	206.375	8.125	93.662	3.6875	158.75	6.25	6.4	1.5	4000	10500	260	330	EE649240/649311CD	0.37	1.8	2.7	1.8	233
		812.8	32	190.5	7.5	82.55	3.25	146.05	5.75	6.4	3.3	3500	8700	250	310	EE743240/743321D	0.33	2	3	2	251
		820	32.2835	171.45	6.75	171.45	6.75			3.3	6.4	4000	10500	250	310	3706/609.6	0.37	1.8	2.7	1.8	266
		820	32.2835	206.375	8.125			158.75	6.25	6.4	1.5	4000	10500	250	310	3506/609.6	0.37	1.8	2.7	1.8	293
635	25	939.8	37	304.8	12	304.8	12	107.95	4.25	3.2	6.4	6270	17000	250	330	3706/635/HC-1	0.88	0.77	1.14	0.75	762
		990.6	39	339.725	13.375			212.725	8.375	6.4	6.4	8000	15800	250	320	3506/635	0.88	0.77	1.15	0.8	841
660.4	26	812.8	32	176.212	6.9375	176.212	6.9375	73.025	2.875	3.3	6.4	3500	11100	240	300	L281149D/L281110	0.33	2	3	2	194
		812.8	32	203.2	8	95.25	3.75	158.75	6.25	6.4	1.5	3080	9900	240	300	KL281148/KL281110CD	0.33	2	3	2	212
682.625	26.875	965.2	38	338.138	13.3125	338.138	13.3125	142.875	5.625	6.4	3.3	9450	24800	220	290	M282249D/M282210	0.33	2	3	2	812
685.8	27	876.3	34.5	200.024	7.875	92.075	3.625	152.4	6	6.4	1.5	3850	10500	220	290	EE655270/655346D	0.43	1.6	2.3	1.6	271

Note: \* stand for the maximum value of ID or OD; SP means the nonstandard assembly chamfer.



## WAFANGDIAN BEARING GROUP CORP., LTD

Add: No.1, Beigongji Street, Wafangdian City, Liaoning Province, China

Tel: +86 411-39118866 39118868 39118878

Fax: +86 411-39118880 39118865

P C: 116300

Email: [export@zwz-bearing.com](mailto:export@zwz-bearing.com)

Website: [//www.zwz-bearing.com](http://www.zwz-bearing.com)